



# SWISONS

SURGICALS

- Ent Surgery





¼

ZÖLLNER  
SS-10-101 -  
SS-10-1006 set for  
adults, black



SS-10-101  
Fig.1  
5.5 X 6.5 mm Ø



SS-10-102  
Fig.2  
6.5 X 7.5 mm Ø



SS-10-103  
Fig.3  
7.5 X 8.5 mm Ø



SS-10-104  
Fig.4  
8.5 X 9.5 mm Ø



SS-10-105  
Fig.5  
9.5 X 10.5 mm Ø

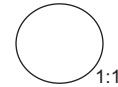

SS-10-106  
Fig.6  
10.5 X 11.5 mm Ø



¼

POLITZER  
SS-10-107 -  
SS-10-110 set for  
adults



SS-10-107  
Fig.1  
2 mm Ø



SS-10-108  
Fig.2  
3 mm Ø



SS-10-109  
Fig.3  
4 mm Ø



SS-10-110  
Fig.4  
5 mm Ø



¼

BOUCHERON  
SS-10-111 -  
SS-10-113 set for  
children



SS-10-111  
Fig.0  
3.0 mm Ø



SS-10-112  
Fig.1  
4.5 mm Ø



SS-10-113  
Fig.2  
5.5 mm Ø



¼

HARTMANN  
SS-10-114 - SS-10-117 set for  
adults



SS-10-114  
Fig.1  
4.5 mm Ø



SS-10-115  
Fig.2  
5.5 mm Ø



SS-10-116  
Fig.3  
6.5 mm Ø



SS-10-117  
Fig.4  
7.5 mm Ø



BUCK  
 SS-10-118 -  
 SS-10-133 Blunt  
 Sharp  
 165 mm - 6½"



SS-10-118  
 Fig.000



SS-10-119  
 Fig.00



SS-10-120  
 Fig.0



SS-10-121  
 Fig.1



SS-10-122  
 Fig.2



SS-10-123  
 Fig.3



SS-10-124  
 Fig.4



SS-10-125  
 Fig.5



SS-10-126  
 Fig.000



SS-10-127  
 Fig.00



SS-10-128  
 Fig.0



SS-10-129  
 Fig.1



SS-10-130  
 Fig.2



SS-10-131  
 Fig.3



SS-10-132  
 Fig.4



SS-10-133  
 Fig.5



BUCK  
 SS-10-134 -  
 SS-10-149 Curved,  
 blunt Curved, sharp  
 165 mm - 6½"



SS-10-134  
 Fig.000



SS-10-135  
 Fig.00



SS-10-136  
 Fig.0



SS-10-137  
 Fig.1



SS-10-138  
 Fig.2



SS-10-139  
 Fig.3



SS-10-140  
 Fig.4



SS-10-141  
 Fig.5



SS-10-142  
 Fig.000



SS-10-143  
 Fig.00



SS-10-144  
 Fig.0



SS-10-145  
 Fig.1



SS-10-146  
 Fig.2



SS-10-147  
 Fig.3



SS-10-148  
 Fig.4



SS-10-149  
 Fig.5

Picture Show The Outer Diameter



LANGENBECK  
SS-10-150  
Blunt  
130 mm - 5"



JANSEN  
SS-10-151  
Sharp  
170 mm - 6 3/4"



GROSS  
SS-10-1  
Sharp, not fenestrated  
120 mm - 4 3/4"



SS-10-153  
Blunt, fenestrated  
120 mm - 4 3/4"



JANSEN  
SS-10-154  
Sharp  
160 mm - 6 1/4"



BILLEAU  
SS-10-155 - SS-10-157  
165 mm - 6½"

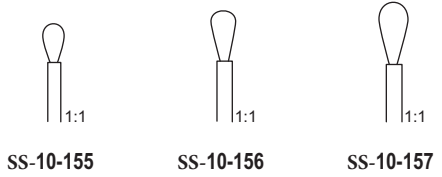

LUCAE  
SS-10-158 -  
SS-10-160 140 mm -  
5½"

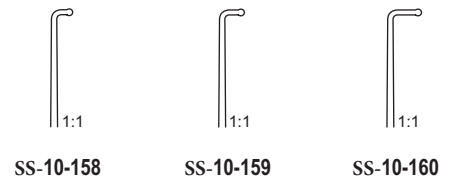

WAGENE  
R  
SS-10-161 140 mm -  
5½"

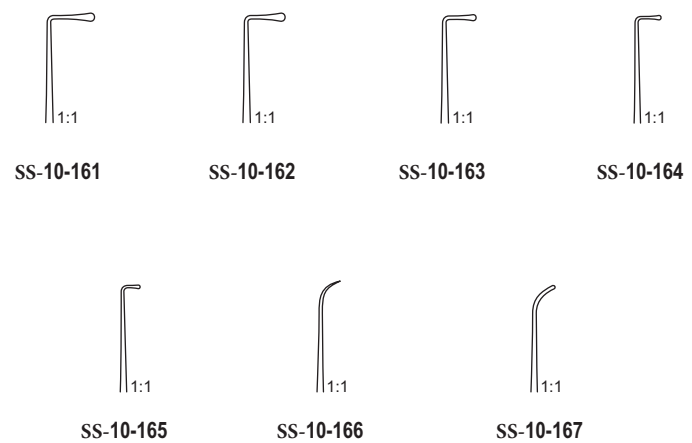

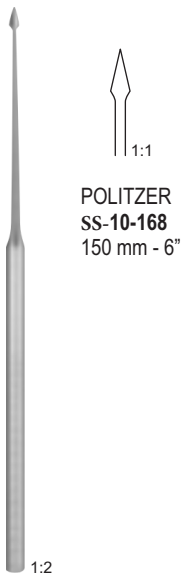

POLITZER  
SS-10-168  
150 mm - 6"

SS-10-168 - SS-10-170



GERZOG  
SS-10-169  
160 mm - 6 1/4"



BUCK  
SS-10-170  
160 mm - 6 1/4"



LUCAE  
SS-10-171  
180 mm - 7"



LUCAE  
SS-10-172  
180 mm - 7"

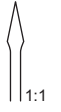

LUCAE  
SS-10-173  
190 mm - 7 1/2"



POLITZER  
SS-10-174  
170 mm - 7 3/4"

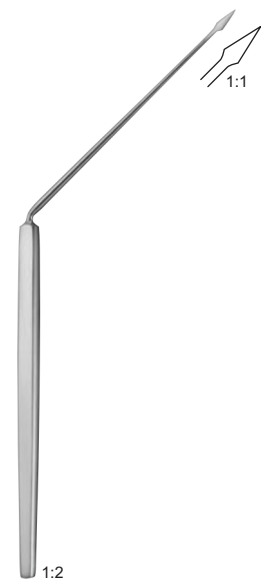

POLITZER  
SS-10-175  
needle vertical  
160 mm - 6 1/4"



SS-10-176  
Needle horizontal  
160 mm - 6 1/4"



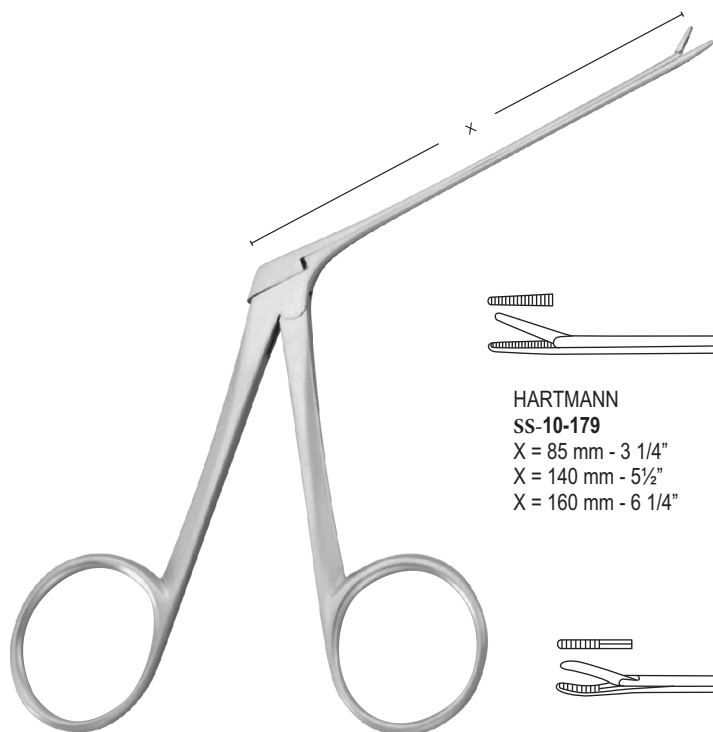

SS-10-177 - SS-10-184

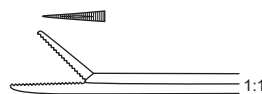

HARTMANN - WULLSTEIN  
SS-10-177  
X = 85 mm - 3 1/4"



HARTMANN - WULLSTEIN  
SS-10-178  
X = 85 mm - 3 1/4" 1 mm ø



HARTMANN  
SS-10-179  
X = 85 mm - 3 1/4"  
X = 140 mm - 5 1/2"  
X = 160 mm - 6 1/4"

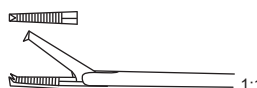

HARTMANN  
SS-10-180  
X = 85 mm - 3 1/4"  
X = 140 mm - 5 1/2"

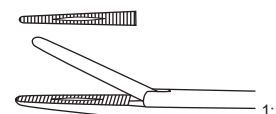

HARTMANN - NOYES  
SS-10-181  
X = 90 mm - 3 1/2"



HARTMANN - WEINGARTNER  
SS-10-182  
X = 85 mm - 3 1/4"



HARTMANN  
SS-10-183  
X = 85 mm - 3 1/4"  
2.0 mm ø  
2.5 mm ø  
3.0 mm ø



STRUEMPEL  
SS-10-184  
X = 85 mm - 3 1/4"

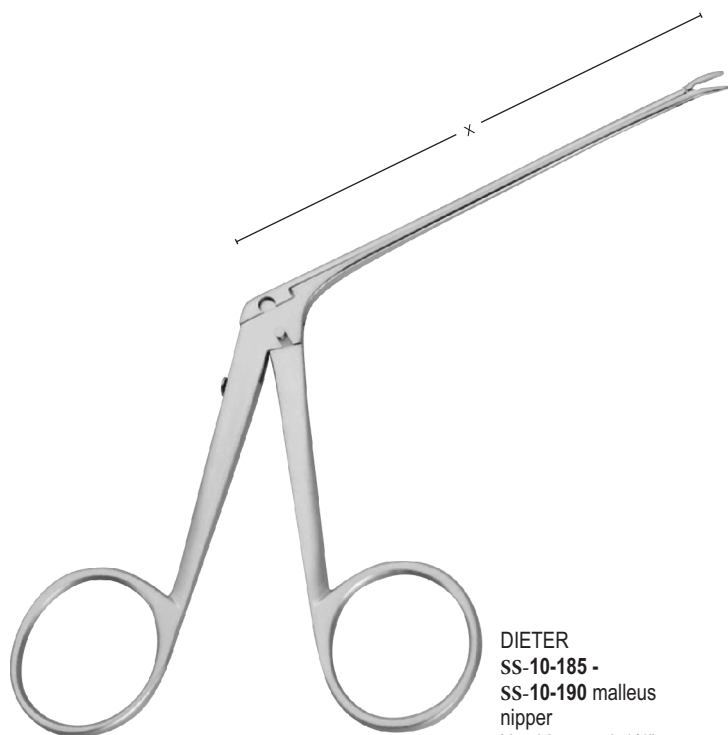

DIETER  
SS-10-185 -  
SS-10-190 malleus  
nipper  
X = 80 mm - 3 1/4"

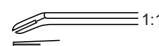

MCGE  
E  
Bending forceps  
3.5 mm X 0.8 mm



FULLER  
SS-10-1  
Introducing forceps  
for teflon prosthesis  
80 mm - 3 1/4"

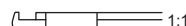

SS-10-187  
Up - cutting



SS-10-188  
Down - cutting



SS-10-189  
Right - cutting

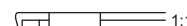

SS-10-190  
Left - cutting



SS-10-191 - SS-10-195

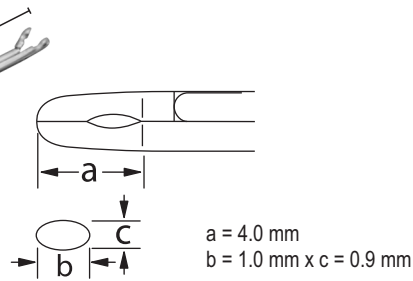

**SS-10-191**  
Straight, oval  
X = 75 mm - 3"



**SS-10-192**  
Curved upwards, oval  
X = 75 mm - 3"



**SS-10-193**  
Curved to left, oval  
X = 75 mm - 3"



**SS-10-194** Curved  
to right, oval X = 75  
mm - 3"



**SS-10-195**  
Curved downwards, oval  
X = 75 mm - 3"

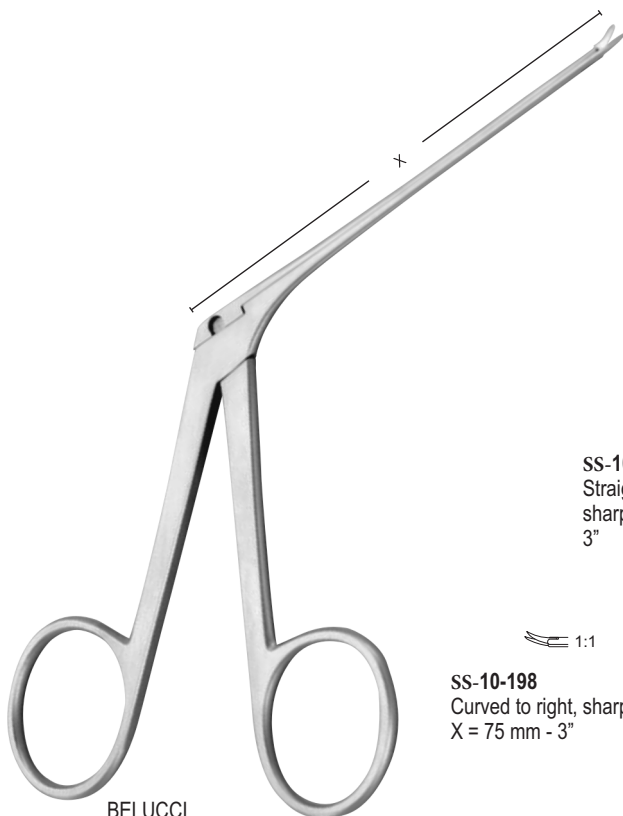

BELUCCI  
SS-10-196 -  
SS-10-200

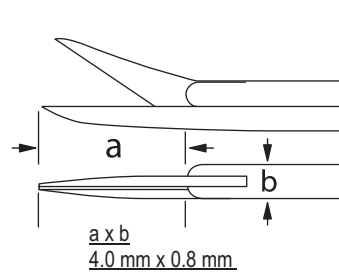

**SS-10-196**  
Straight, sharp/  
sharp X = 75 mm -  
3"



**SS-10-197**  
Curved upwards, blunt/blunt  
X = 75 mm - 3"



**SS-10-198**  
Curved to right, sharp/sharp  
X = 75 mm - 3"



**SS-10-199**  
Curved to left, sharp/sharp  
X = 75 mm - 3"



**SS-10-200** straight,  
sharp/blunt X = 75  
mm - 3"





1:1  
**PLESTER**  
**SS-10-201 -**  
**SS-10-206** 160 mm -  
 6 1/4"



1:1  
**WIRE GUIDE**  
**SS-10-201**

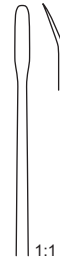

1:1  
**RASPATORY**  
**SS-10-202**



1:1  
**RASPATORY**  
**SS-10-203**  
 1.8 mm

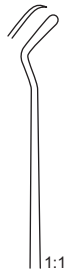

1:1  
**SS-10-204**  
 Dissector, double  
 curved right



1:1  
**SS-10-205**  
 Instrument for placing  
 wire prothesis



1:1  
**SS-10-206**  
 Dissector, double  
 curved left



1:1  
**ROSEN**  
**SS-10-207 -**  
**SS-10-213** 160 mm - 6  
 1/4"

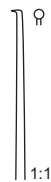

1:1  
**SS-10-207** Circular  
 cutting knife 1.5 mm  
 - 90°



1:1  
**SS-10-208**  
 Tympanum knife  
 45°



1:1  
**SS-10-209**  
 Lancet knife  
 45°



1:1  
**SS-10-210**  
 Lancet knife



1:1  
**RASPATORY**  
**SS-10-211**  
 Zollner  
 1 mm



1:1  
**SS-10-212**  
 Sickle knife,  
 slightly curved



1:1  
**SS-10-213**  
 discision knife,  
 straight curved



SS-10-214 - SS-10-219



**SS-10-214**  
Needle fine, straight, sharp  
160 mm - 6 1/4"



**SS-10-215**  
Needle, slightly curved, sharp  
160 mm - 6 1/4"

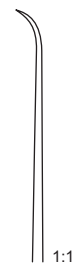

**SS-10-216**  
Needle, strong curved, sharp  
160 mm - 6 1/4"



**SHAMBAUGH**  
**SS-10-217**  
45° Hook, angled  
160 mm - 6 1/4"



**PLESTER**  
**SS-10-218**  
0.4 mm - 90°  
foot plate hook, angled, blunt  
160 mm - 6 1/4"



**PLESTER**  
**SS-10-219**  
0.4 mm - 45°  
Antrum hook, angled, blunt  
160 mm - 6 1/4"



SS-10-220 - SS-10-223



**FISCH**  
**SS-10-220**  
Angled to the right  
155 mm - 6"



**SS-10-221**  
Angled to the left  
155 mm - 6"

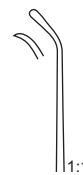

**SS-10-222**  
Angled to the right  
155 mm - 6"



**SS-10-223**  
Angled to the left  
155 mm - 6"



HOUSE  
SS-10-2  
Spoon, strong curved  
spoon, slightly curves  
170 mm - 6 3/4"



SHEA  
SS-10-225  
straight  
160 mm - 6 1/4"  
1.5 mm X 2.5 mm

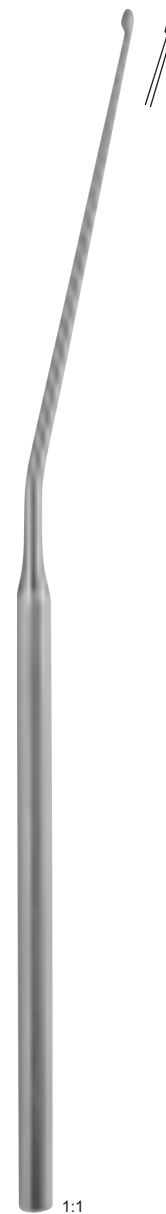

SHEA  
SS-10-226  
curved  
160 mm - 6 1/4"  
1.5 mm X 2.5 mm



1:2

CITELLI  
 SS-10-227 -  
 SS-10-229 X = 60 mm  
 170 mm - 6 3/4"



SS-10-227  
 1.5 mm



SS-10-228  
 2.2 mm



SS-10-229  
 3.0 mm



1:2

SS-10-230 - SS-10-233  
 200 mm - 8"  
 X = 80 mm



SS-10-230  
 3 X 3 mm



SS-10-231  
 4 X 4 mm



SS-10-232  
 5 X 5 mm



SS-10-233  
 6 X 6 mm

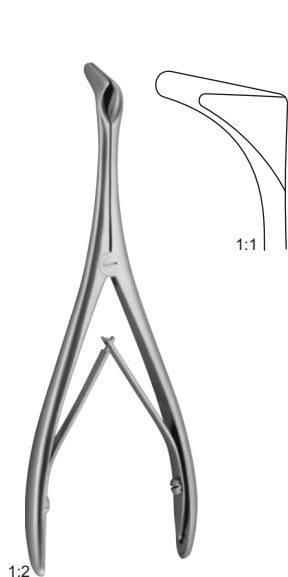

1:2  
TIECK - HALLE  
SS-10-234  
for babies  
135 mm - 5 1/4"



1:2  
BECKMANN  
SS-10-235  
150 mm - 6"



1:2  
MOD. WIEN  
SS-10-236  
145 mm - 5 3/4"

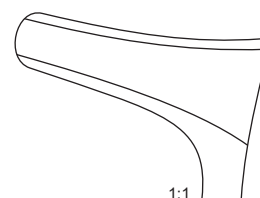
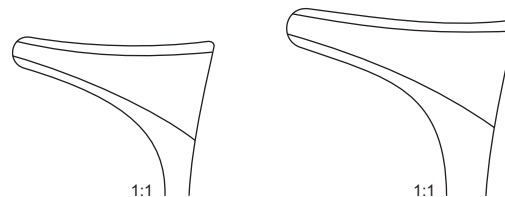

1:2  
SS-10-237 -  
SS-10-240 KILLIAN  
130 mm - 5"

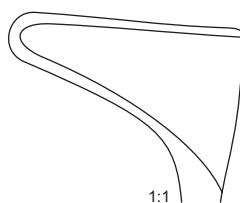

1:1  
SS-10-237  
X = 35 mm

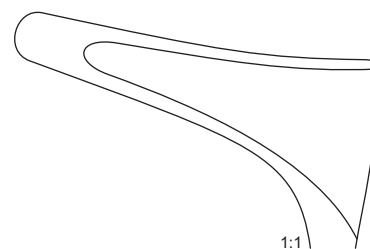

1:1  
SS-10-238  
X = 50 mm

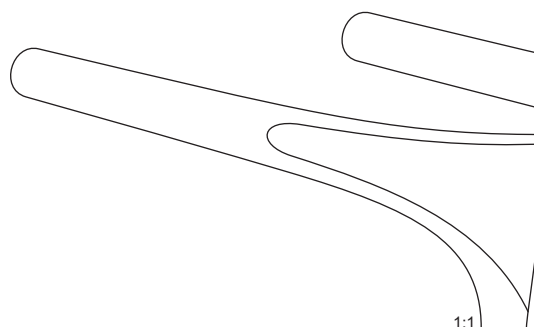

1:1  
SS-10-239  
X = 75 mm

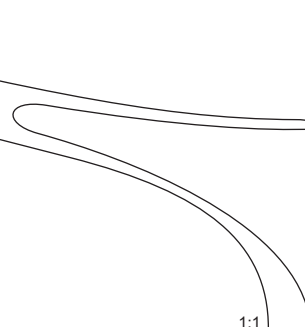

1:1  
SS-10-240  
X = 90 mm



WESTMACOTT  
SS-10-241  
200 mm - 8"

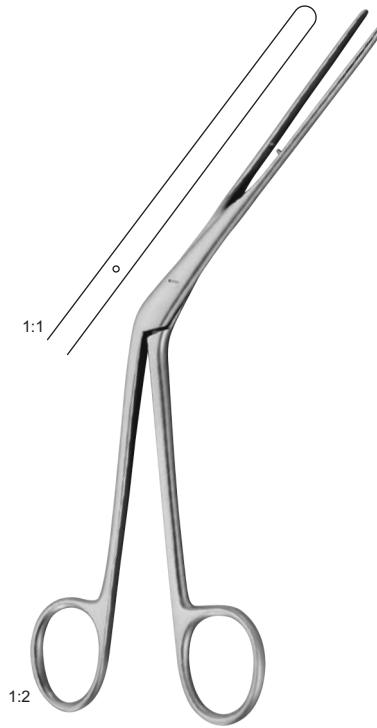

LUBET - BARBON  
SS-10-242  
200 mm - 8"



HARTMANN  
SS-10-243  
160 mm - 6 1/4"  
200 mm - 8"

NASAL DRESSING FORCEPS

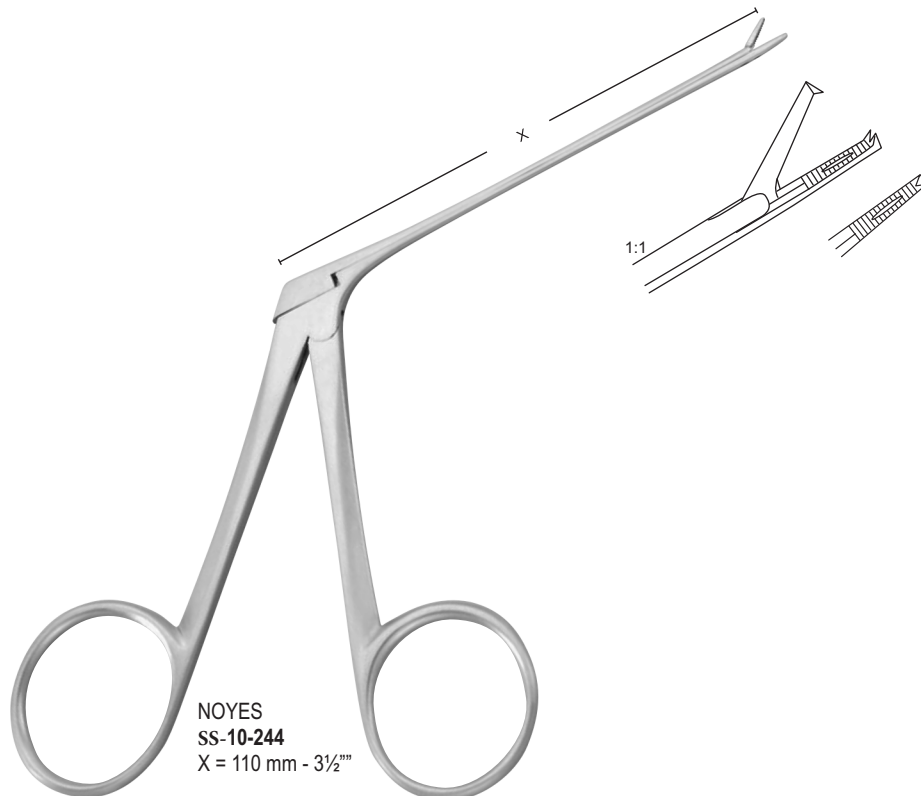

NOYES  
SS-10-244  
X = 110 mm - 3 1/2"

**Fenestrated**

**SS-10-245**  
Fig.1

**SS-10-246**  
Fig.2

**Plain**

**SS-10-247**  
Fig.1

**SS-10-248**  
Fig.2

**TAKAHASHI**  
**SS-10-249**  
X = 120 mm - 4 3/4"

**SS-10-250**  
3.5 mm X 10 mm

**SS-10-251**  
3.5 mm X 10 mm

**SS-10-249 - SS-10-251**

**LUC**  
**SS-10-245 - SS-10-248**  
200 mm - 8"

**SS-10-252**  
X 120 mm - 4 3/4"

**SS-10-253**  
X 120 mm - 4 3/4"

**SS-10-254**  
X 180 mm - 7"

**SS-10-255**  
X 120 mm - 4 3/4"

**SS-10-256**  
X 180 mm - 7"

**WEIL - BLAKESLEY**  
**SS-10-252 -**  
**SS-10-256**

**HARTMANN**

**SS-10-257** **SS-10-258**

**SS-10-259** **SS-10-260** **MYLES**

**SS-10-261**  
Fig.1  
2.0 X 10.0 mm

**SS-10-262**  
Fig.2  
2.5 X 12.0 mm

**SS-10-263**  
Fig.3  
3.0 X 14.0 mm

**SS-10-257 - SS-10-263**  
120 mm - 4 3/4"

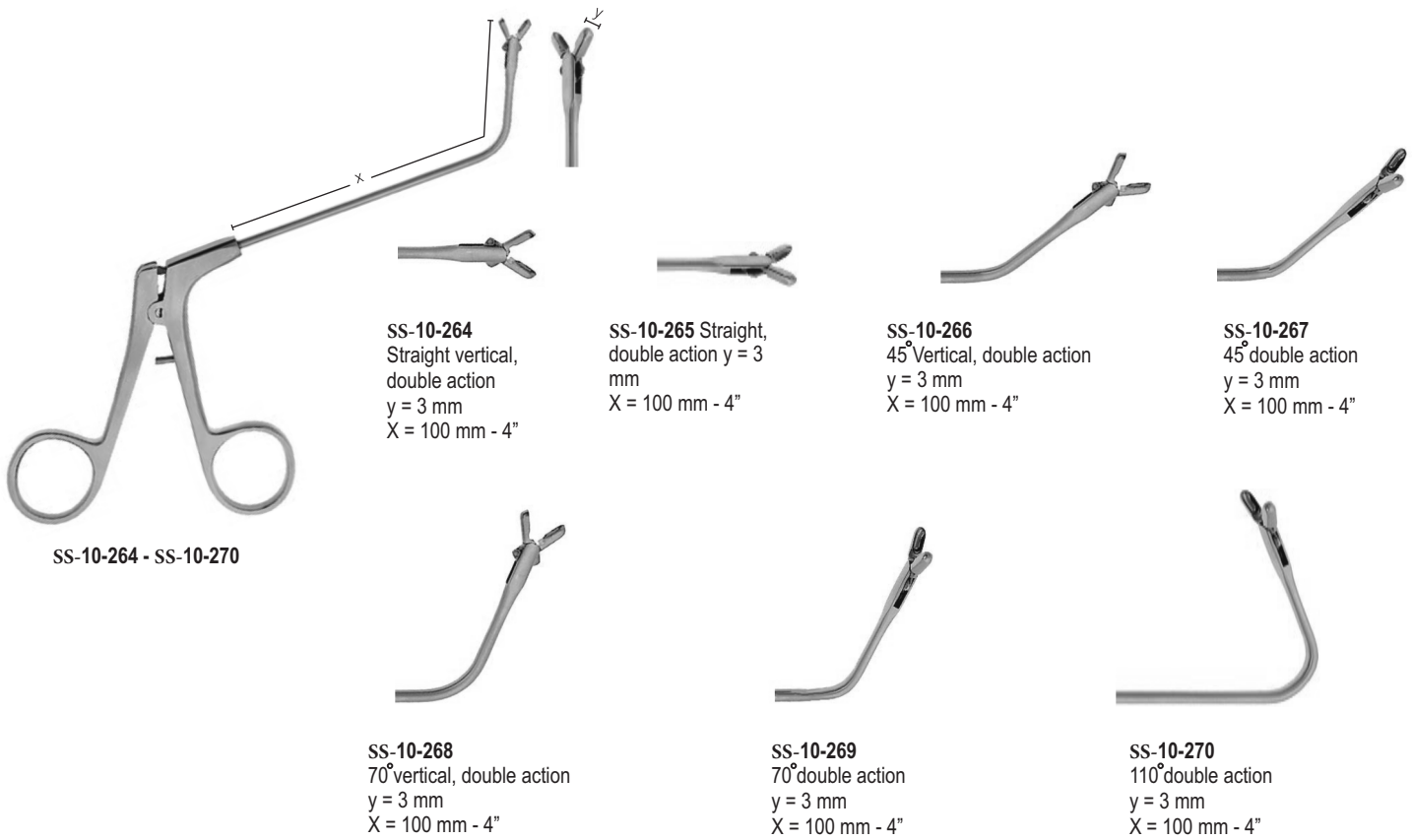

CIRCULAR FORCEPS AND ANTRUM PUNCH

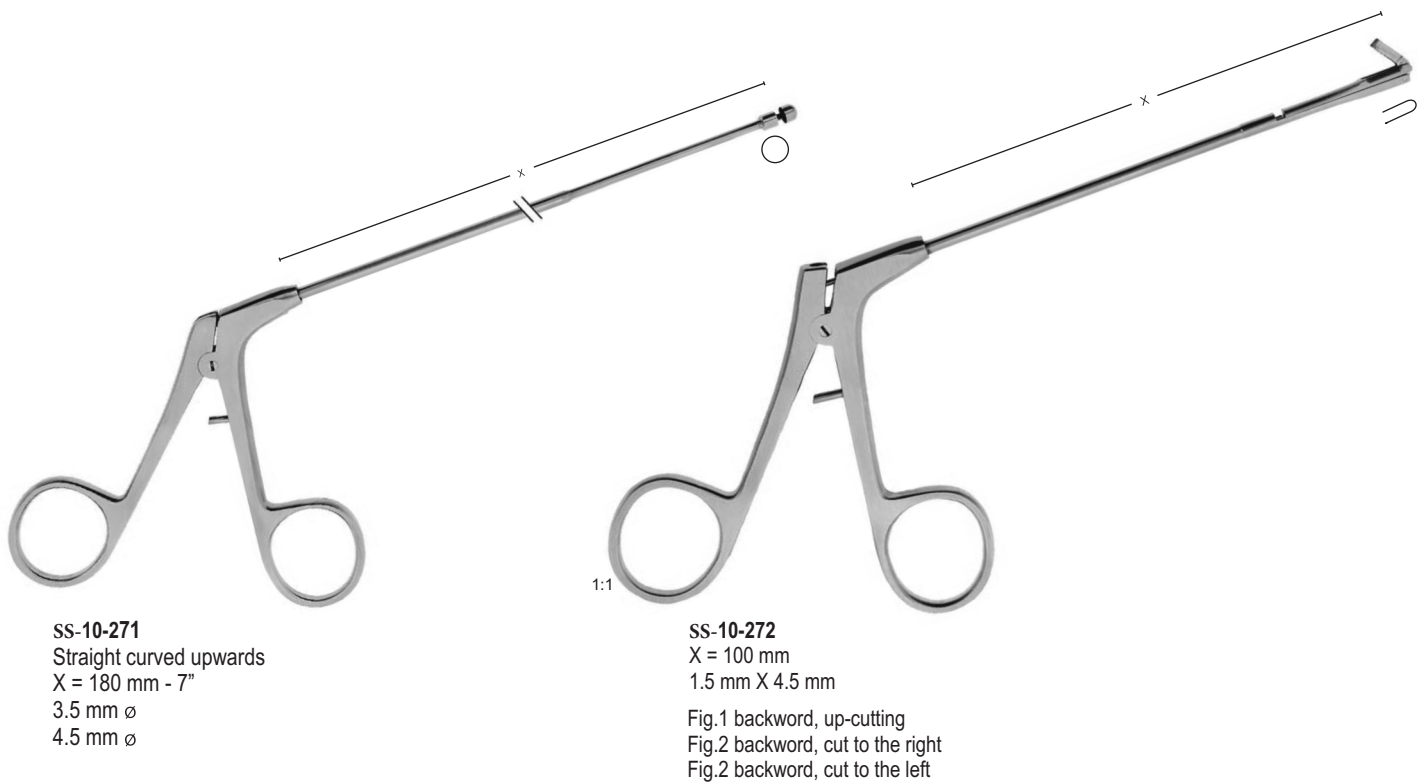





1:2  
FREER  
SS-10-273  
210 mm - 8 1/4"



1:2  
FREER  
SS-10-274  
210 mm - 8 1/4"



1:2  
SICKLE KNIFE  
SS-10-275  
200 mm - 8"



1:2  
BRUNINGS  
SS-10-276  
230 mm - 9"



1:2  
ABRAHAM  
SS-10-277  
220 mm - 8 3/4"



1:2  
FISCHER  
SS-10-278  
230 mm - 9"



1:2  
SHARP  
SS-10-279  
200 mm - 8"



LEMPERT  
SS-10-280  
200 mm - 8"  
X = 6 mm

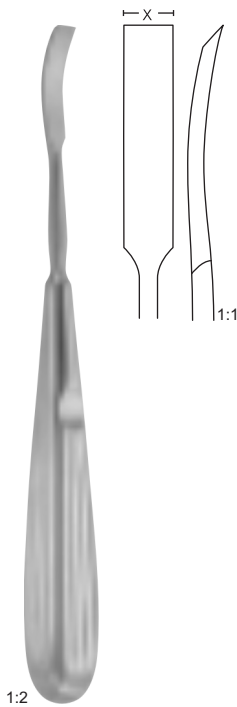

LEMPERT  
SS-10-281  
180 mm - 7"



FREER  
SS-10-282  
160 mm - 6 1/4"  
X = 4 mm

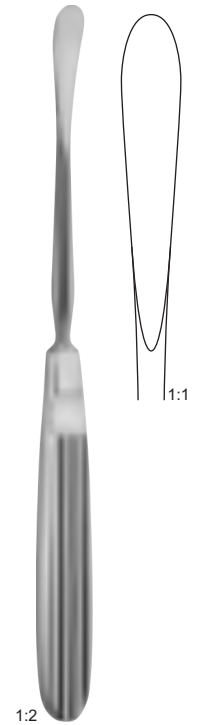

COTTLE  
SS-10-283  
sharp  
190 mm - 7 1/2"  
X = 8 mm

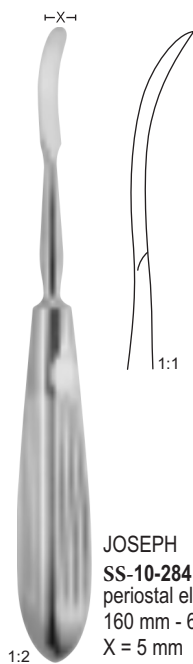

JOSEPH  
SS-10-284  
periosteal elevators  
160 mm - 6 1/4"  
X = 5 mm

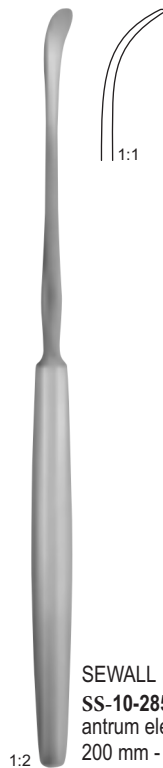

SEWALL  
SS-10-285  
antrum elevators  
200 mm - 8"



HALLE  
SS-10-286  
antrum elevators  
160 mm - 6 1/4"



MASING  
SS-10-287  
200 mm - 8"

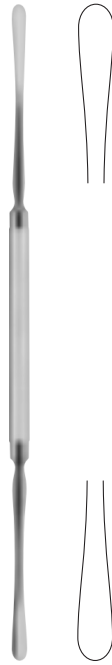

BALLENGER - HAJEK  
SS-10-288  
190 mm - 7 1/4"  
220 mm - 8 3/4"

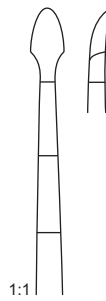

COTTLE  
SS-10-289  
220 mm - 8 3/4"

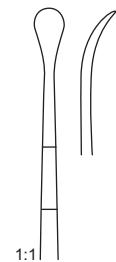
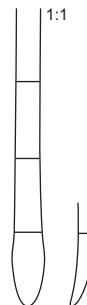

COTTLE  
SS-10-290  
210 mm - 8 1/4"



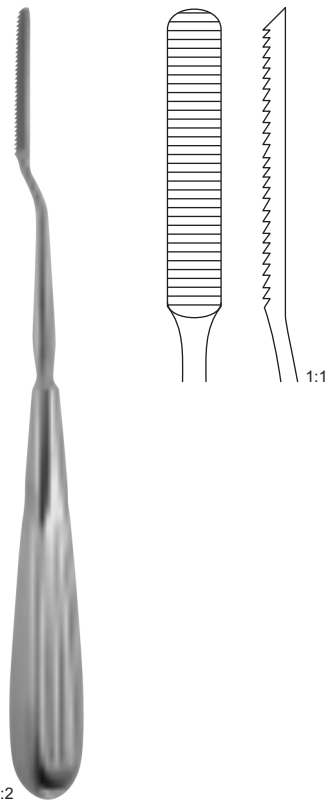

1:2  
COTTLE  
SS-10-291  
210 mm - 8 1/4"

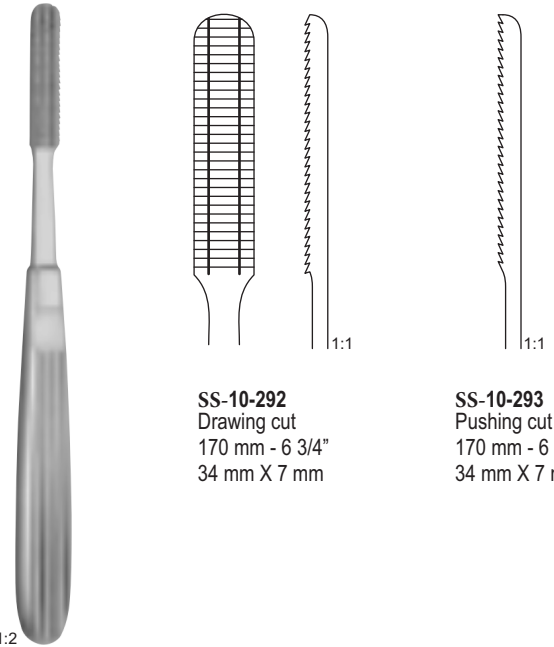

SS-10-292  
Drawing cut  
170 mm - 6 3/4"  
34 mm X 7 mm

SS-10-293  
Pushing cut  
170 mm - 6 3/4"  
34 mm X 7 mm

1:2  
MALTZ  
SS-10-292 -  
SS-10-293

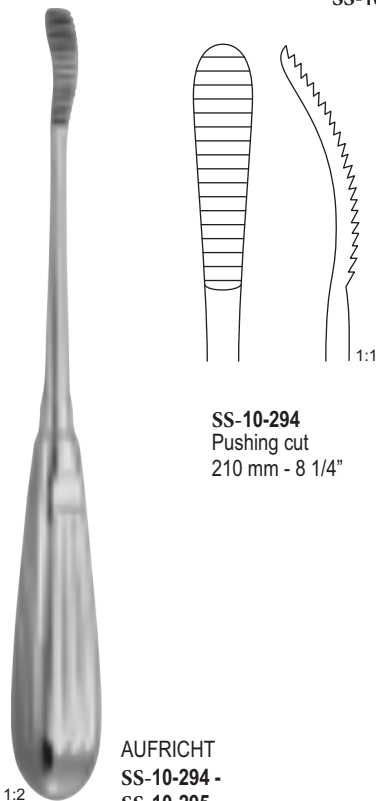

SS-10-294  
Pushing cut  
210 mm - 8 1/4"

SS-10-295  
Drawing cut  
210 mm - 8 1/4"

1:2  
AUFRICHT  
SS-10-294 -  
SS-10-295



SS-10-296 - 205  
200 mm - 8"



FOMON  
Teeth

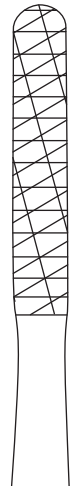

SS-10-296  
Fig.1  
12

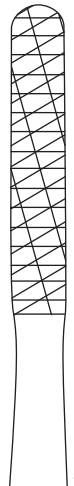

SS-10-297  
Fig.3  
16

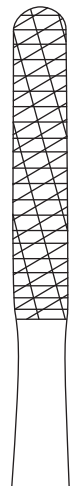

SS-10-298  
Fig.5  
24

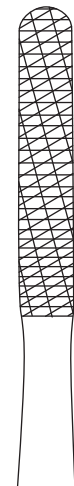

SS-10-299  
Fig.7  
36

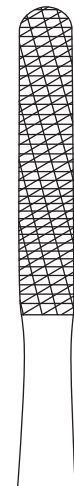

SS-10-300  
Fig.9  
52



FOMON TC  
Teeth

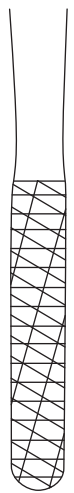

SS-10-301  
Fig.2  
14



SS-10-302  
Fig.4  
20



SS-10-303  
Fig.6  
30



SS-10-304  
Fig.8  
44



SS-10-305  
Fig.10  
62



SS-10-306 - SS-10-308



1:2  
SS-10-306  
Straight

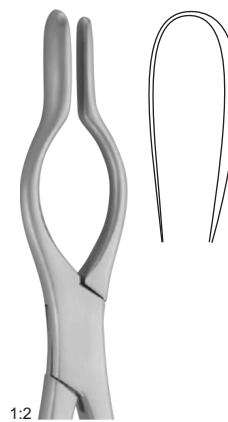

1:2  
SS-10-307  
Left

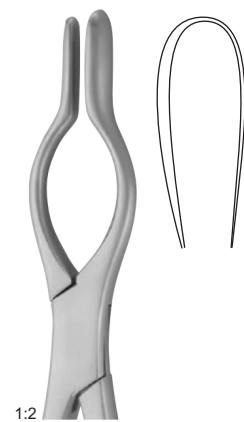

1:2  
SS-10-308  
Right

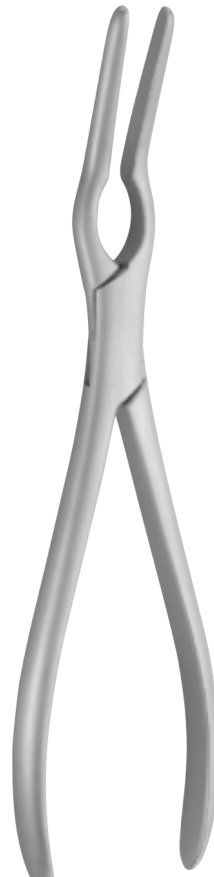

1:2  
ASCH  
SS-10-309  
230 mm - 9"

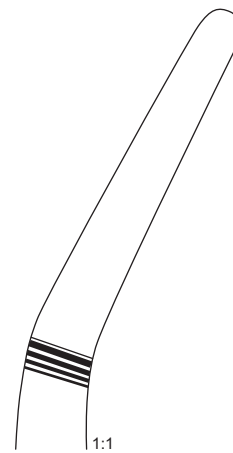

1:1

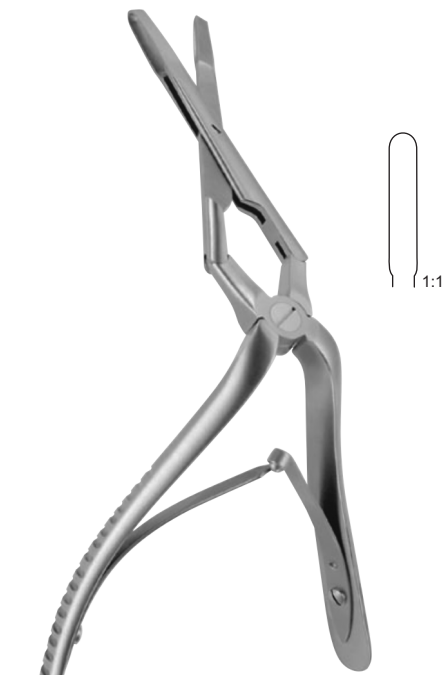

1:2 MIDDLETON - JANSEN  
SS-10-310  
190 mm - 7½"

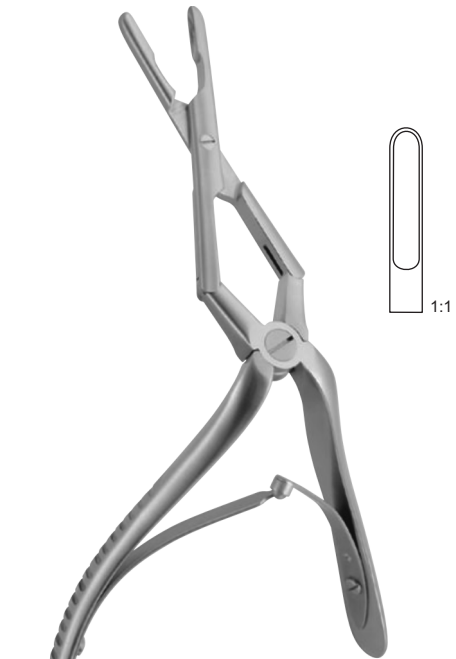

1:2 MIDDLETON - JANSEN  
SS-10-311  
190mm - 7½"

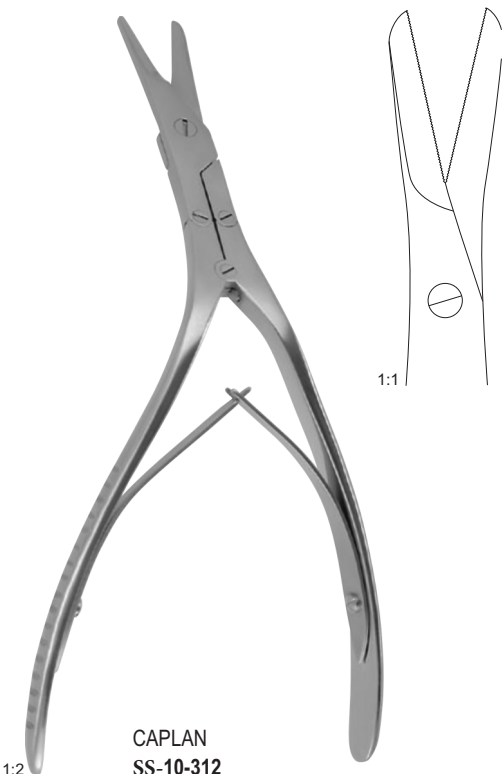

1:2 CAPLAN  
SS-10-312  
toothed  
200 mm - 8"

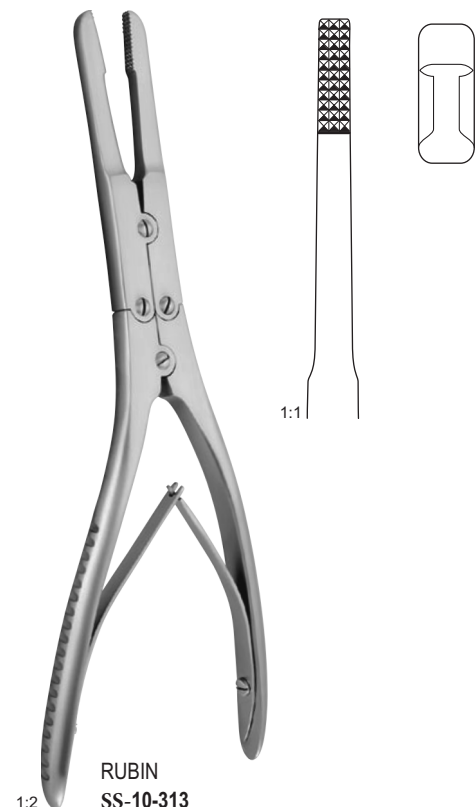

1:2 RUBIN  
SS-10-313  
protection cap  
210 mm - 8 1/4"

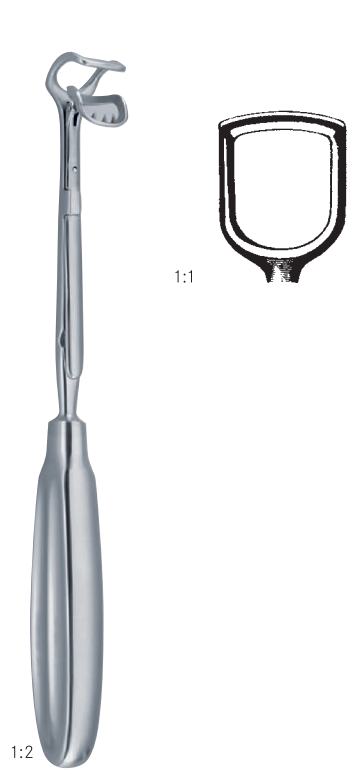

1:2  
ST. CLAIR-THOMSON  
SS-10-314  
210 mm - 8 1/4"

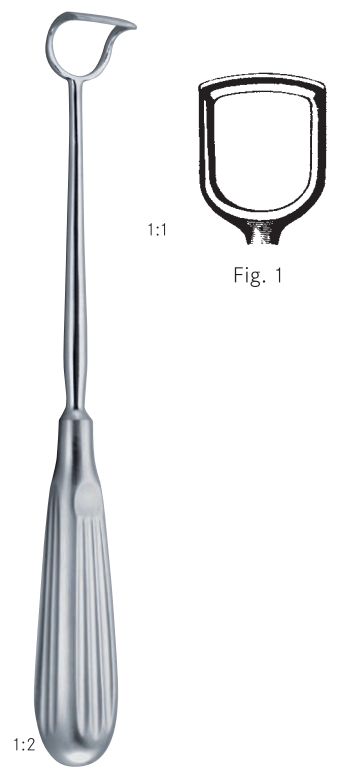

1:2  
BARNHILL  
SS-10-315  
220 mm - 8 3/4"

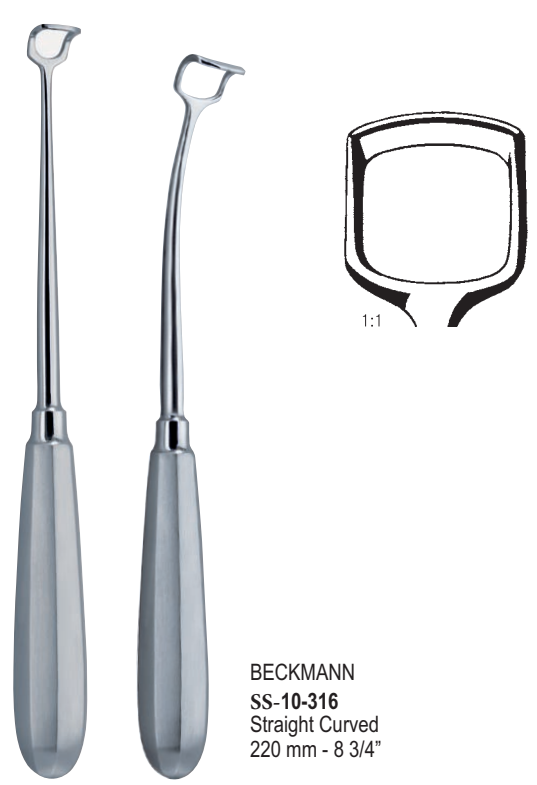

BECKMANN  
SS-10-316  
Straight Curved  
220 mm - 8 3/4"

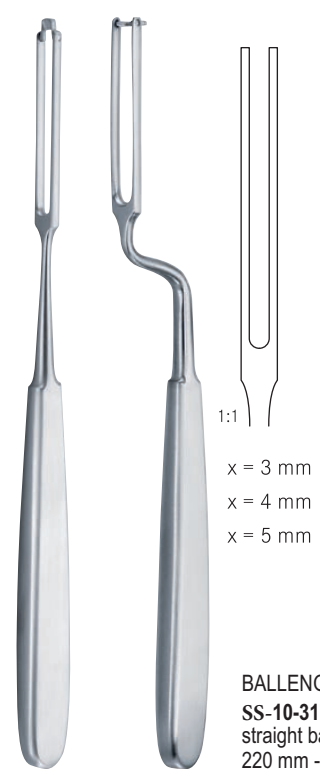

BALLENGER  
SS-10-317  
straight bayonet  
220 mm - 8"





1:2

MOLT  
SS-10-318  
for children  
110 mm - 4 1/4"



1:2

MOLT  
SS-10-319  
for adults  
140 mm - 5 1/2"



1:2

DENHART  
SS-10-320  
120 mm - 4 3/4"



1:2

FERGUSON -  
ACKLAND SS-10-321  
145 mm - 5 3/4"



ROSER - KÖNIG  
SS-10-322  
160 mm - 6 1/4"  
190 mm - 7 1/2"

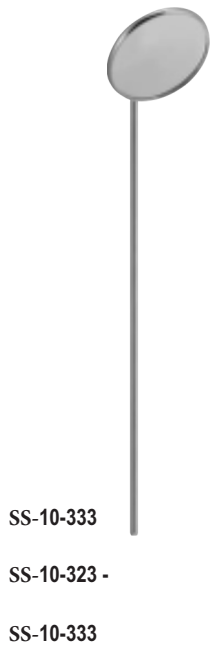

SS-10-33	Fig. 00	8 mm	∅
SS-10-324	Fig. 0	10 mm	∅
SS-10-325	Fig. 1	12 mm	∅
SS-10-326	Fig. 2	14 mm	∅
SS-10-327	Fig. 3	16 mm	∅
SS-10-328	Fig. 4	18 mm	∅
SS-10-329	Fig. 5	20 mm	∅
SS-10-330	Fig. 6	22 mm	∅
SS-10-331	Fig. 7	24 mm	∅
SS-10-332	Fig. 8	26 mm	∅
SS-10-333	Fig. 9	28 mm	∅
SS-10-333	Fig. 10	30 mm	∅



SS-10-335	Fig. 00	8 mm	∅
SS-10-336	Fig. 0	10 mm	∅
SS-10-337	Fig. 1	12 mm	∅
SS-10-338	Fig. 2	14 mm	∅
SS-10-339	Fig. 3	16 mm	∅
SS-10-340	Fig. 4	18 mm	∅
SS-10-341	Fig. 5	20 mm	∅
SS-10-342	Fig. 6	22 mm	∅
SS-10-343	Fig. 7	24 mm	∅
SS-10-344	Fig. 8	26 mm	∅
SS-10-345	Fig. 9	28 mm	∅
SS-10-346	Fig. 10	30 mm	∅

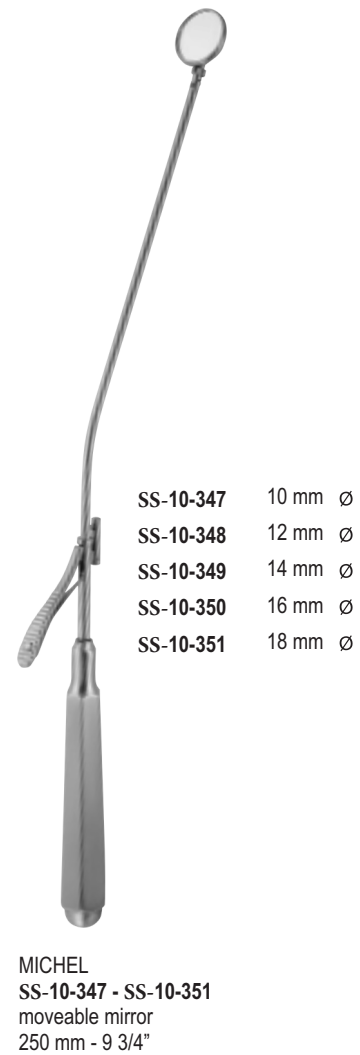

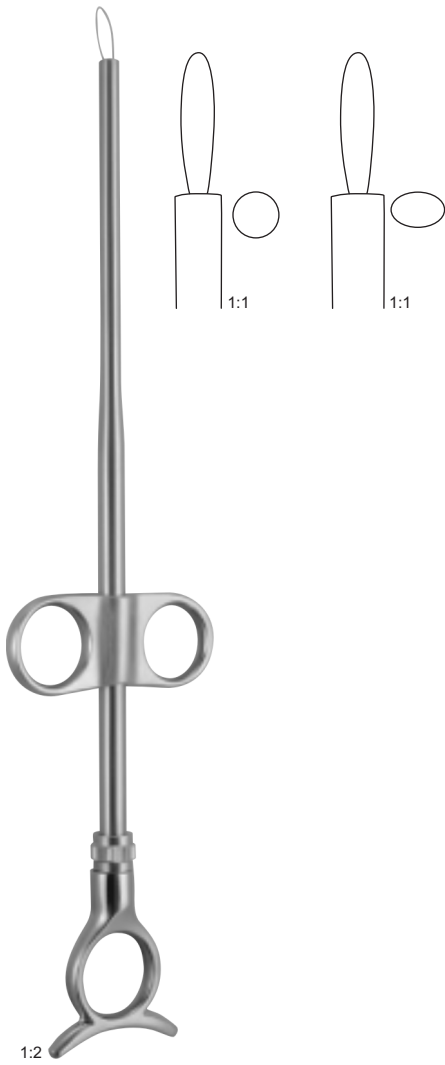

EVES  
**SS-10-352**  
 280 mm - 11"



EVES  
**SS-10-353**  
 280 mm - 11"



BRUENINGS  
**SS-10-354**  
 280 mm - 11"



**SS-10-355**  
 10 mm - 33 ft.  
 0.3 mm Ø  
 0.4 mm Ø

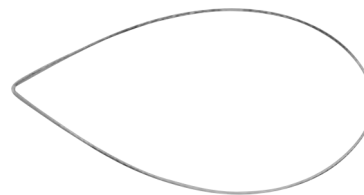

**SS-10-356** Package of  
 100 pieces 40 mm 50  
 mm



1:2  
**COLVER**  
**SS-10-357**  
 straight curved  
 190 mm - 7½"



1:2  
**WHITE**  
**SS-10-358**  
 180 mm - 7"  
 230 mm - 9"

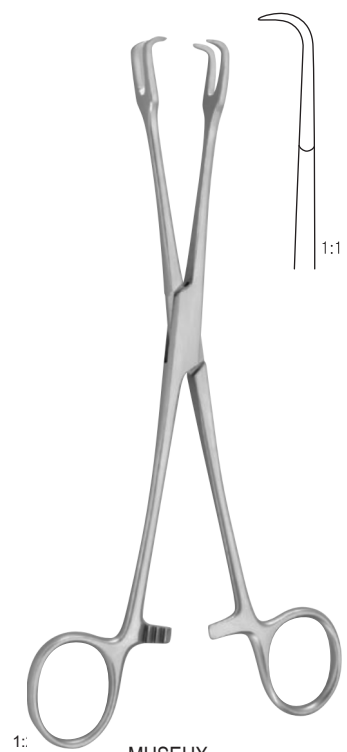

1:1  
**MUSEUX**  
**SS-10-3**  
 tonsil holding forceps  
 200 mm - 8"

TRACHEA DILATOR



1:2  
**JACKSON**  
**SS-10-360**  
 laryngeal forceps  
 220 mm - 8½"

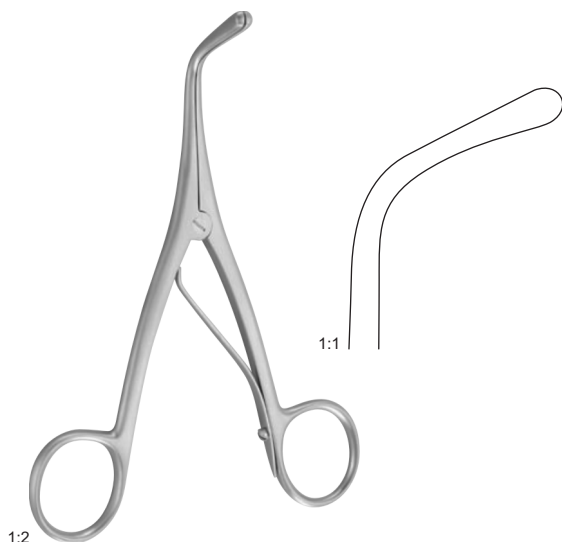

1:2  
**TROUSSEAU**  
**SS-10-361**  
 140 mm - 5½"

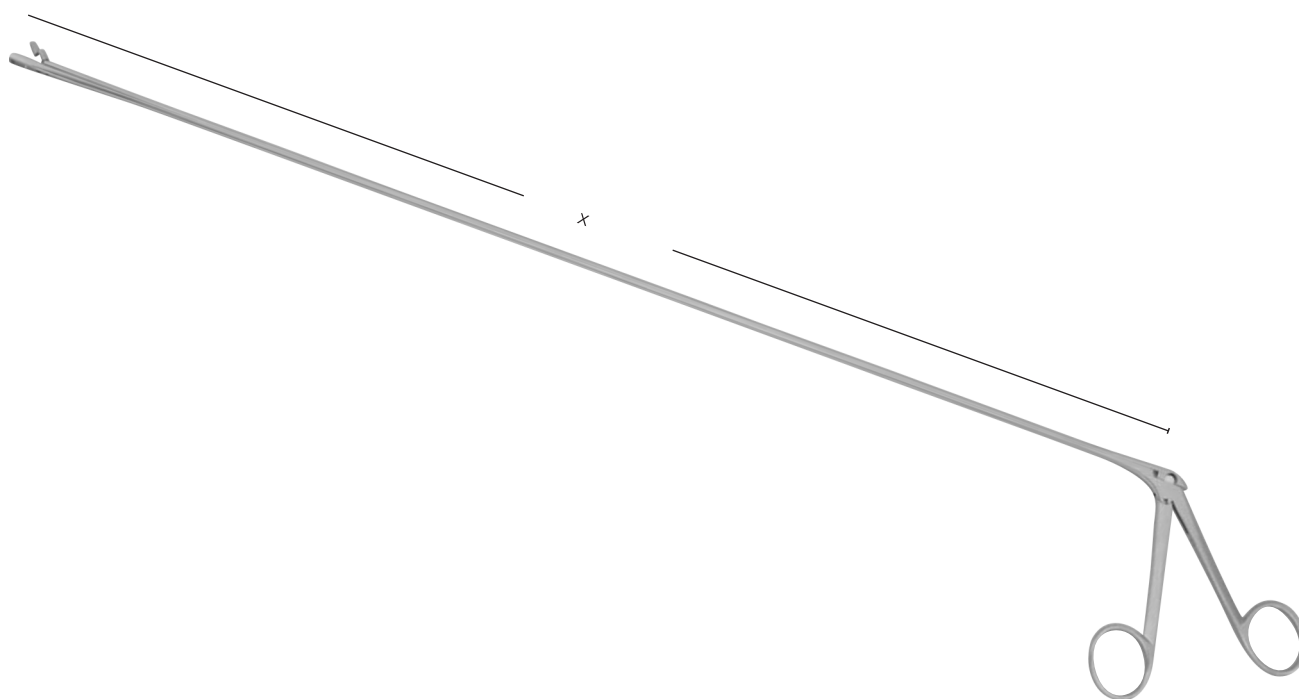

SS-10-362



SS-10-363



SS-10-364



SS-10-365

CHEVALIER - JACKSON  
 SS-10-32 - SS-10-368 X  
 = 300 mm - 12"  
 X = 400 mm - 16"  
 X = 500 mm - 20"  
 X = 600 mm - 23½"



SS-10-366



SS-10-367



SS-10-368

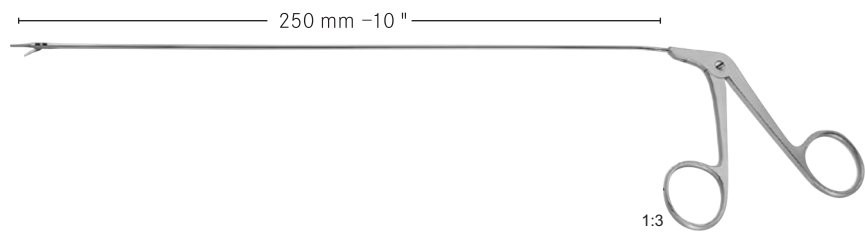

SS-10-39 -SS-10-385

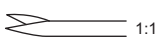

SS-10-369  
Straight



SS-10-370  
Straight horizontal



SS-10-371 Angled  
up horizontal

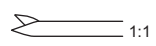

SS-10-372  
Curved right

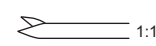

SS-10-373  
Curved left

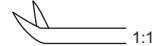

SS-10-374  
Angled up



SS-10-375  
Straight, serrated



SS-10-376  
Straight horizontal



SS-10-377 Angled  
up horizontal



SS-10-378  
Curved right



SS-10-379  
Curved left



SS-10-380  
Straight



SS-10-381  
Angled up  
02.5 mm

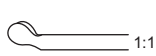

SS-10-382 Angled  
up horizontal



SS-10-383  
Curved right



SS-10-384  
Curved left



SS-10-385  
Oval  
03.5 mm



½

DAVIS-BOYLE  
SS-10-386 - SS-10-388  
complete, consisting of frame  
and 5 tongue depressors no. 1-5

SS-10-386  
Frame for Mouth Gag

SS-10-387  
14.5 cm  
Frame for Mouth Gag with joint

SS-10-388  
14.5 cm  
Silicone inlay



½

Fig. 1  
SS-10-389 -  
SS-10-392 110 X 28  
mm



Fig. 2  
SS-10-389  
95 X 27 mm



Fig. 3  
SS-10-390  
80 X 27 mm



Fig. 4  
SS-10-391  
65 X 26 mm



Fig. 5  
SS-10-3  
without suction tube  
30 X 20 mm



NEUKAM  
SS-10-393 - 297  
complete, with frame and  
3 tongue depressors

NEUKAM  
SS-10-393  
Frame for Mouth Gag, only



KILNER-DOUGHTY  
SS-10-38 - SS-10-304  
complete, with frame, 3 tongue depressors,  
2 toothplates and 1 palate plate



SS-10-399  
Palate plate

KILNER-DOUGHTY  
SS-10-400  
14.5 cm  
Frame for Mouth Gag

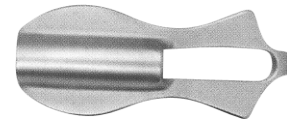

SS-10-394  
Tongue Depressor

fenestrated blade for suction



1/2

Fig. 1  
SS-10-395

Fig. 2  
SS-10-396

Fig. 3  
SS-10-397



KILNER-DOUGHTY  
SS-10-401  
Tongue Depressor

fenestrated blade for suction

1/2

Fig. 1  
SS-10-402  
68 X 30 mm

Fig. 2  
SS-10-403  
77 X 34 mm

Fig. 3  
SS-10-404  
82 X 39 mm



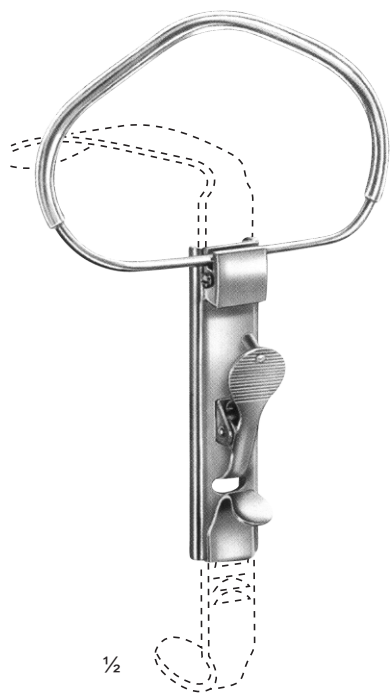

MCLVOR  
SS-10-405 - 309  
complete, with 3 tongue depressors

MCLVOR  
SS-10-405  
Frame for Mouth Gag

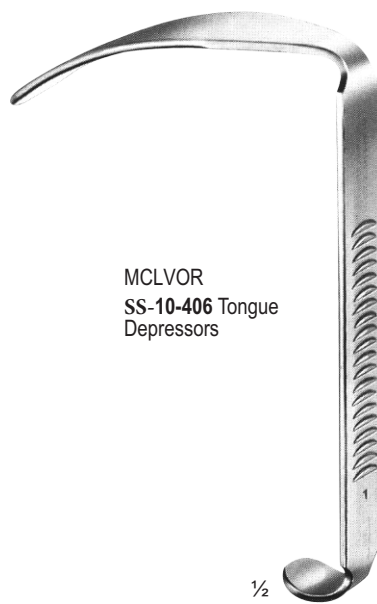

MCLVOR  
SS-10-406 Tongue  
Depressors

Fig. 1  
SS-10-407  
100 X 25 mm

Fig. 2  
SS-10-408  
85 X 25 mm

Fig. 3  
SS-10-409  
75 X 25 mm

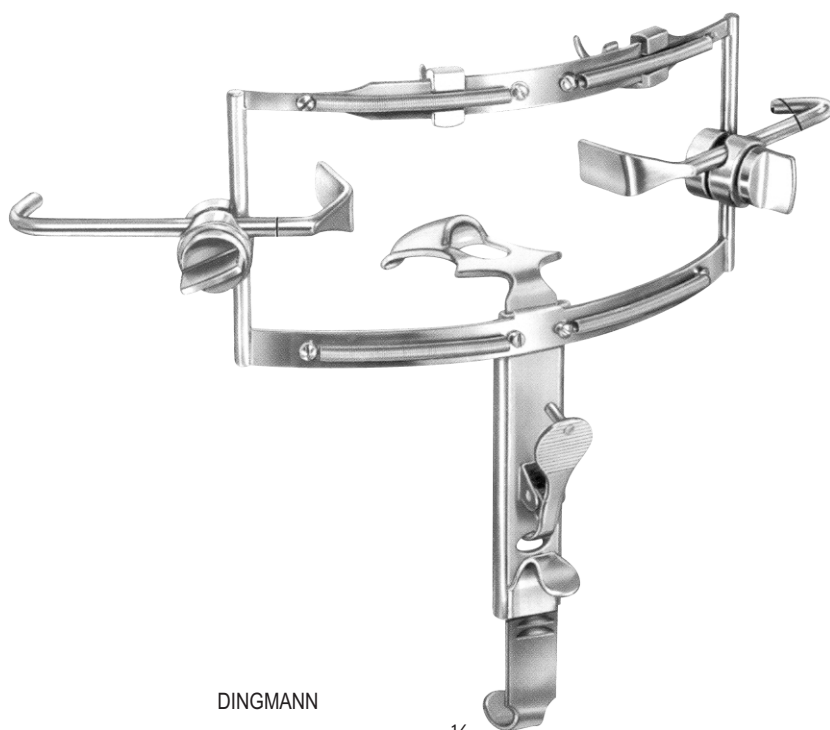

DINGMANN  
RI 10-410 - AE-10-413 1/2 complete,  
with frame, 3 tongue depressors,  
and 2 adjustable lateral blades

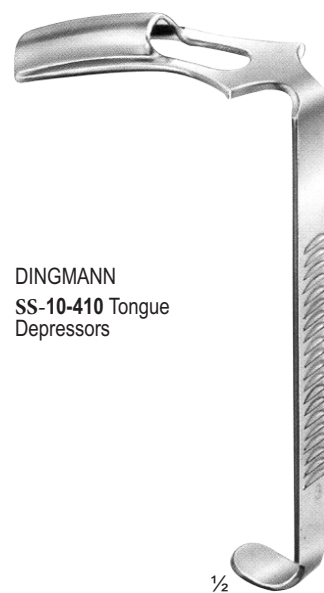

DINGMANN  
SS-10-410 Tongue  
Depressors

Fig. 1  
SS-10-411  
62 X 26 mm

Fig. 2  
SS-10-412  
65 X 30 mm

Fig. 3  
SS-10-413  
78 X 32 mm



**SS-10-414**  
Fig.1  
20 mm X 70 mm



**SS-10-415**  
Fig.2  
30 mm X 80 mm



**SS-10-416**  
Fig.3  
33 mm X 95 mm



**SS-10-417**  
Handle

NEGUS  
SS-10-414 -  
SS-10-417 complete  
handle

TONSIL INSTRUMENTS

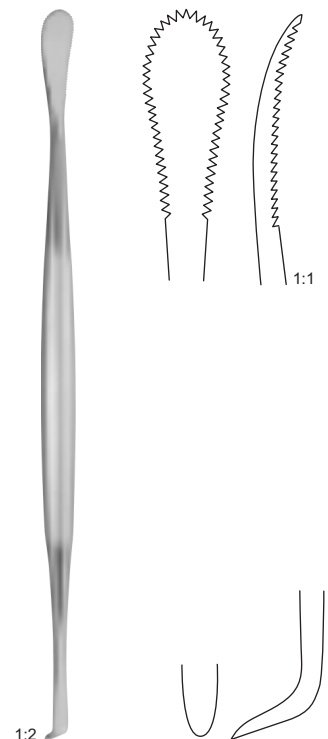

**HENKE**  
**SS-10-418**  
tonsil dissector  
230 mm - 9"

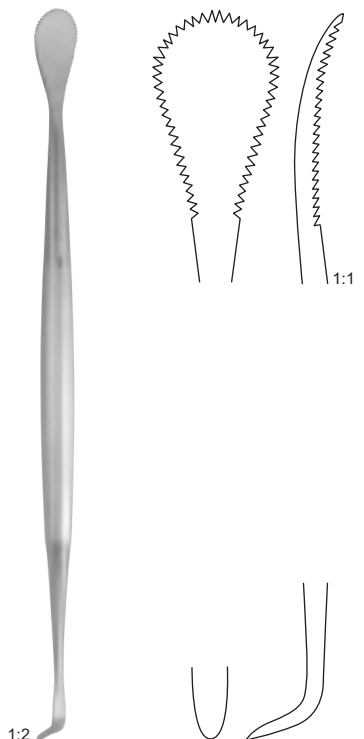

**HENKE**  
**SS-10-419**  
tonsil dissector  
230 mm - 9"

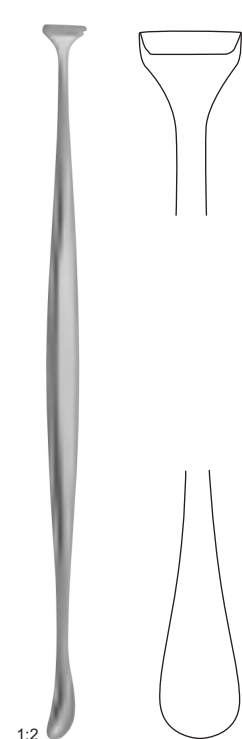

**HURD**  
**SS-10-420**  
tonsil dissector  
225 mm - 8 3/4"



JENNINGS  
 SS-10-421 - SS-10-424  
 SS-10-421 10.5 cm  
 SS-10-422 12.5 cm  
 SS-10-423 14.5 cm  
 SS-10-424 16.5 cm

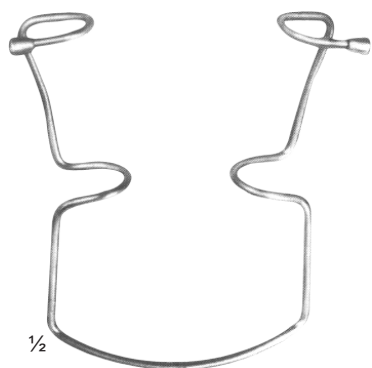

ORINGER  
 SS-10-425 - SS-10-427  
 9.5 cm  
 self retaining, for children

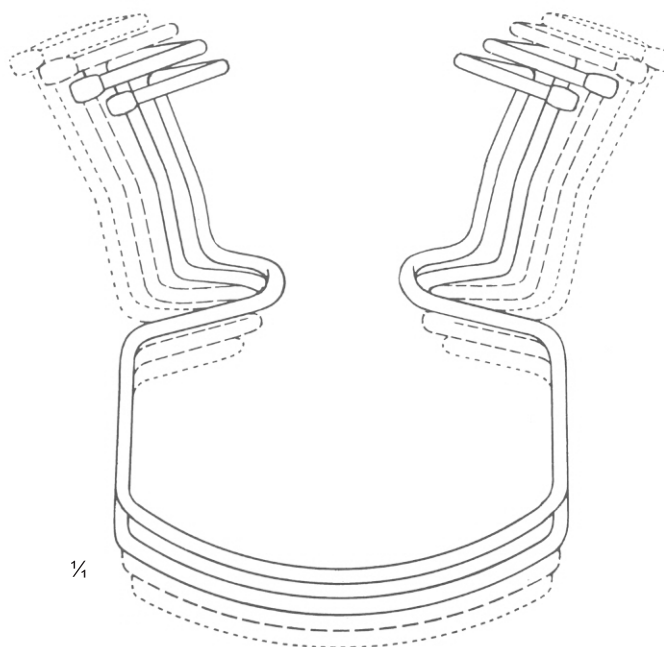
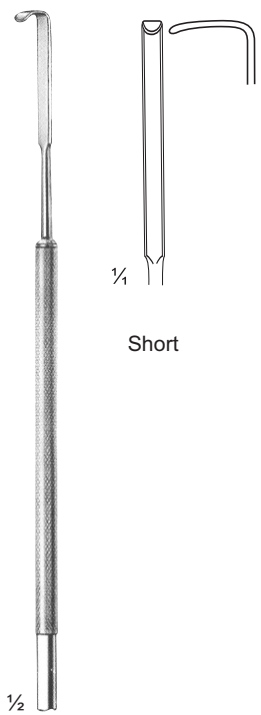

Fig. 1  
 SS-10-425  
 10 cm

Fig. 2  
 SS-10-426  
 10.5 cm

Fig. 3  
 SS-10-427  
 11 cm



Short

SALYER  
**SS-10-428**  
 185 mm  
 Cleft Palate  
 Hooklets

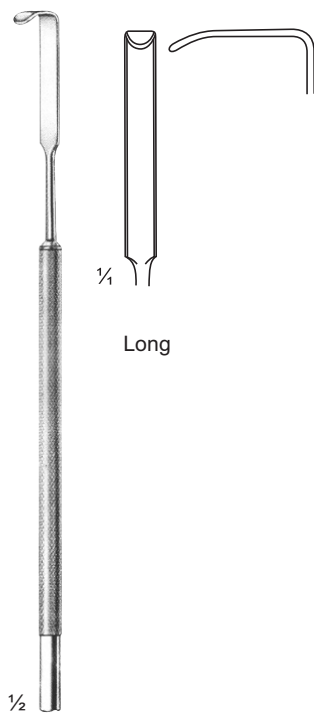

Long

SALYER  
**SS-10-429**  
 185 mm  
 Cleft Palate  
 Hooklet

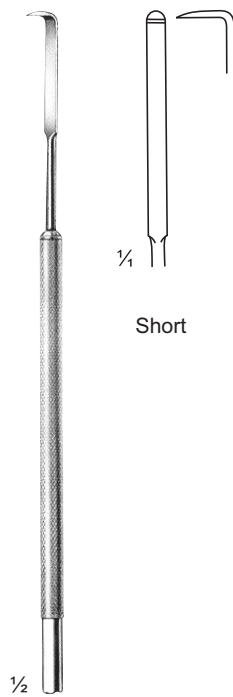

Short

SALYER  
**SS-10-430**  
 180 mm  
 Cleft Palate  
 Dissector

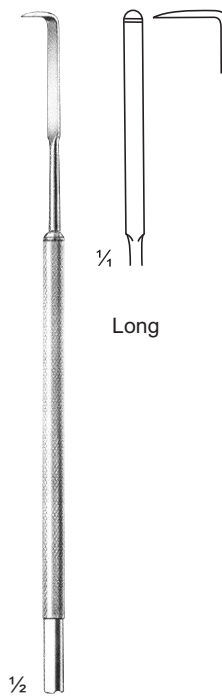

Long

SALYER  
**SS-10-431**  
 180 mm  
 Cleft Palate  
 Dissector

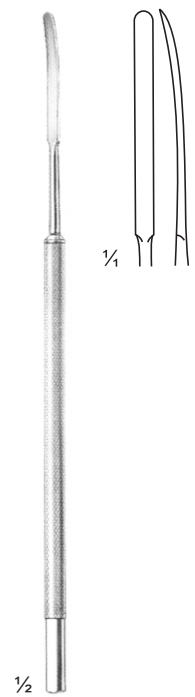

SALYER  
**SS-10-432**  
 180 mm  
 Cleft Palate  
 Instruments

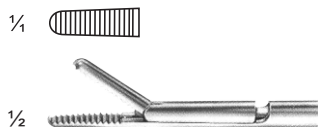

FRAENKEL  
SS-10-433  
for interchangeable tubes

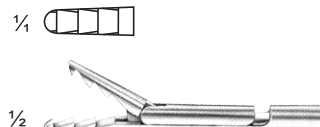

SEIFFERT  
SS-10-434  
for interchangeable tubes

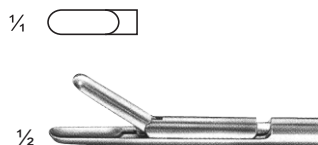

FRAENKEL  
SS-10-435  
for interchangeable tubes

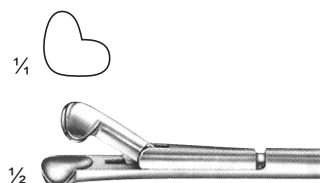

SCHEINMANN  
SS-10-436  
for interchangeable tubes

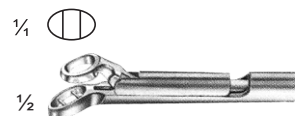

SCHEINMANN  
SS-10-437  
for interchangeable tubes



BRÜNINGS  
SS-10-438 - SS-10-439  
for interchangeable tubes

Fig. 2  
SS-10-438

Fig. 3  
SS-10-439

Fig. 2  
SS-10-440

Fig. 3  
SS-10-441



BRÜNINGS  
SS-10-440 - SS-10-441  
for interchangeable tubes



LANGE  
SS-10-442  
for interchangeable tubes

Fig. 1  
SS-10-442



Fig. 1  
SS-10-443



Fig. 2  
SS-10-444



KRAUSE  
SS-10-443 - SS-10-444  
for interchangeable tubes

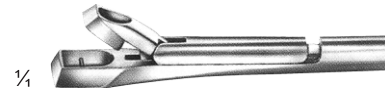

KRAUSE  
SS-10-445  
for interchangeable tubes



Fig. 1  
SS-10-446



Fig. 2  
SS-10-447



Fig. 3  
SS-10-448



Fig. 4  
SS-10-449



CORDES  
SS-10-446 - SS-10-449  
for interchangeable tubes

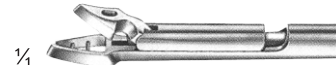

SCHUMACHER  
SS-10-450  
for interchangeable tubes



Fig. 1  
SS-10-451



Fig. 2  
SS-10-452



CORDES  
SS-10-451 - SS-10-452  
for interchangeable tubes



CORDES  
SS-10-453  
for interchangeable tubes



ROSENBERG  
SS-10-454  
for interchangeable tubes

WE HAVE ALL RANGE OF INSTRUMENTS



## CONTACT INFO



+92-340 0473111



swisons.ind@gmail.com



www.swisons.com



Small Industrial Estate, Sialkot 51310 Pakistan

Get your high quality Instruments