



SWISONS

SURGICALS

- Elevators
- Bone levers
- Raspotries
- Bone Files
- Bone Curretes



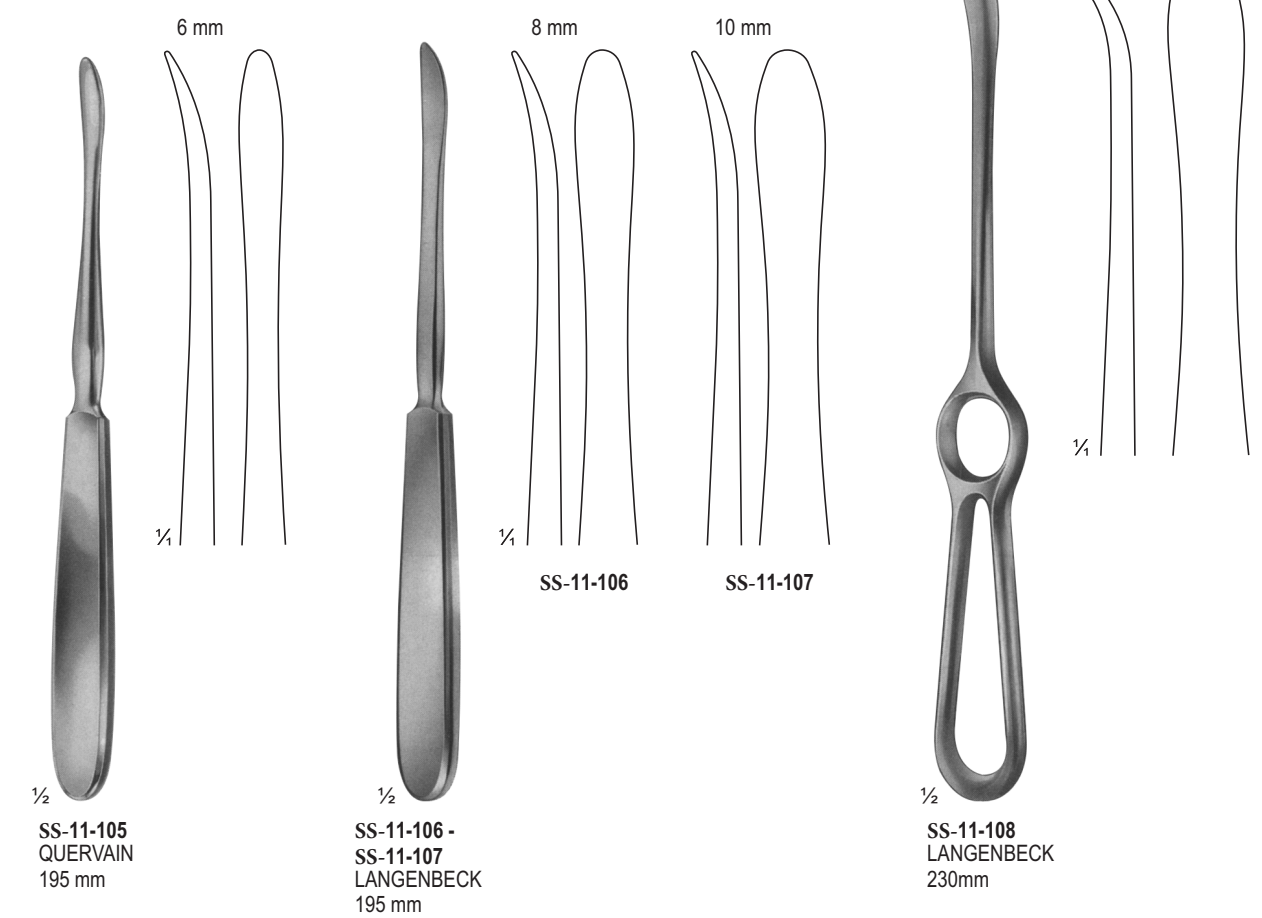
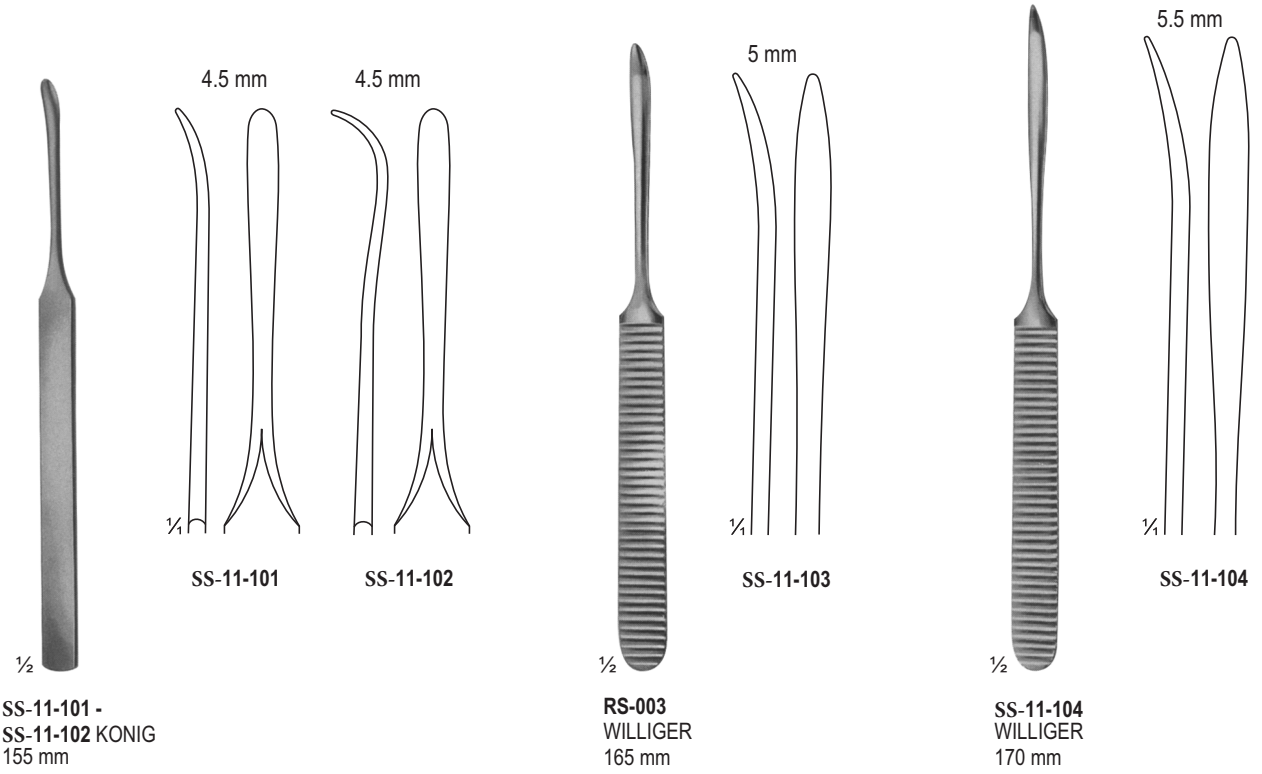



SS-11-109
LANE
TRETOWAN
215mm

SS-11-110
LANE
255mm

SS-11-111 LANGE-
HOHMANN 250mm

SS-11-112 -
SS-11-113 LANGE-
HOHMANN RS-012
265mm RS-013
280mm

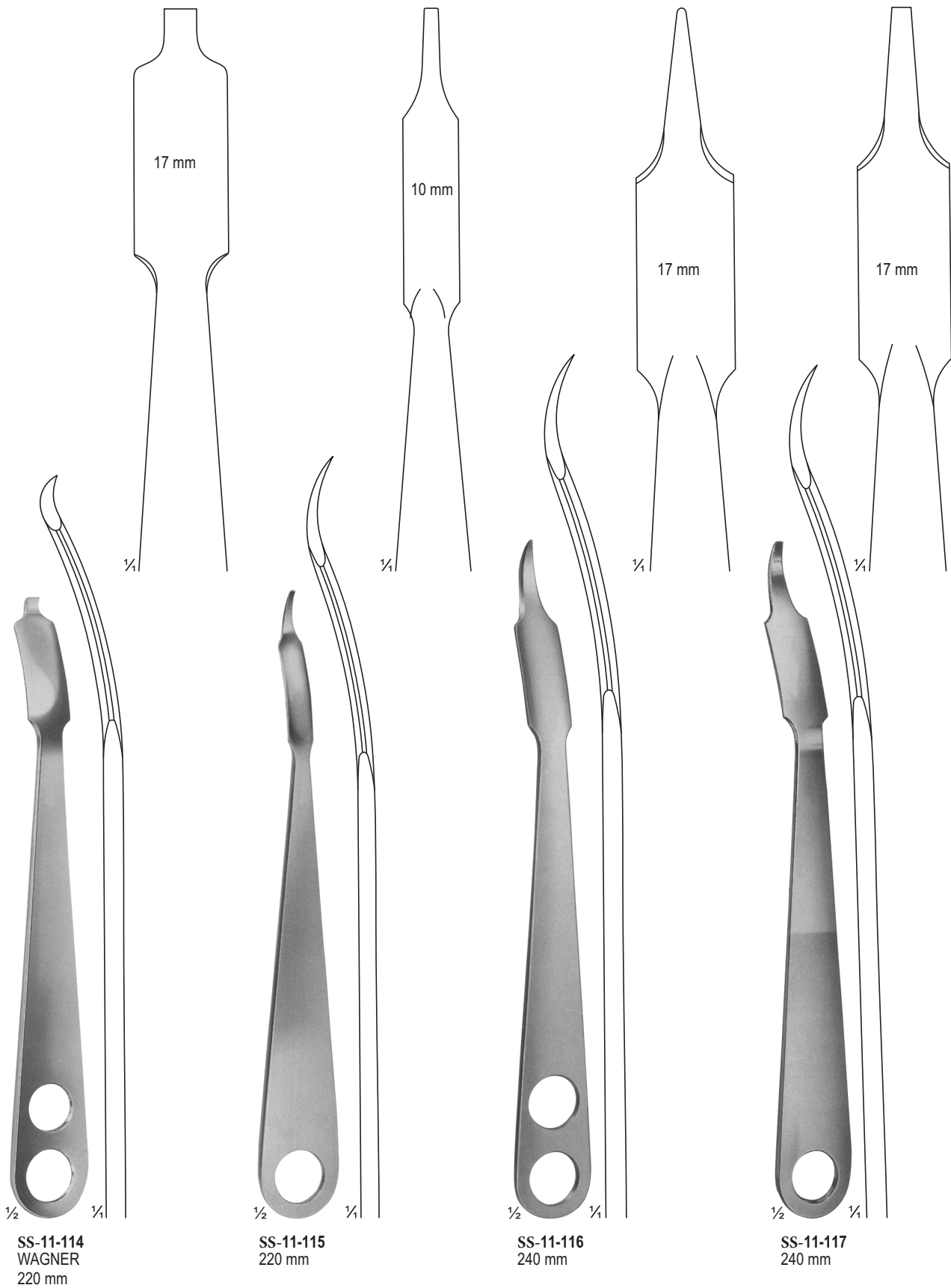

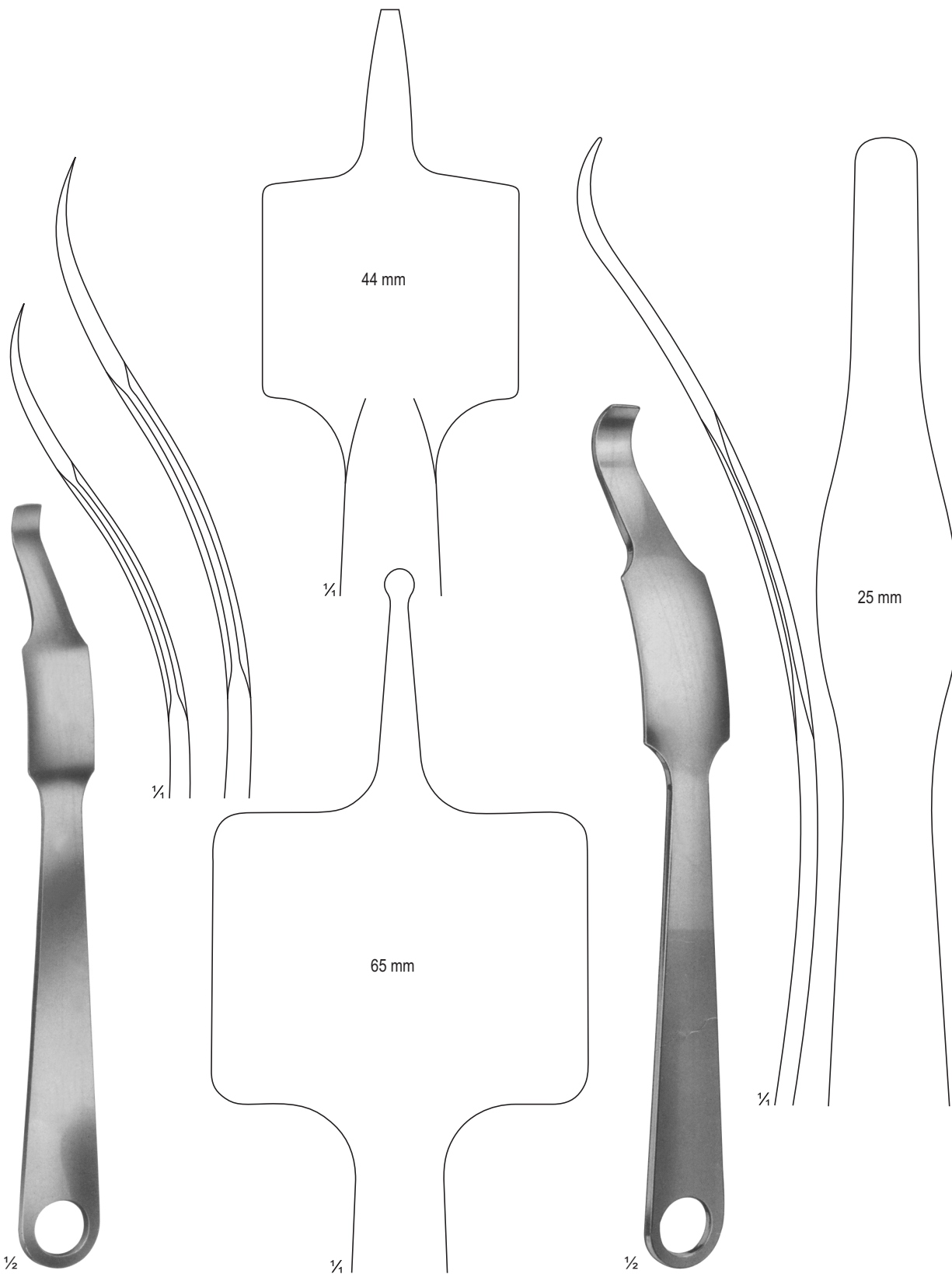

SS-11-118 -
SS-11-119
VERBRUGGE-MULLER
SS-11-118 240 mm
SS-11-119 255 mm

SS-11-120
260 mm

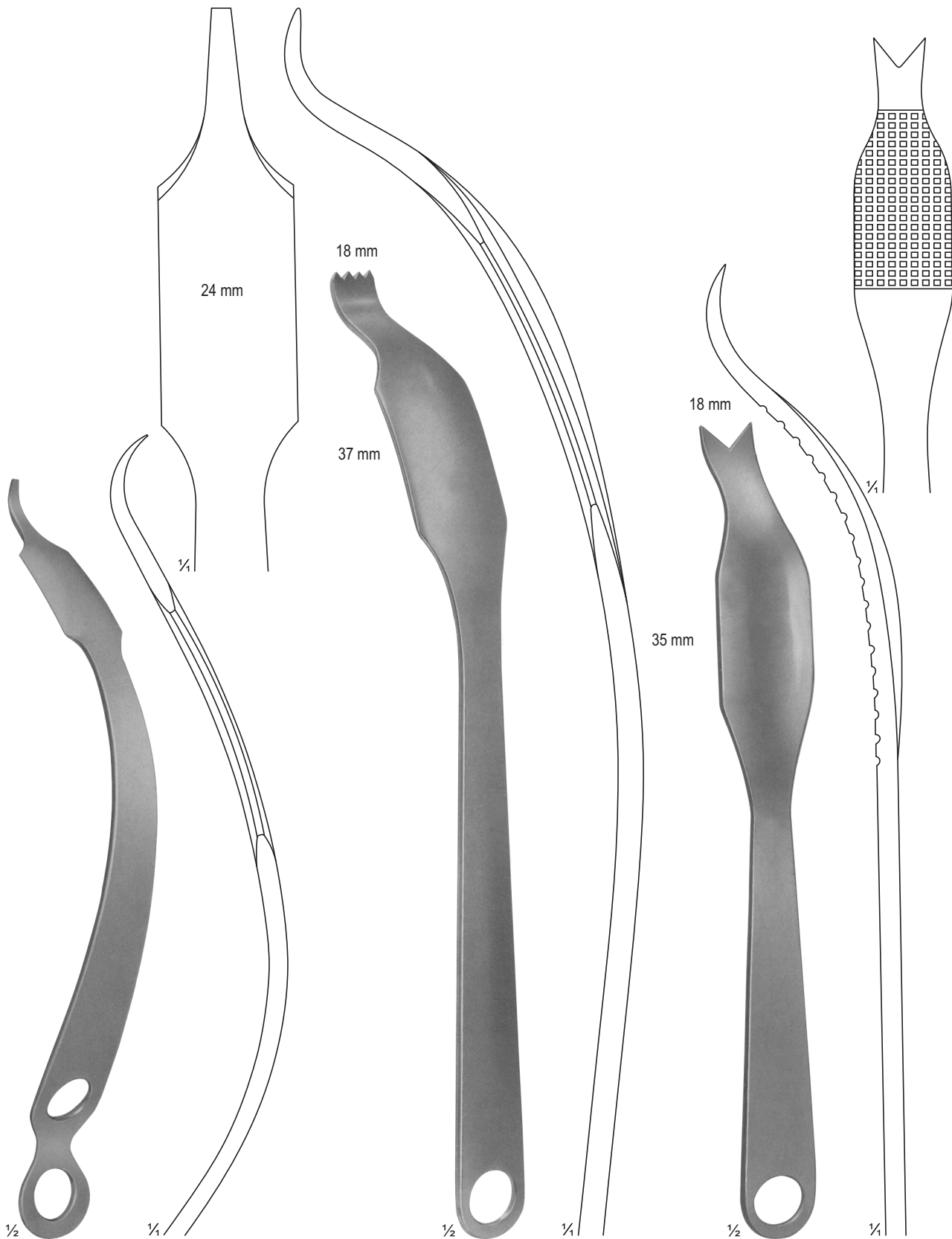

SS-11-121 HOHMANN-ALDINGER
270 mm

SS-11-122 SCHUMACHER mod. WAGNER
345 mm

SS-11-123 SCHUMACHER
290 mm

BONE LEVERS

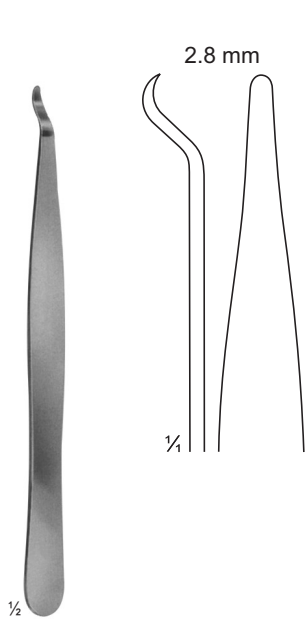

SS-11-124
140 mm

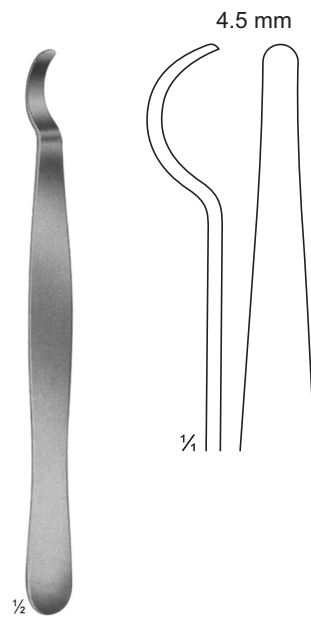

SS-11-125
150 mm

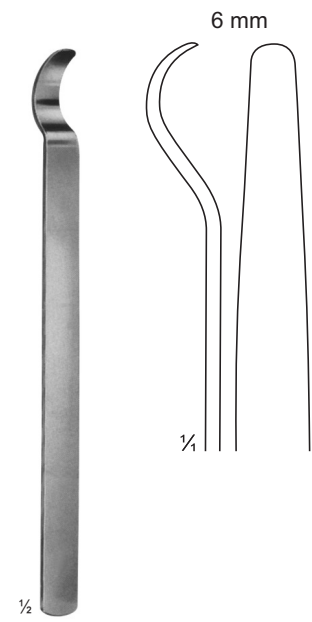

SS-11-126
150 mm

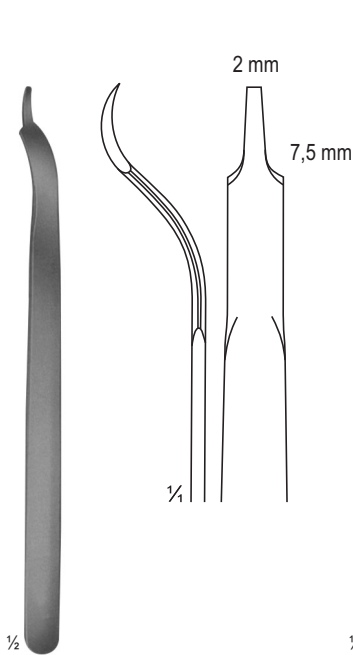

BUCK-GRAMCKO
SS-11-127
150 mm

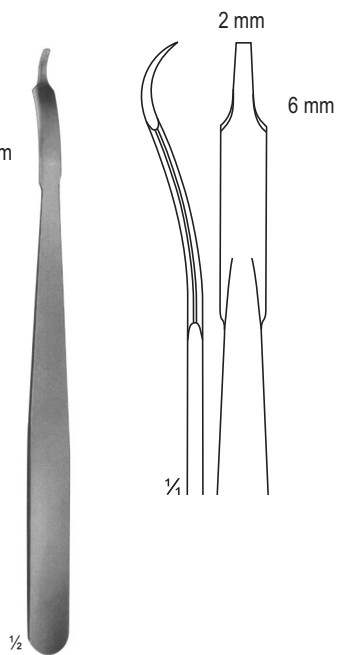

SS-11-128
160 mm

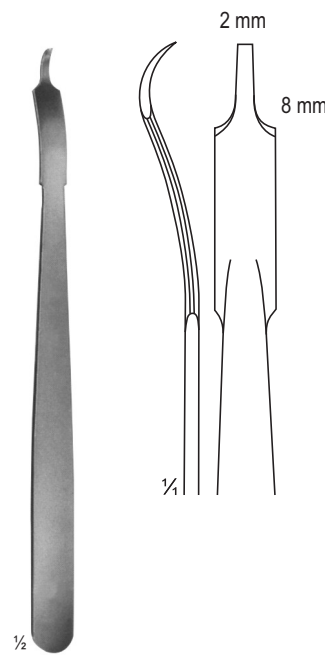

SS-11-129
160 mm

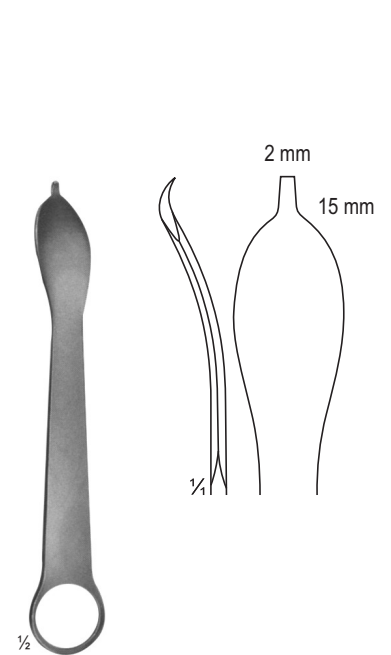

SS-11-130
125 mm

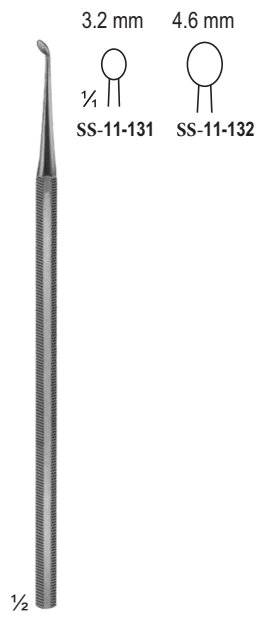

SS-11-131 -
SS-11-132
PARTSCH 150 mm

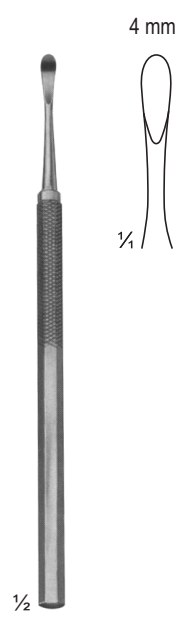

SS-11-133
PARTSCH mod.
LANGE 145 mm

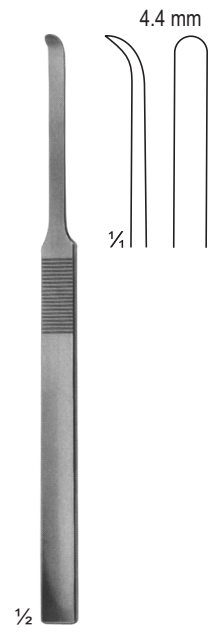

SS-11-134
MC KENTY
155 mm

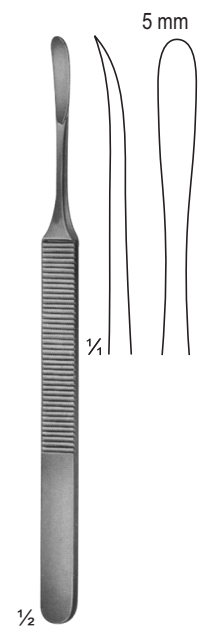

SS-11-135
KONIG
155 mm

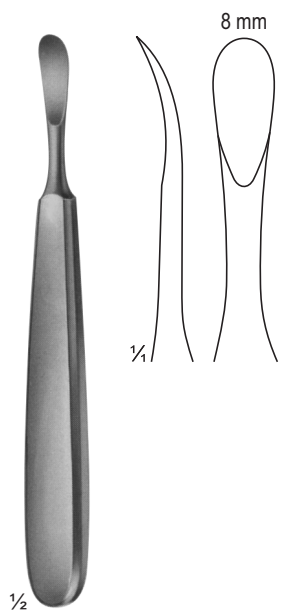

SS-11-136
TRELAT
150 mm

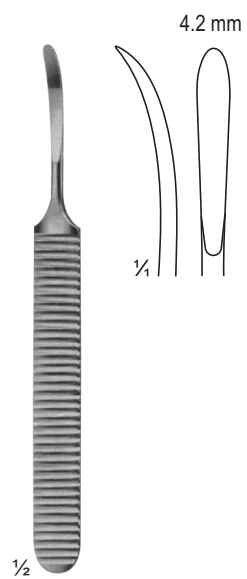

SS-11-137
WILLIGER
140 mm

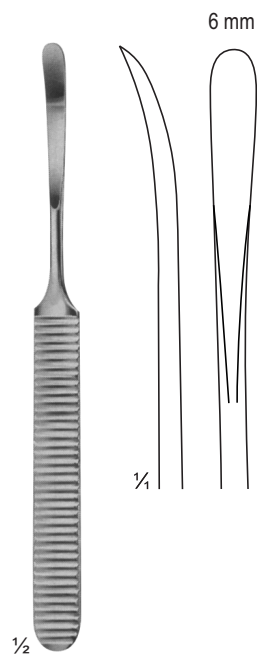

SS-11-138
WILLIGER
160 mm

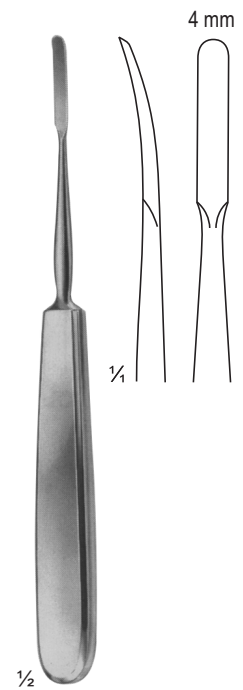

SS-11-139
JOSEPH
170 mm

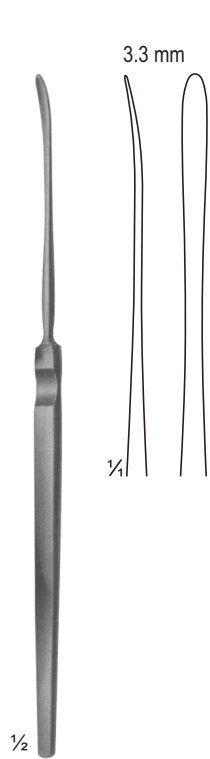

SS-11-140
HALLE
stumpf/blunt
180 mm

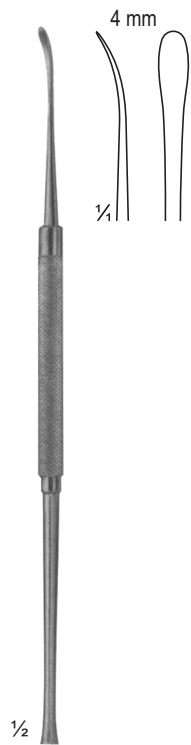

SS-11-141
FREER
stumpf/blunt
190 mm

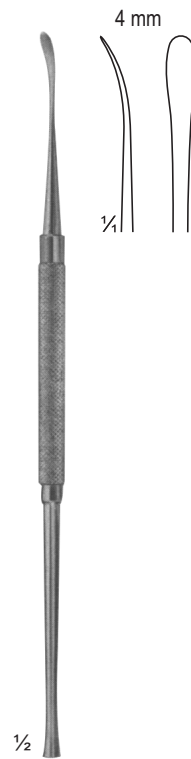

SS-11-142
FREER
stumpf/sharp
190 mm

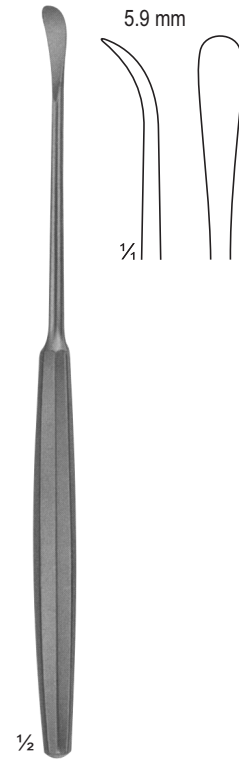

SS-11-143
SEWALL
stumpf/blunt
190 mm

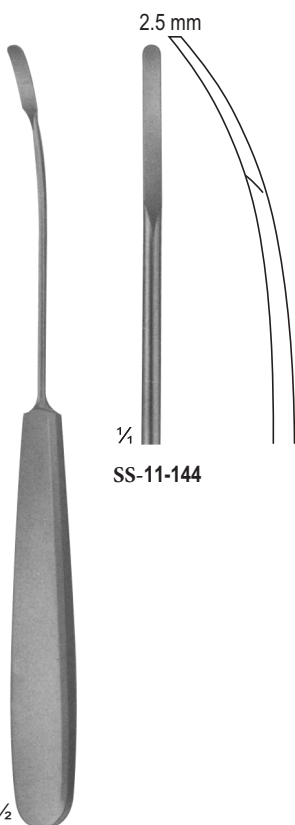

SS-11-144 -
SS-11-146 205
mm

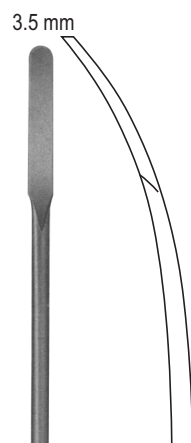

SS-11-145

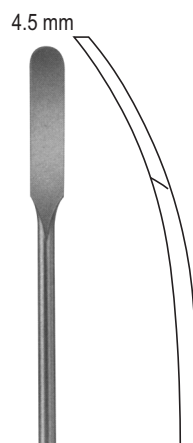

SS-11-146

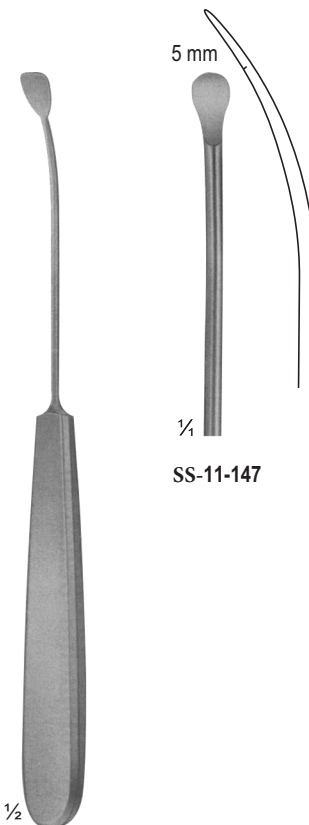

SS-11-147 -
SS-11-148
PAULSEN 205 mm

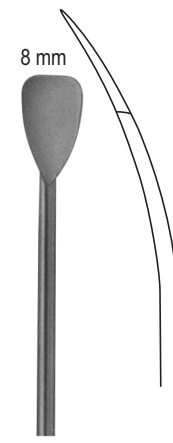

SS-11-148

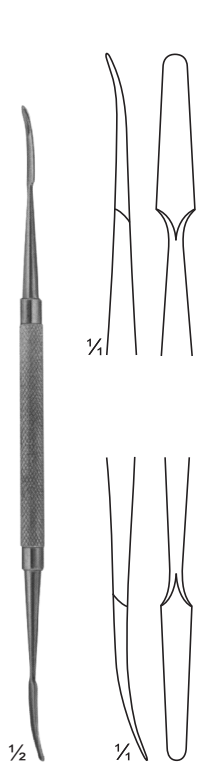

SS-11-149
KILLIAN
sharp/blunt
185 mm

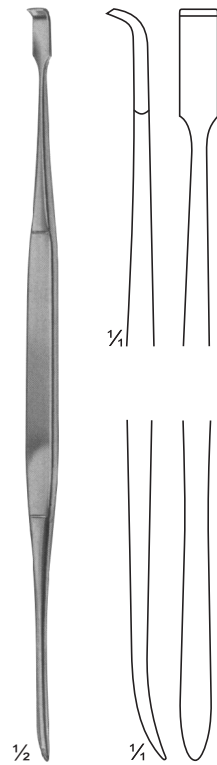

SS-11-150
HOWARTH
sharp/blunt
215 mm

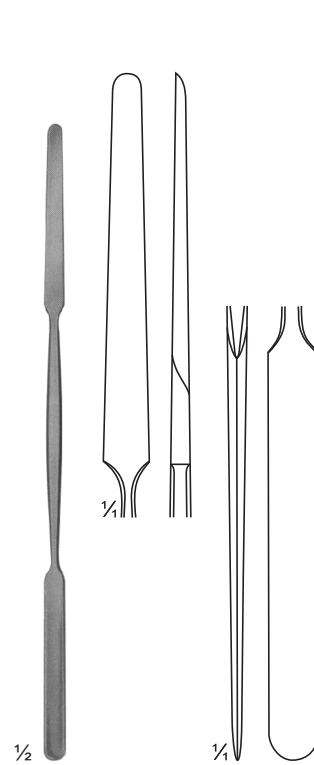

SS-11-151
KILLIAN
sharp/blunt
185 mm

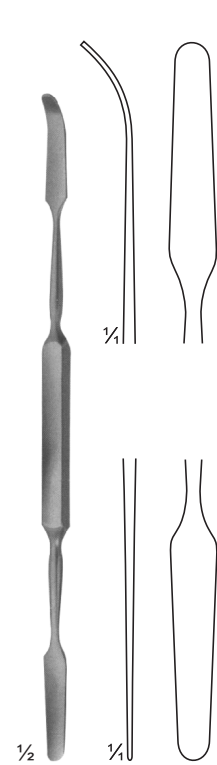

SS-11-152
MAC DONALD
blunt/blunt
185 mm

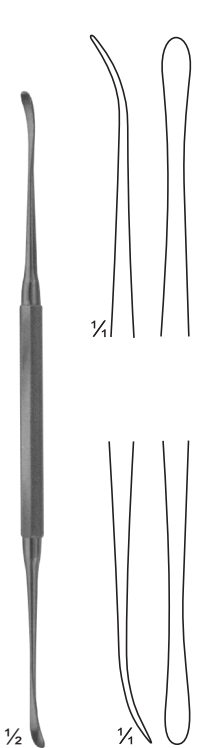

SS-11-153
FREER
sharp/blunt
185 mm

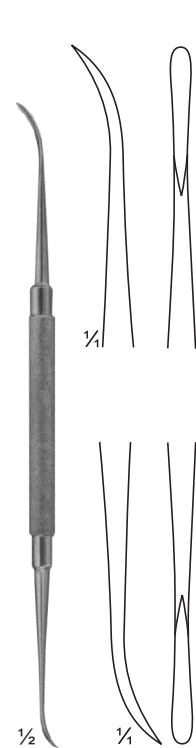

SS-11-154
FREER-YASARGIL
sharp/sharp
185 mm

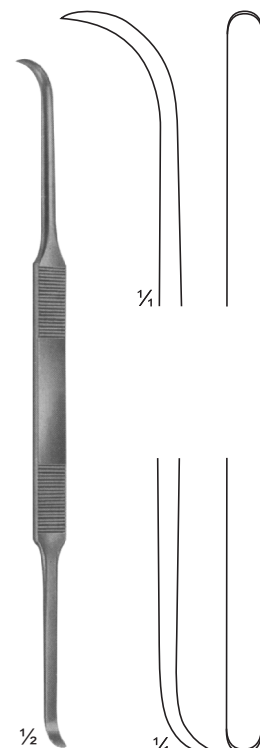

SS-11-155
COTTLE
sharp/sharp
200 mm

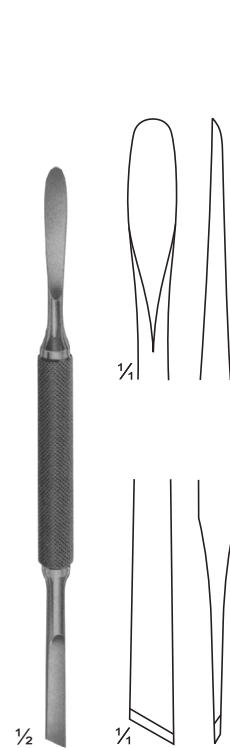

SS-11-156
MEAD
sharp/sharp
165 mm

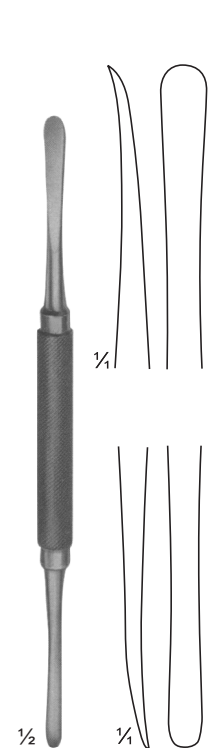

SS-11-157
MOLT
sharp/sharp
180 mm



SS-11-158 -
SS-11-171
MANNERFET
155 mm

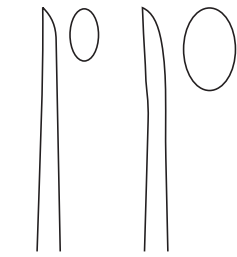

SS-11-158
4 mm

SS-11-159
7 mm

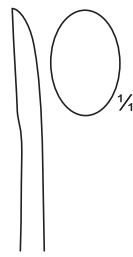

SS-11-160
9 mm



SS-11-163
6 mm



SS-11-164
6 mm

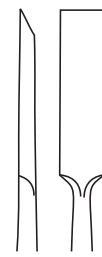

SS-11-165
8 mm

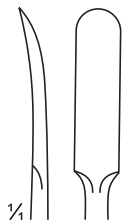

SS-11-161
3 mm

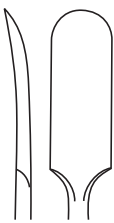

SS-11-162
6 mm

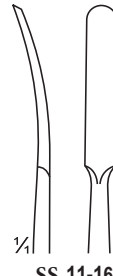

SS-11-166
4 mm



SS-11-167
5 mm



SS-11-168
6 mm



SS-11-169
4 mm
90°



SS-11-170
6 mm
90°



SS-11-171
3,5 mm
45°



SS-11-172 -
SS-11-173 165
mm

6 mm

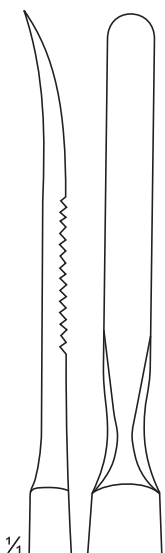

SS-11-172

8 mm

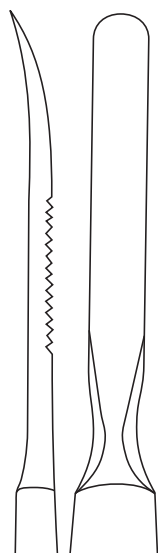

SS-11-173



SS-11-174 -
SS-11-177
ADSON 170 mm

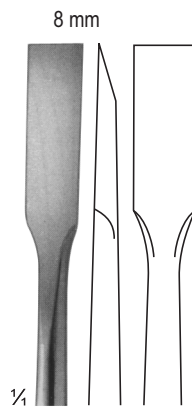

SS-11-174

8 mm

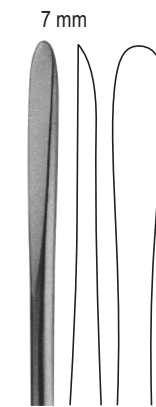

SS-11-175

7 mm

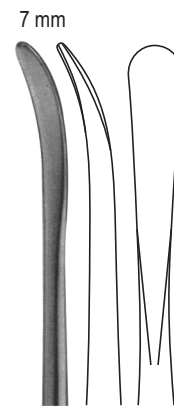

SS-11-176

7 mm

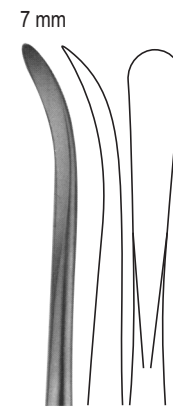

SS-11-177

7 mm

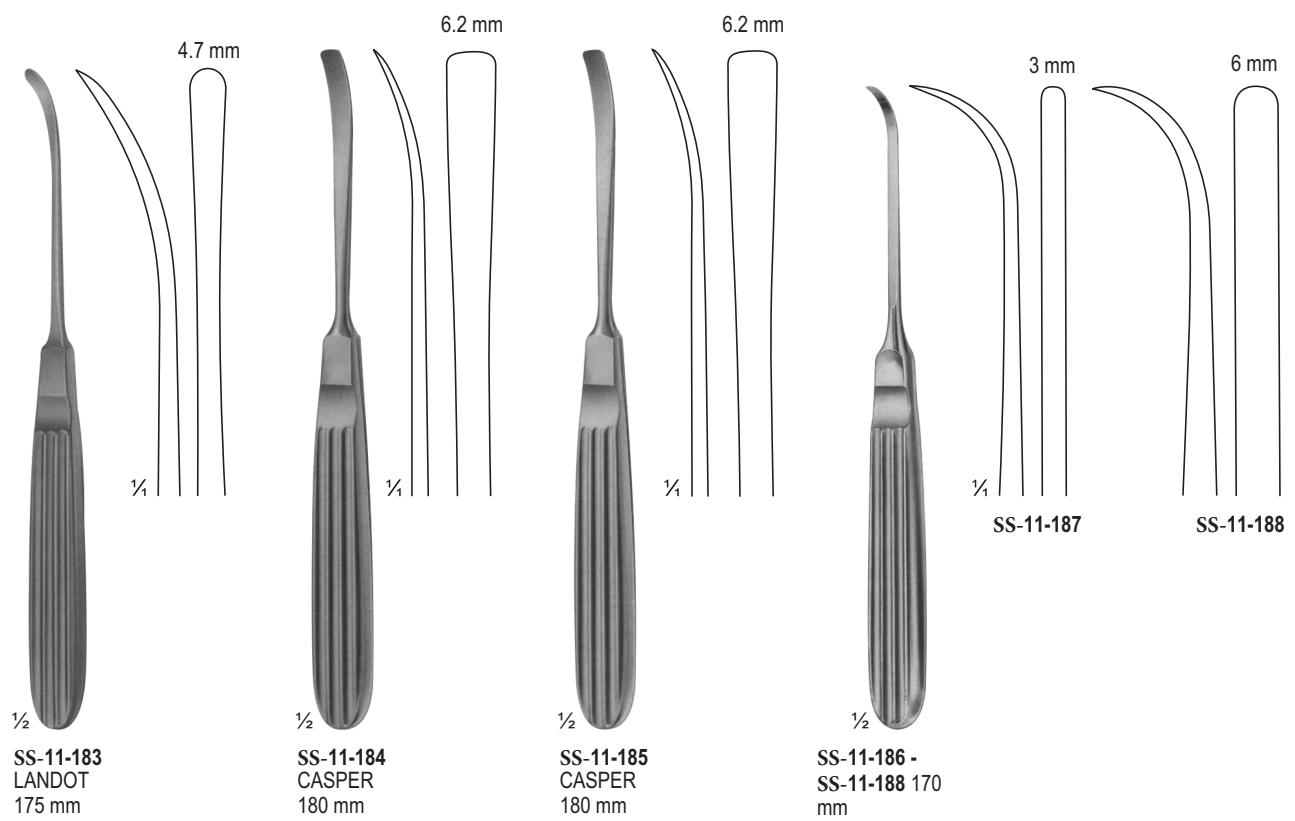
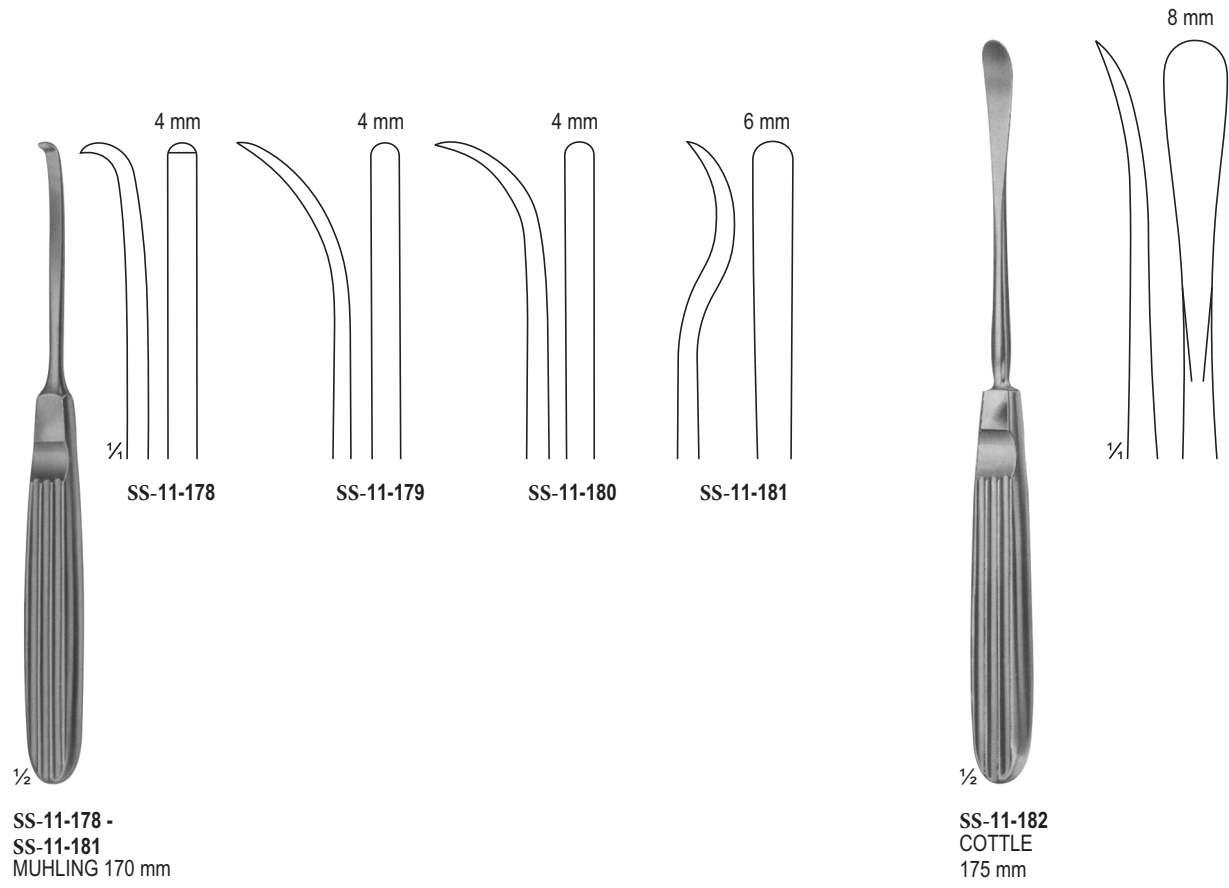

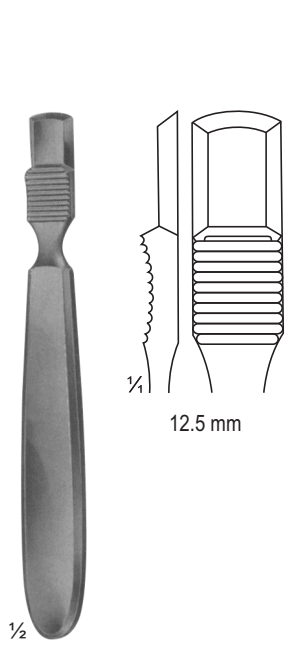

SS-11-189
FARABEU
140 mm

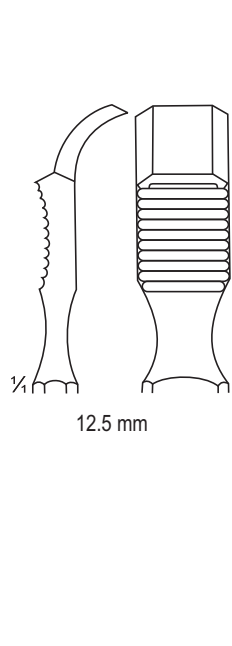

SS-11-190
FARABEU
140 mm

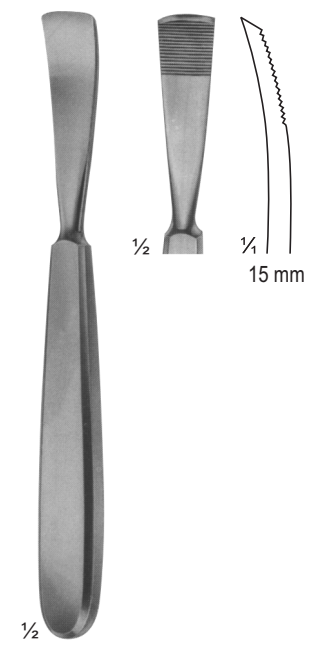

SS-11-191
JANSEN
165 mm

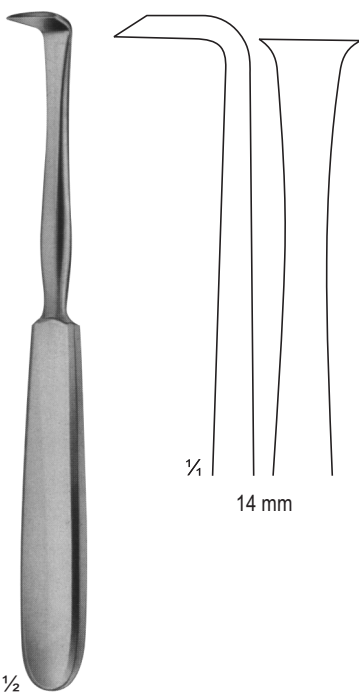

SS-11-192
LANGENBECK
180 mm

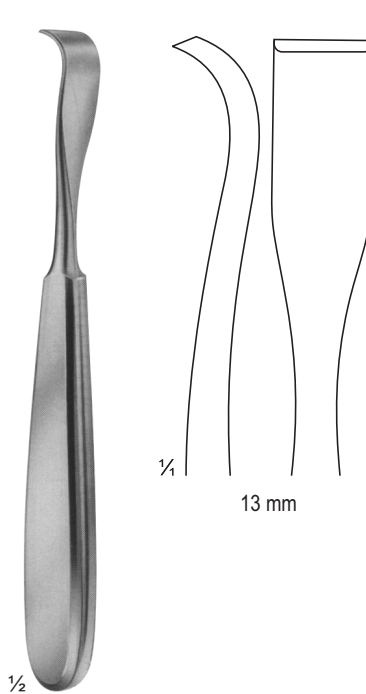

SS-11-193
SCHNEIDER
175 mm

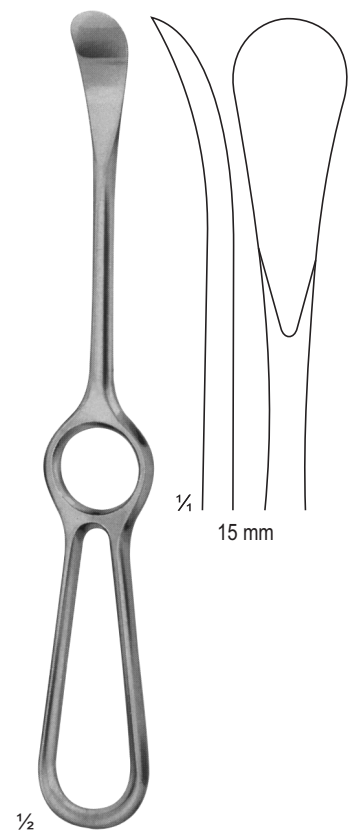

SS-11-194
SEDILLOT
215 mm

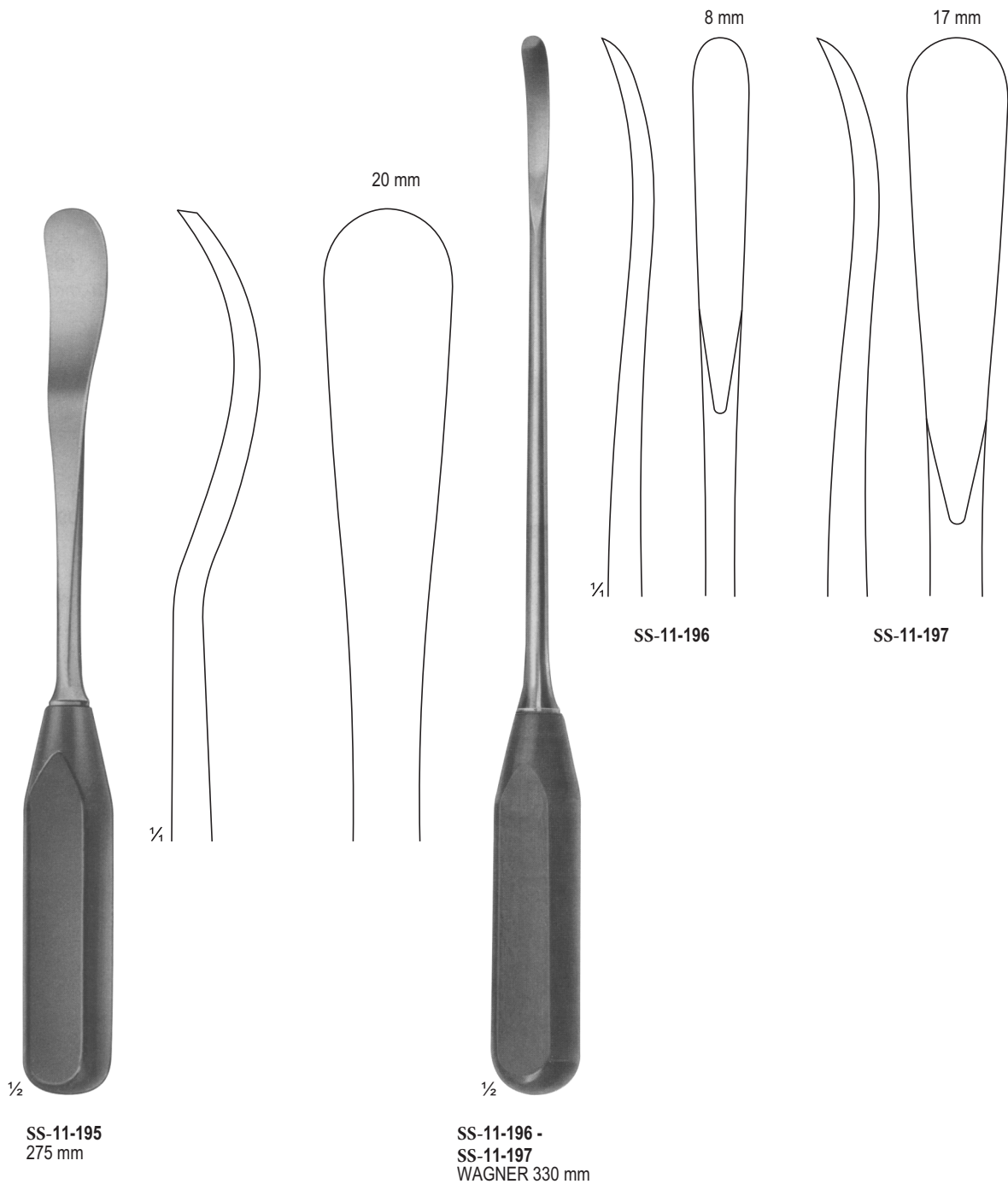

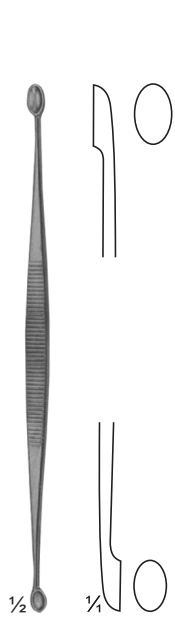

SS-11-198
JACOBSON
140 mm

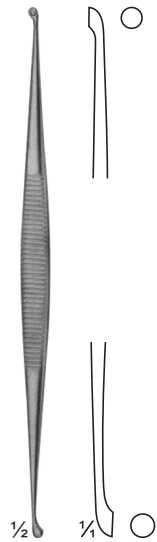

SS-11-199
MARTINI
140 mm

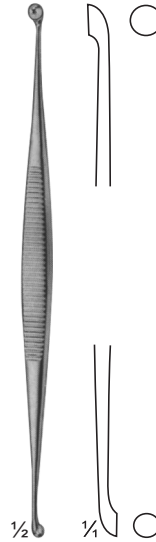

SS-11-200
MARTINI
140 mm



SS-11-201
WILLIGER
145 mm



SS-11-202
JANSEN
160 mm



SS-11-203
BARTH
180 mm

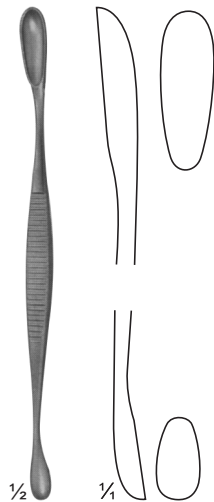

SS-11-204
VOLKMANN
130 mm

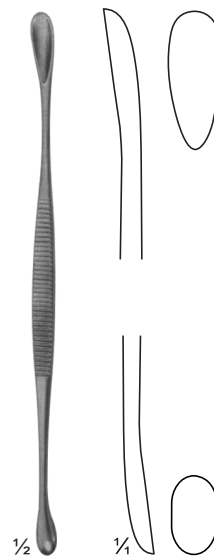

SS-11-205
VOLKMANN
145 mm

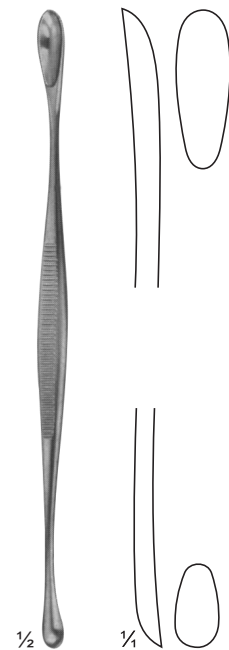

SS-11-206
VOLKMANN
170 mm



SS-11-207
JANSEN
160 mm

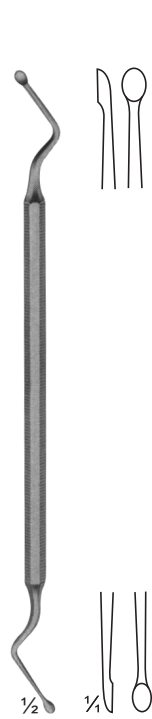

SS-11-208
HEMINGWAY
170 mm

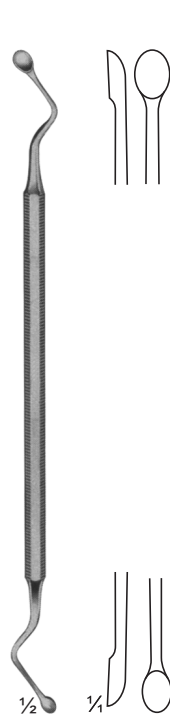

SS-11-209
HEMINGWAY
175 mm

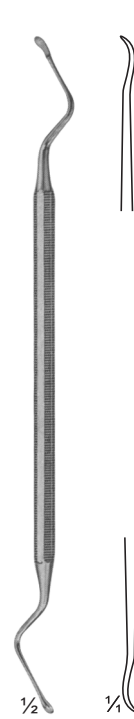

SS-11-210
LUCAS
180 mm

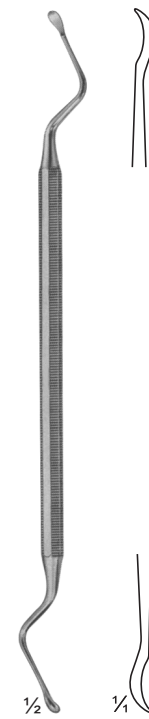

SS-11-211
LUCAS
185 mm



SS-11-212 -
SS-11-213 KERPEL
145 mm



SS-11-214 -
SS-11-215 KERPEL
145 mm

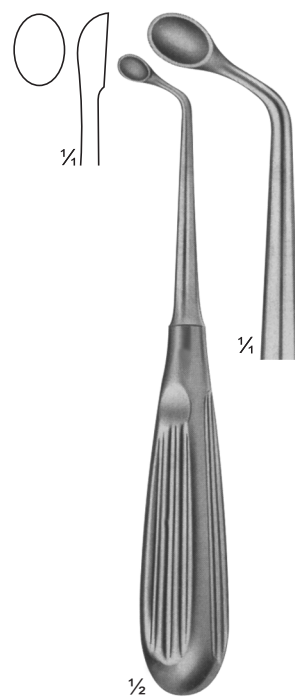

SS-11-216
UFFENDORDE
170 mm



SS-11-217
UFFENDORDE
170 mm



1/2

SS-11-218 -
SS-11-224 BRUNS
165 mm



SS-11-218
3 mm
Fig: 000



SS-11-219
4 mm
00



SS-11-220
5 mm
0



SS-11-221
6 mm
Fig: 1



SS-11-222
8 mm
2



SS-11-223
10 mm
3



SS-11-224
12 mm
4



1/2

SS-11-225 -
SS-11-231
SCHEDE 170 mm



SS-11-225
2.5 mm
Fig: 000



SS-11-226
3.4 mm
00



SS-11-227
4.2 mm
0



RS-128
5.2 mm
Fig: 1



RS-129
6.3 mm
2



RS-130
7.4 mm
3



RS-131
8 mm
4



1/2

SS-11-232 -
SS-11-241
VOLKMANN
170 mm



SS-11-232
2,8 mm
Fig: 0000



SS-11-233
3,6 mm
000



SS-11-234
4,4 mm
00



SS-11-235
5,2 mm
0



SS-11-236
6,8 mm
1



SS-11-237
8,5 mm
Fig: 2



SS-11-238
10 mm
3



SS-11-239
11,5 mm
4



SS-11-240
13 mm
5

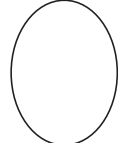

SS-11-241
14,5 mm
6



1/2

SS-11-242 -
SS-11-243
WILLIGER 170 mm



SS-11-242
3,4 mm
Fig: 00



SS-11-243
5,2 mm
1

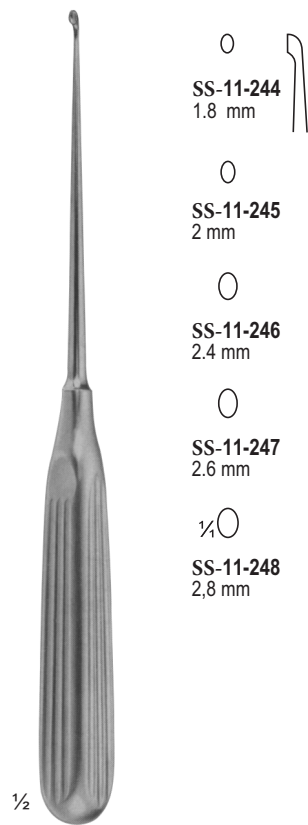

SS-11-244 -
SS-11-248
LEMPERT 215 mm

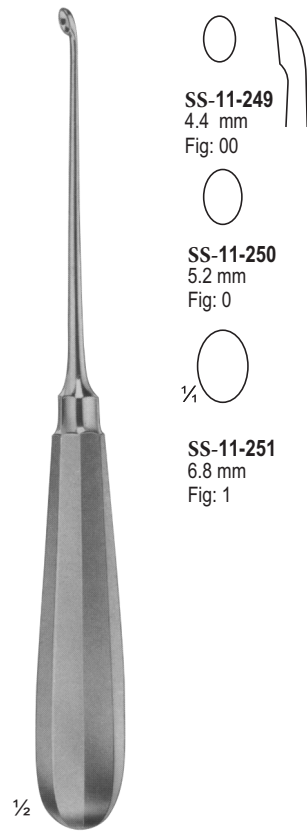

SS-11-249 -
SS-11-251 HALLE
215 mm

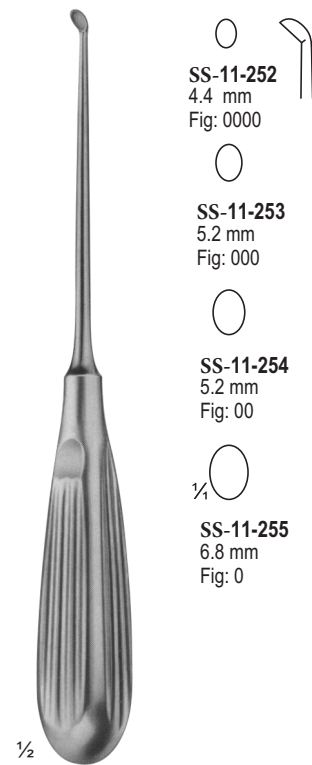

SS-11-252
-
DUBOIS
DAUBENSPECK 200
mm



SS-11-256 -
SS-11-259 250
mm

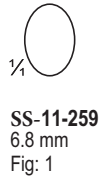

SS-11-260 -
SS-11-263 250
mm



SS-11-264 -
SS-11-266 BUSHE
250 mm

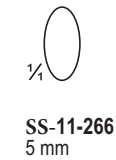

¼ 0

Fig. 1
SS-11-267

¼ 0

Fig. 1
SS-11-273

¼ 0

Fig. 1
SS-11-2179

0

Fig. 2
SS-11-268

0

Fig. 2
SS-11-274

0

Fig. 2
RS-1SF-11-2

0

Fig. 3
SS-11-269

0

Fig. 3
SS-11-275

0

Fig. 3
RS-1SF-11-2

0

Fig. 4
SS-11-270

0

Fig. 4
RS-1SF-11-2

0

Fig. 4
SS-11-282



½

MODELL USA
Oval, With Hollow Handle
SS-11-267 - SS-11-272
165 mm

0

Fig. 5
SS-11-271

0

Fig. 5
SS-11-277

0

Fig. 5
SS-11-283

0

Fig. 6
SS-11-272

0

Fig. 6
SS-11-278

0

Fig. 6
SS-11-284



½

MODELL USA
Oval, With Hollow Handle
SS-11-273 - SS-11-278
165 mm



½

MODELL USA
Oval, With Hollow Handle
SS-11-279 - SS-11-284
16 mm

WE HAVE ALL RANGE OF INSTRUMENTS



CONTACT INFO



+92-340 0473111



swisons.ind@gmail.com



www.swisons.com



Small Industrial Estate, Sialkot 51310 Pakistan

Get your high quality Instruments