



SWISONS

SURGICALS

- Mallets
- Tempers, Chisels, Gouges Bone Holding Forceps
- Rongeurs Bone Cutting Forceps
- Meniscus Instruments Wire Extension
- Hand Drills, Awls Reamers
- Bone Biopsy Instruments
- Finger Nail Instruments



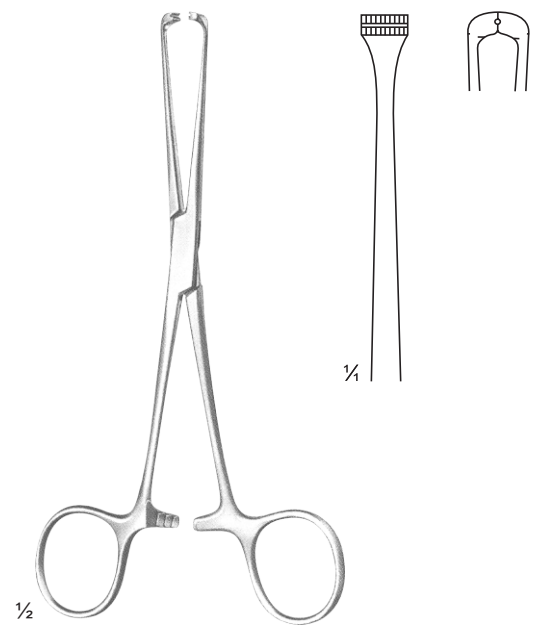

STEINMANN
SS-19-101
160 mm

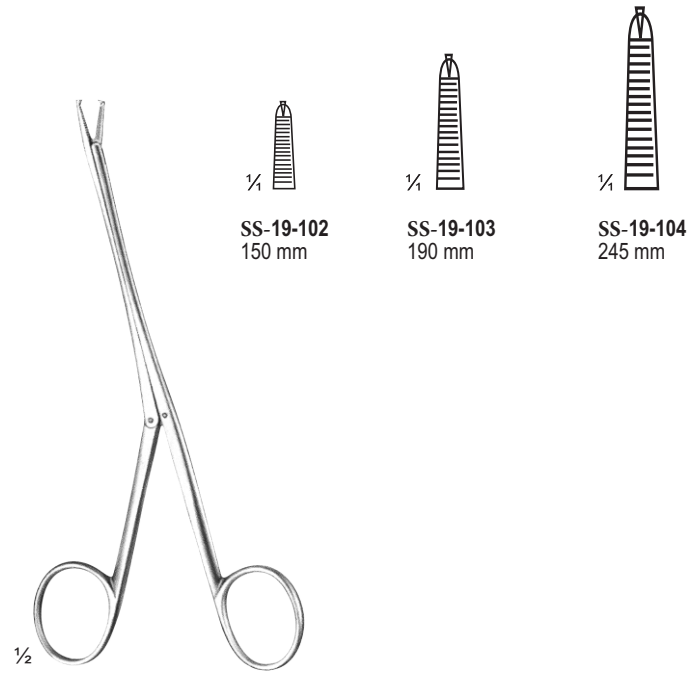

BRAND
SS-19-102 -
SS-19-104

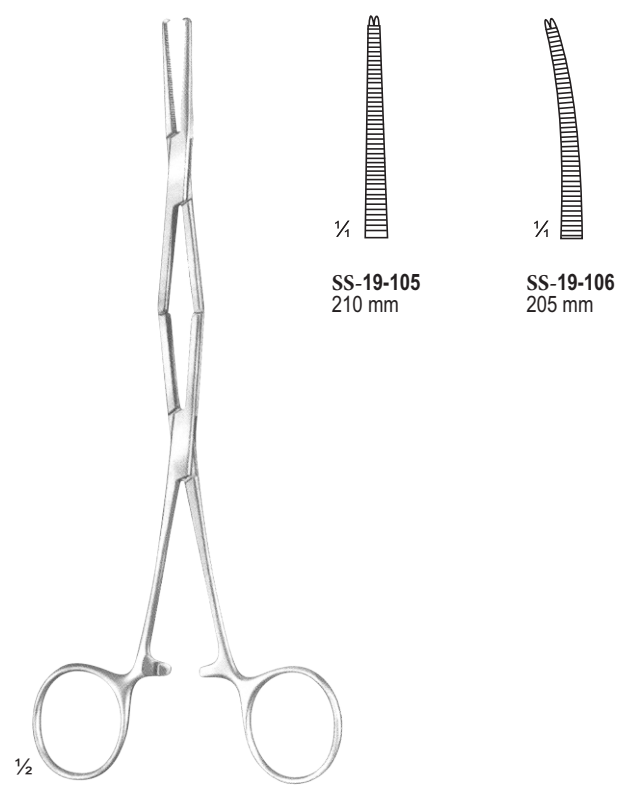

SS-19-105 - SS-19-106

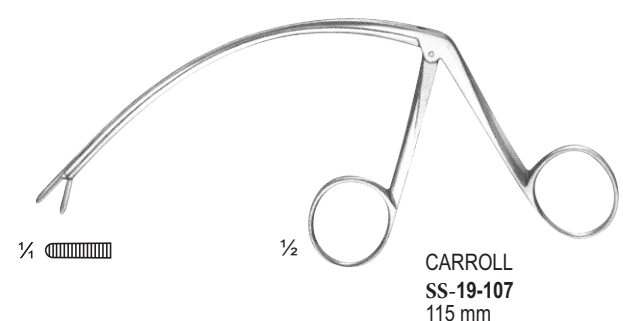

CARROLL
SS-19-107
115 mm

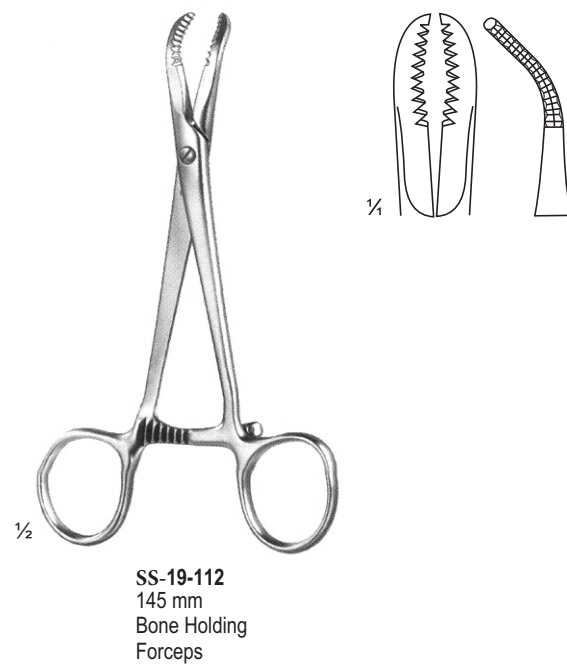
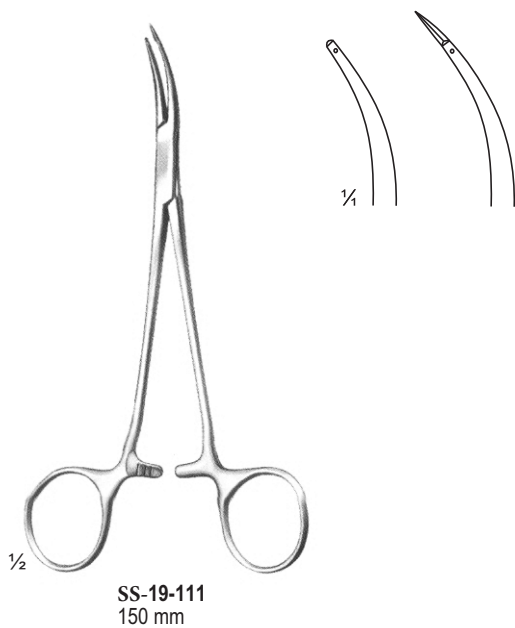
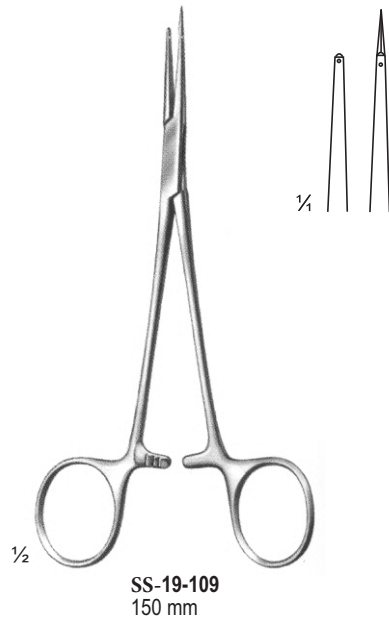
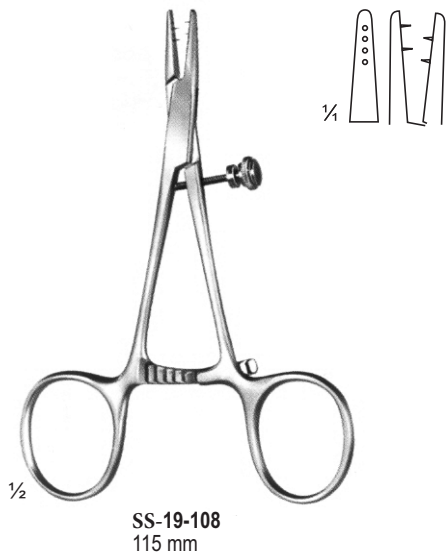



Repositioning forceps,
for small fragments
SS-19-113
135 mm

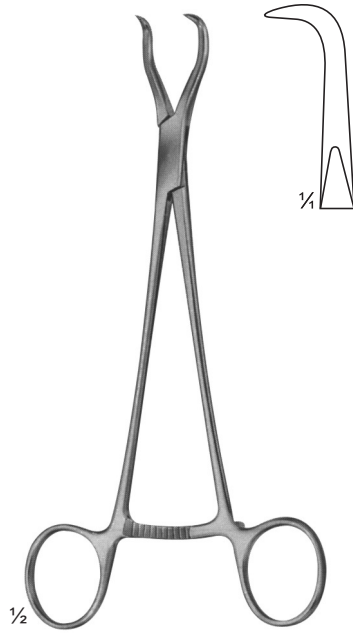

HAASE
Repositioning forceps,
for mandibular
fractures
SS-19-114
165 mm

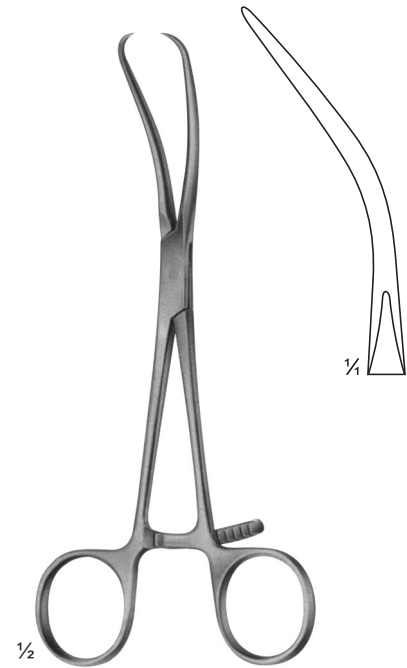

REILL
Repositioning forceps,
SS-19-115
170 mm

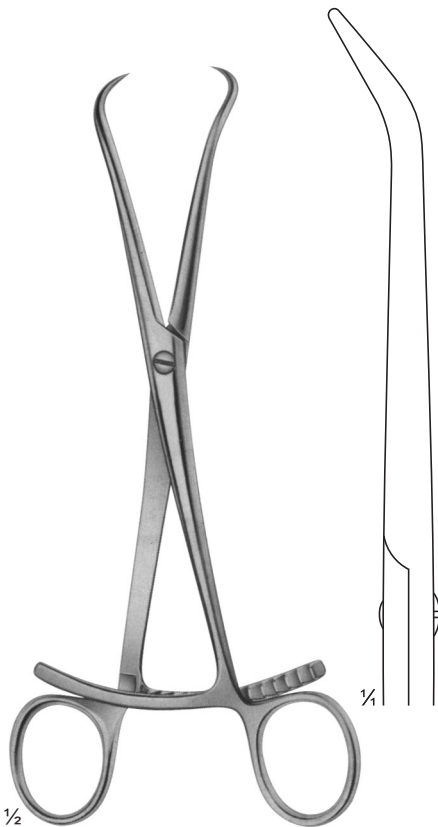

Repositioning forceps
SS-19-116
205 mm

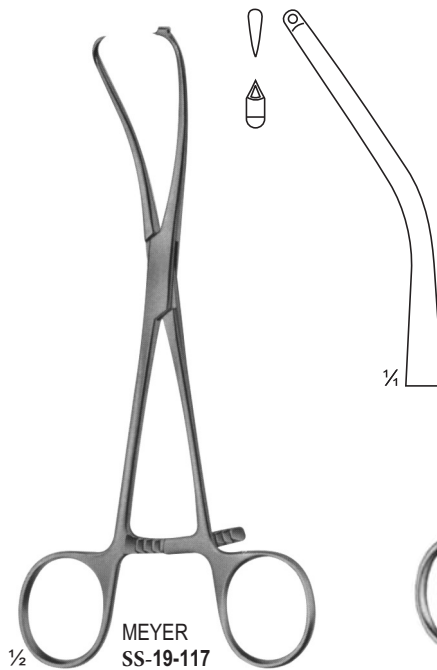

MEYER
SS-19-117
Repositioning forceps for
fingers, with drill guide
for KIRSCHNER wires
up to diam. 1.0 mm 17
cm

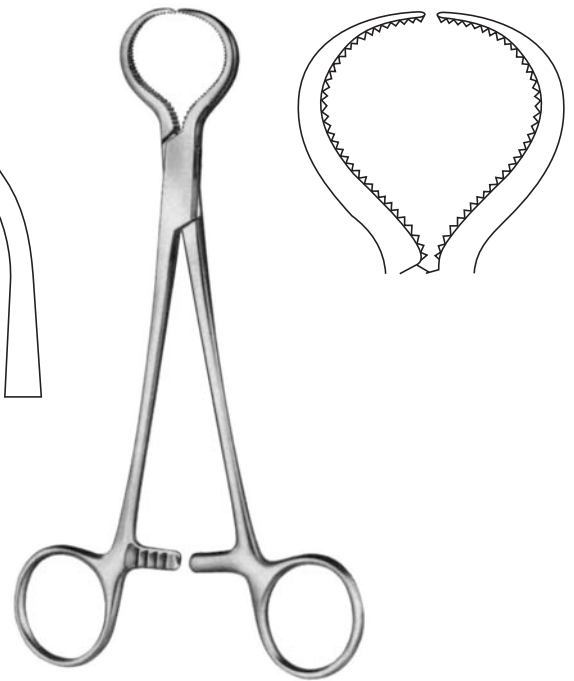

LEWIN
SS-19-118
180 mm

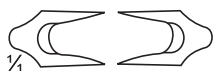

PATELLA
FORCEPS
SS-19-119
185 mm



Forceps with
ratchet fixation
SS-19-120
140 mm



SS-19-121
120 mm

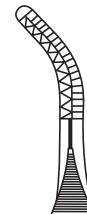

SETTER
SS-19-122
135 mm



SETTER
SS-19-123
170 mm



SETTER
SS-19-124
235 mm

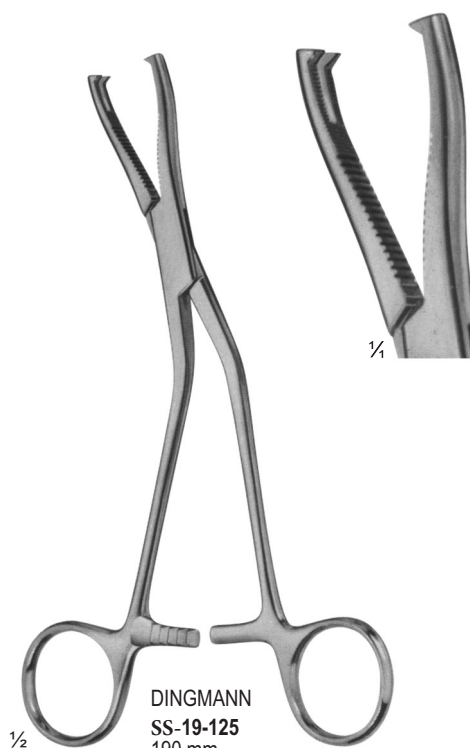

DINGMANN
SS-19-125
190 mm

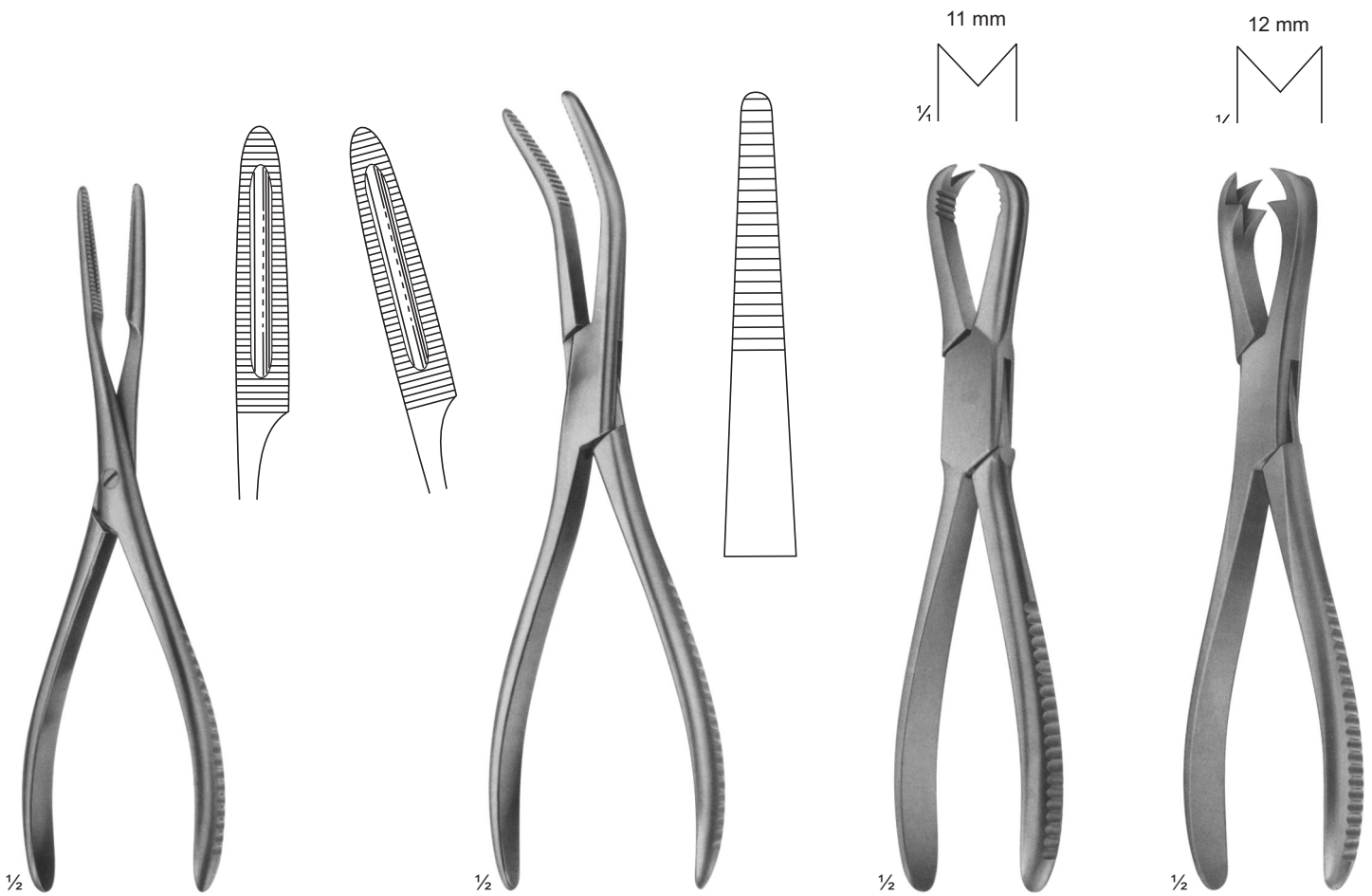

Sequestrum
forceps
SS-19-126
200 mm

VAN BUREN
Sequestrum
forceps
SS-19-127
230 mm

LANGENBECK
Sequestrum
forceps
SS-19-128
205 mm

FERGUSSON
SS-19-129
205 mm

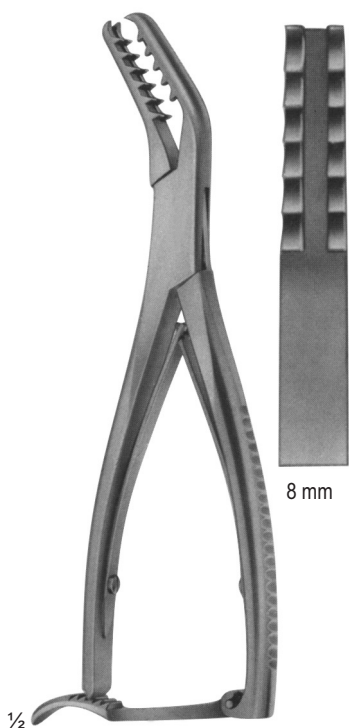

SEM B
SS-19-130
190 mm

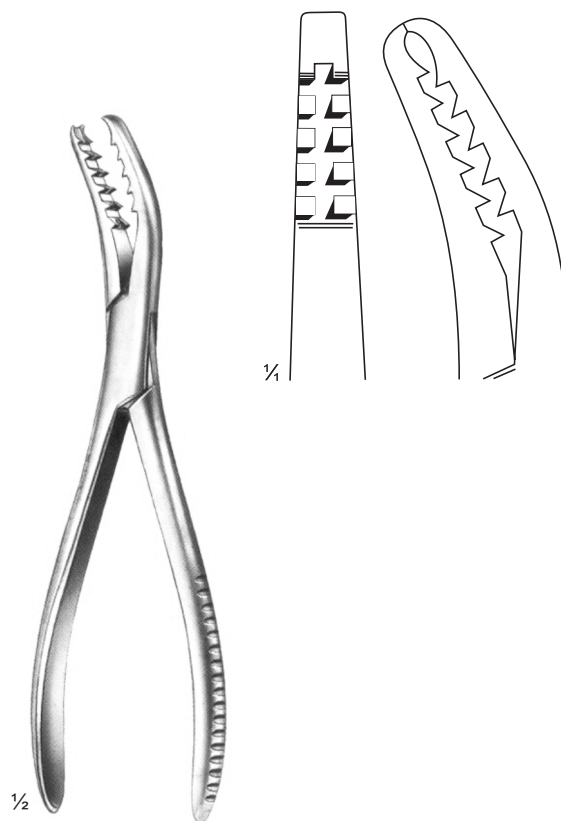
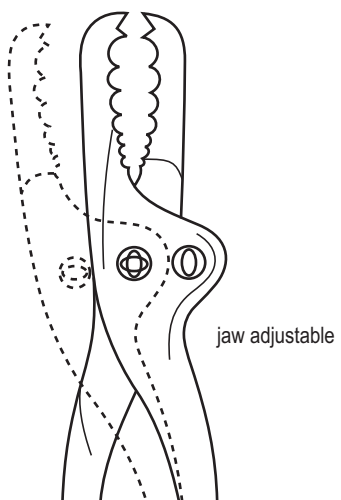

SEM B
SS-19-131
195 mm

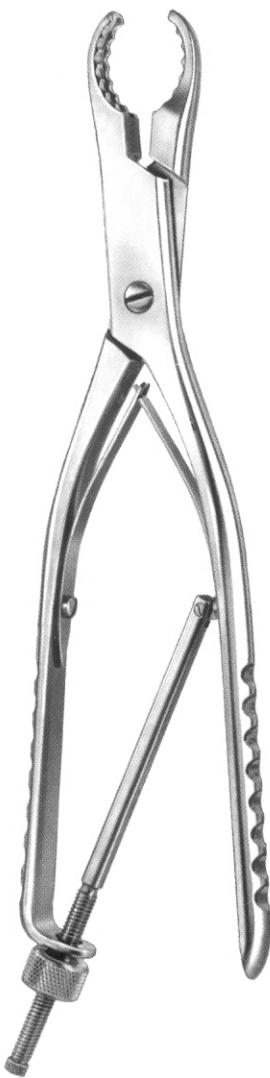
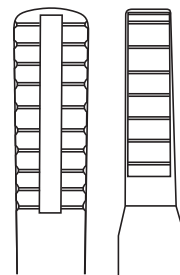
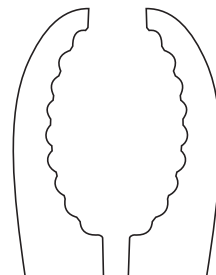
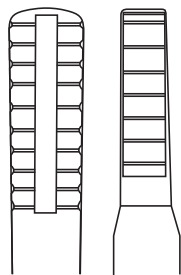
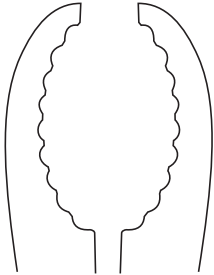

1/2

ULRICH
SS-19-132 -
SS-19-134 With thread
Fixation

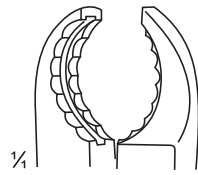

1/4

SS-19-132
230 mm

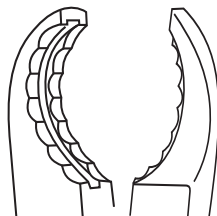

SS-19-133
250 mm

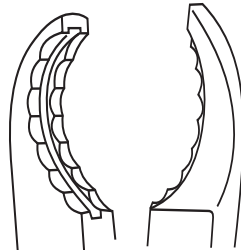

SS-19-134
280 mm



1/2

ULRICH
SS-19-135 -
SS-19-137 With thread
Fixation

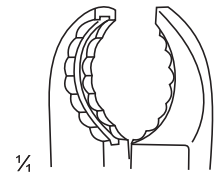

1/4

SS-19-135
230 mm

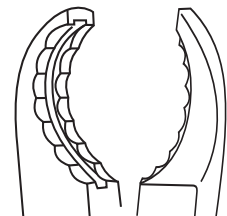

SS-19-136
250 mm

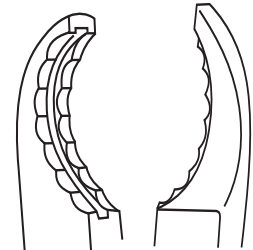

SS-19-137
270 mm



FARABEU
SS-19-138
230 mm



FARABEU
SS-19-139
255 mm



FARABEU-LAMBOTTE
SS-19-140
255 mm

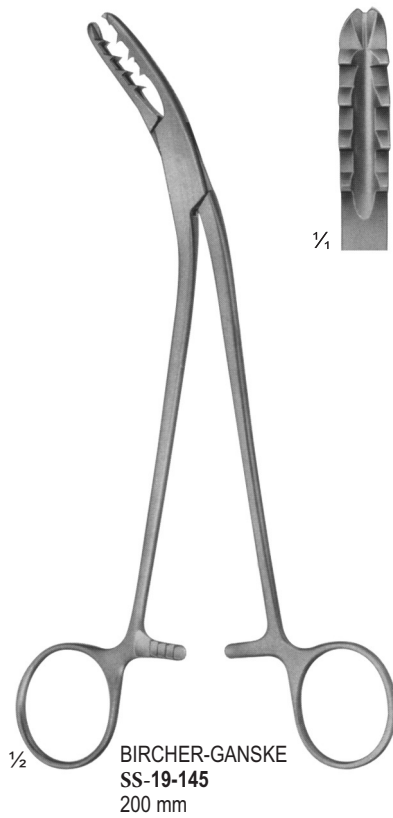
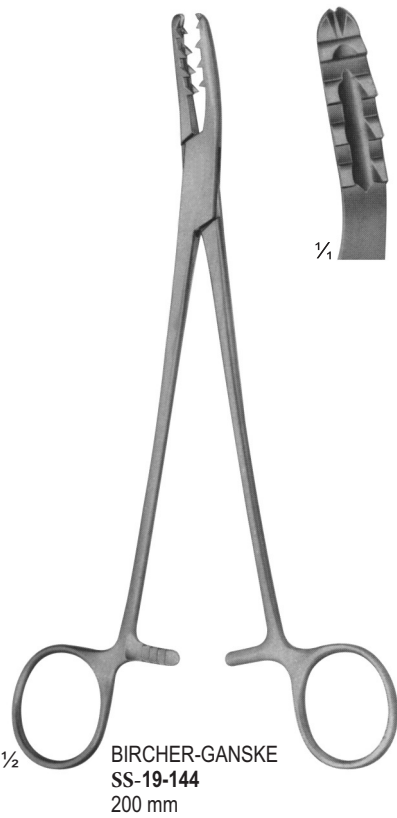
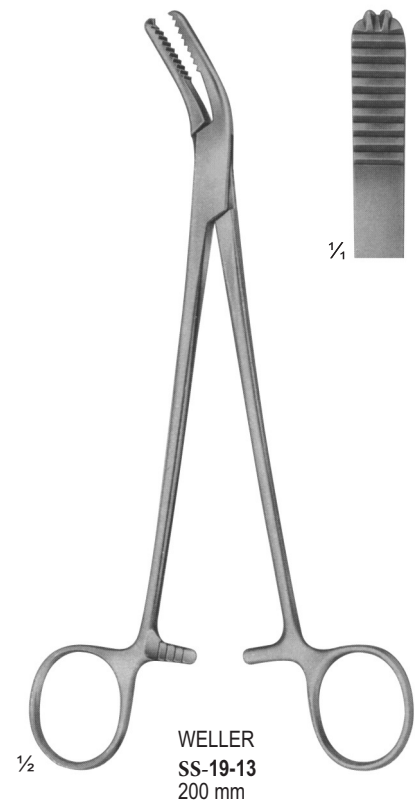
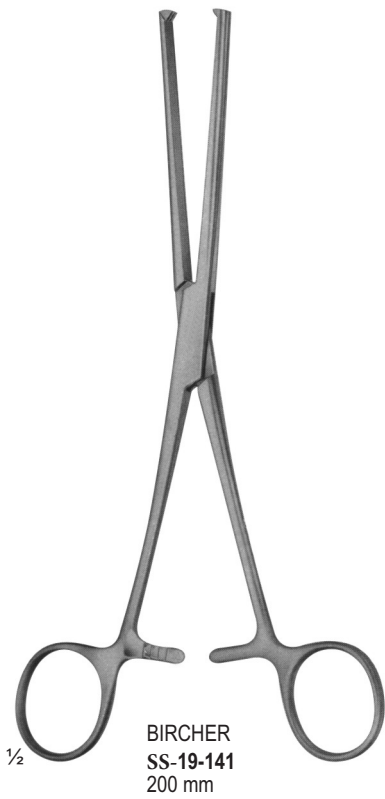

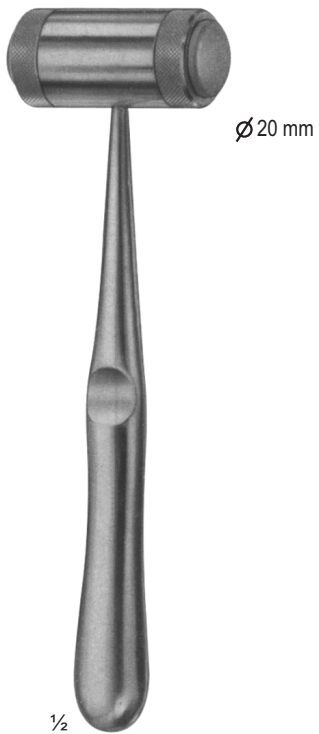

SS-19-147 MEAD
185 g
with interchangeable
plastic disks
190 mm
pair of spare disks

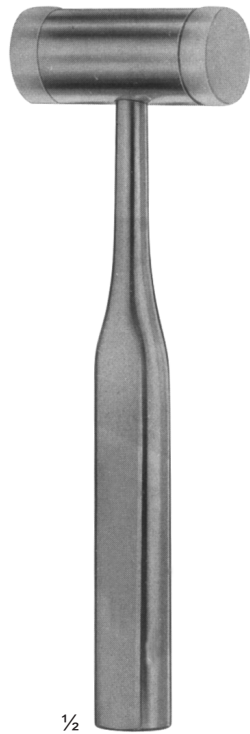

SS-19-148
140 g
with interchangeable
plastic disks
185 mm
SS-19-149
pair of spare disks



SS-19-150 COTTLE
140 g
1 Seite convex
1 Side convex
185 mm

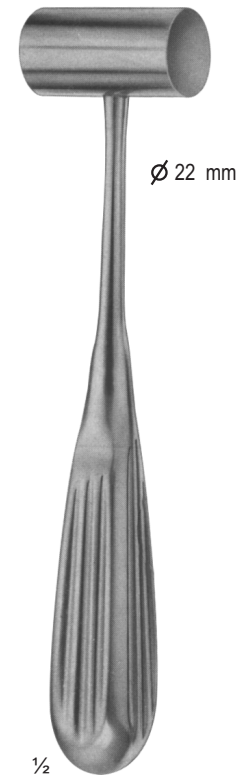

SS-19-151
165 g
lead filled head
190 mm

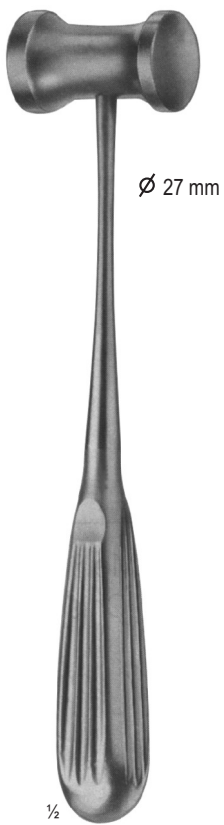

HAJEK
140 g
SS-19-152
215 mm



ST-053
215 g
with interchangeable
plastic disks
245 mm
ST-054
pair of spare disks

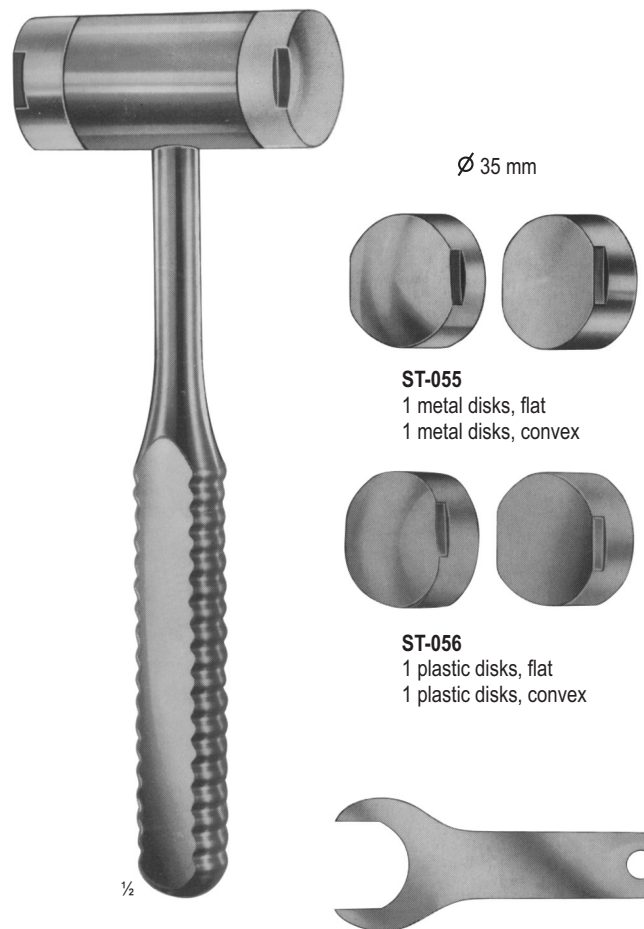

WAGNER
complete with:
1 pair of metal disks and
1 pair of plastic disks and
1 wrench 566
ST-055 - ST-057
235 mm

Mallet without disks 130 g



BERGMANN
SS-19-158
245 mm

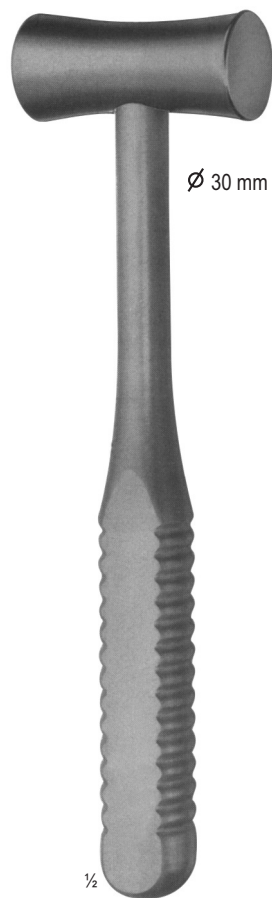

BERGMANN
SS-19-159
235 mm



OMBREDANNE
SS-19-160
240 mm

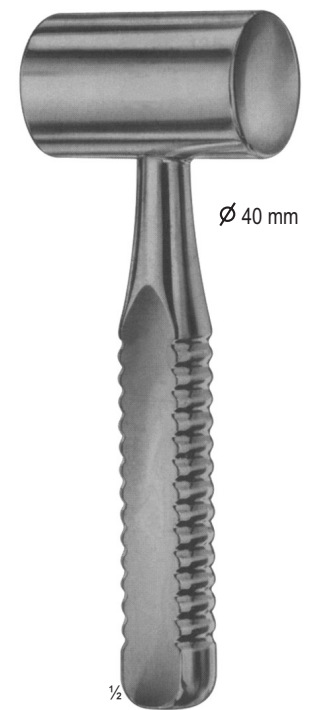

HEATH
copper filled head
700 g
SS-19-161
185 mm



1/2

WILLIGER
 SS-19-162 -
 SS-19-164 Lead Filled

SS-19-162	
Weight	Head
275 g	Ø 26
SS-19-163^m	
Weight	Head
320 g	Ø 28
SS-19-164^m	
Weight	Head
340 g	Ø 30
	mm



1/2

DOYEN
 SS-19-165 -
 SS-19-167

SS-19-165^m	
Weight	Head
120 g	Ø 25
SS-19-166^m	
Weight	Head
180 g	Ø 30
SS-19-167^m	
Weight	Head
260 g	Ø 35
	mm

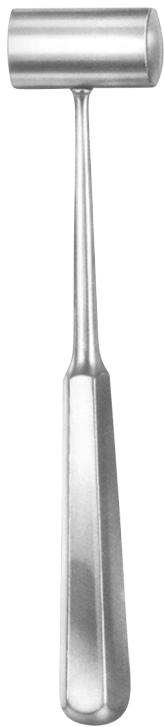

1/2

PARTSCH
SS-19-16
 With Hollow Handle
 190 mm

Weight	Head
175 g	Ø27 mm



VIKERS
SS-19-169
 190 mm

Weight	Head
185 g	Ø25 mm



HERBERT
SS-19-17
 For Ulna Head Prosthesis
 190 mm

Weight	Head
215 g	Ø25 mm

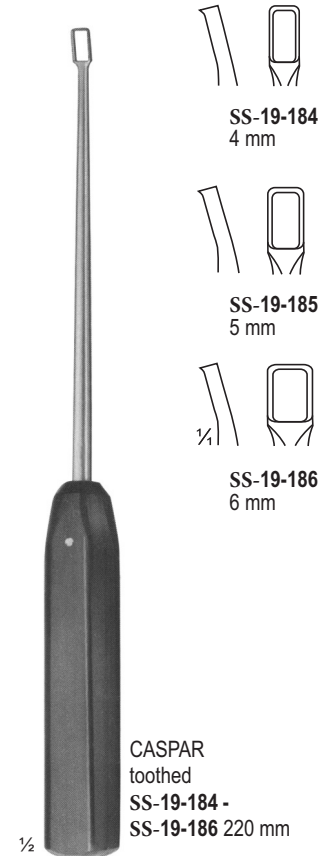
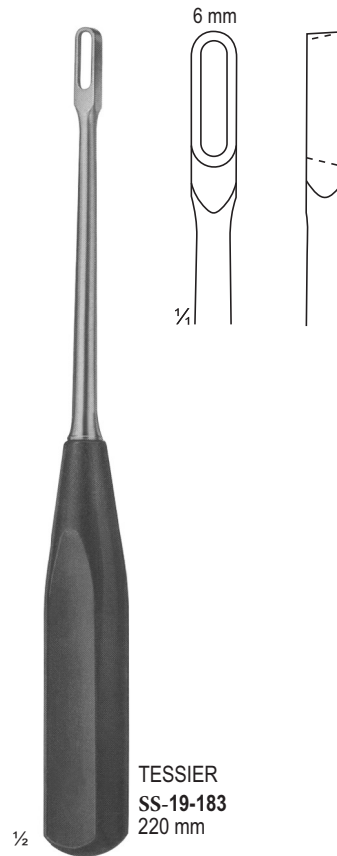
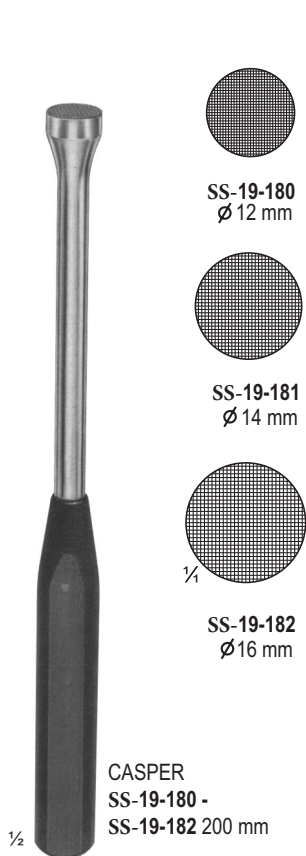
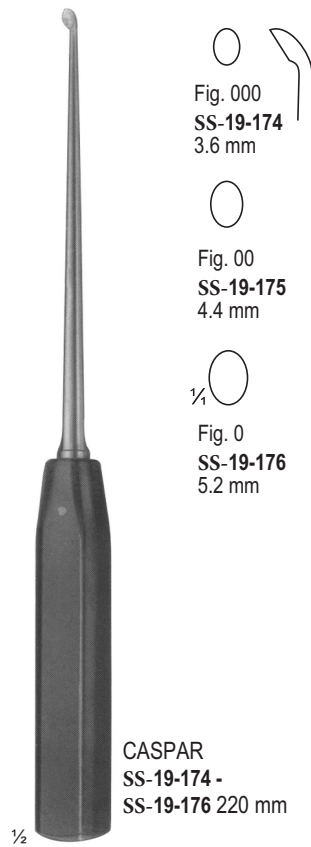
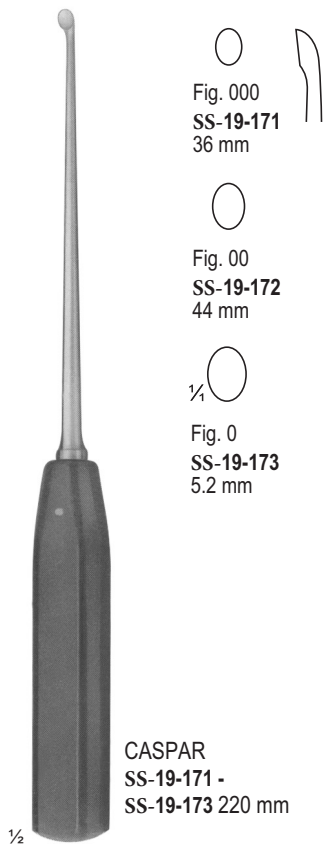

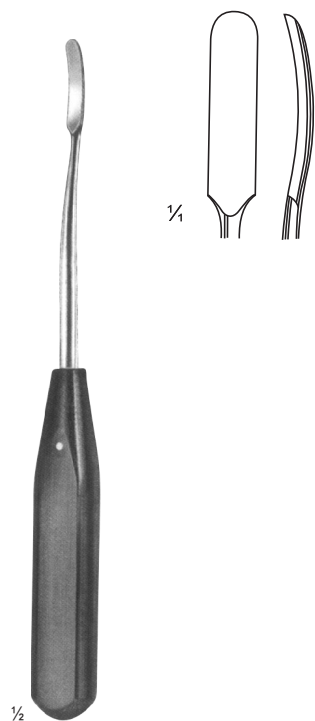

SS-19-187
180 mm
6 mm

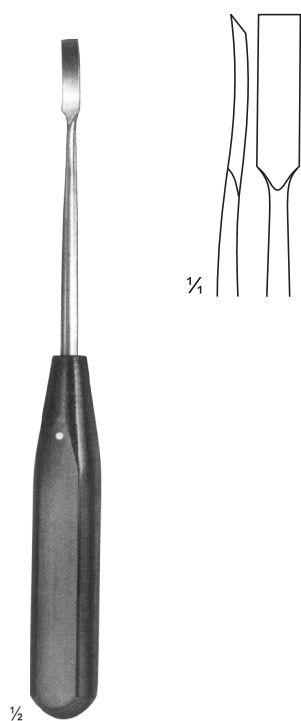

SS-19-188
180 mm
6 mm

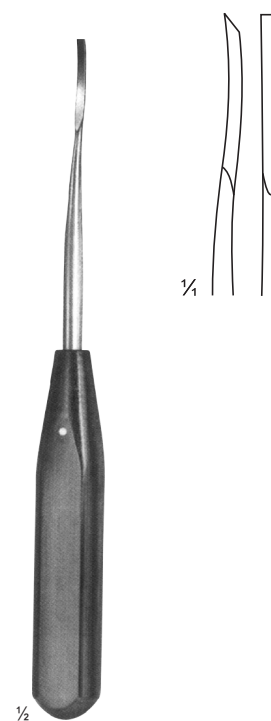

SS-19-189
180 mm
3 mm

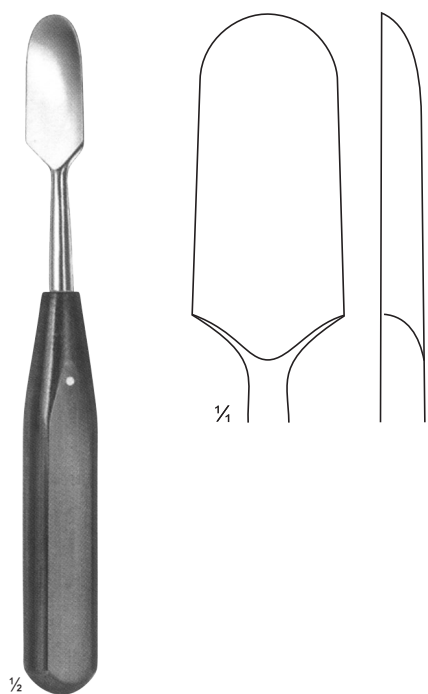

SS-19-190
180 mm
20 mm

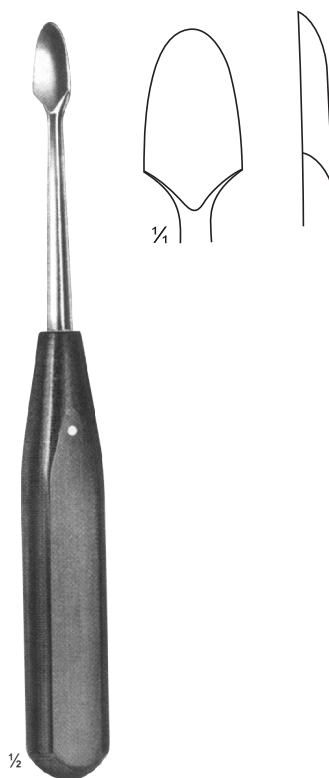

SS-19-191
200 mm
14 mm

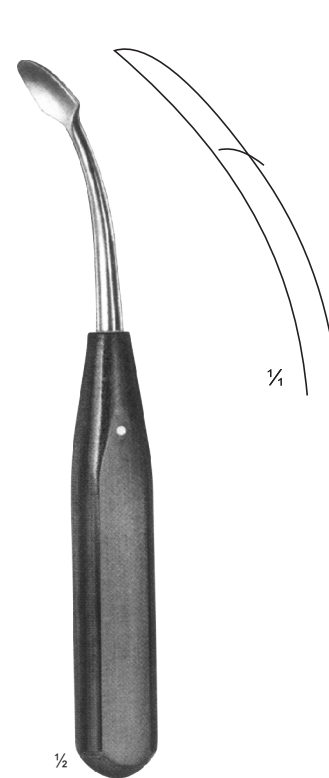

SS-19-192
190 mm
14 mm

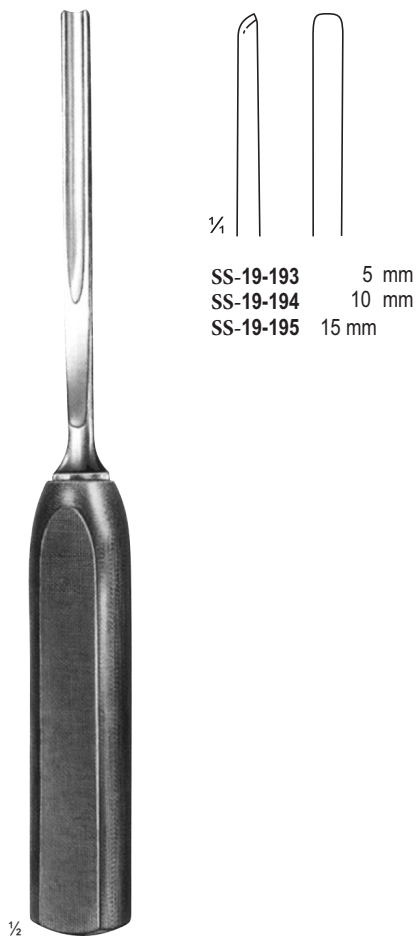

LEXER
SS-19-193 -
SS-19-195 245 mm

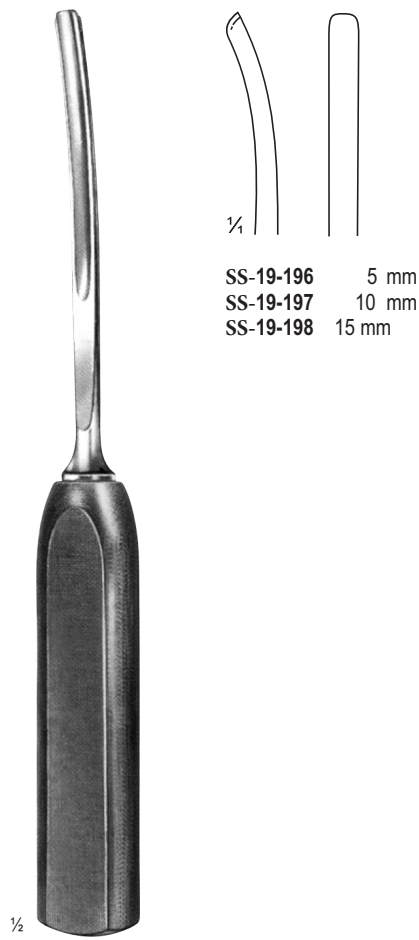

LEXER
SS-19-196 -
SS-19-198 245 mm

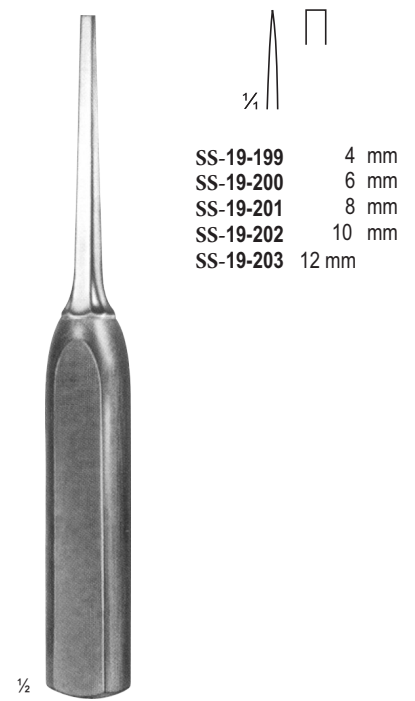

LEXER-MINI
SS-19-199 -
SS-19-203 180 mm



SS-19-204 10 mm
SS-19-205 15 mm

LEXER
SS-19-204 -
SS-19-205 Gouges,
angled
275 mm

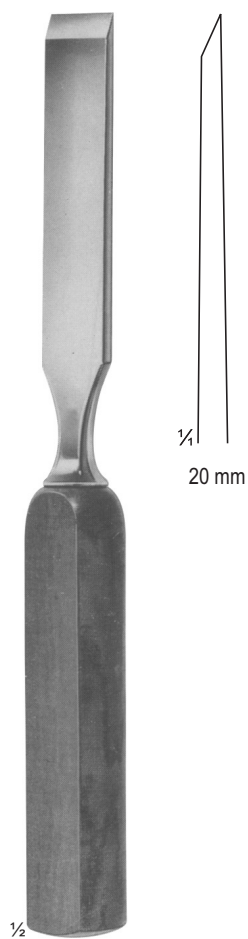

Chisel
SS-19-206
245 mm

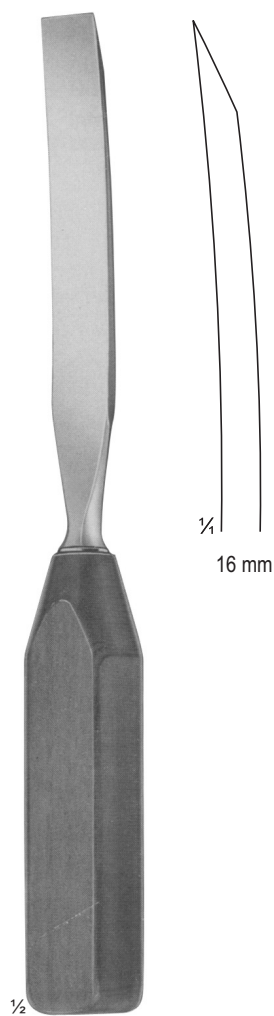

Chisel
curved
SS-19-207
265 mm

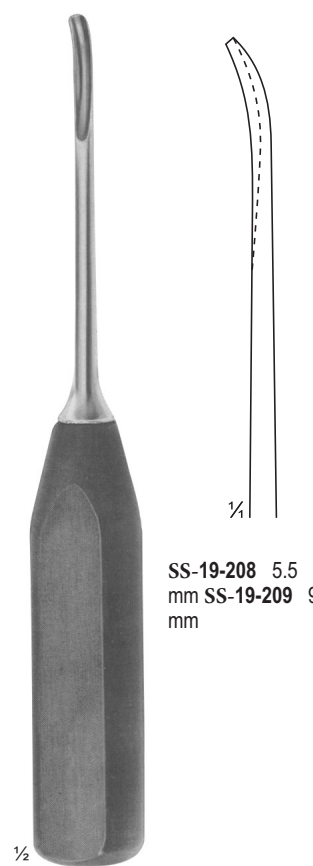

SS-19-208 5.5 mm
SS-19-209 9 mm

ZIELKE
SS-19-208 -
SS-19-209 Gouge for
scoliose-operations
230 mm



SS-19-210 -
SS-19-213 270 mm

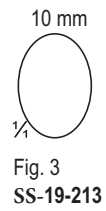
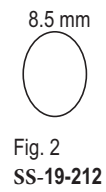
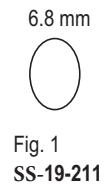
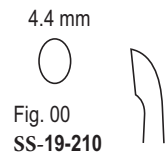

SYPERT
SS-19-214 -
SS-19-221380 mm

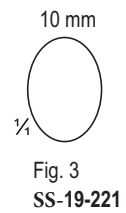
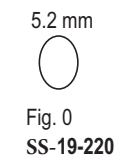
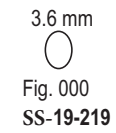
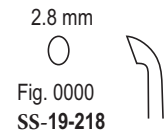
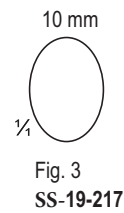
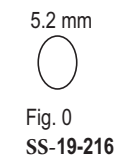
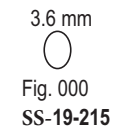
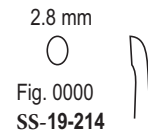



LANGENBECK
SS-19-222 -
SS-19-223



SS-19-222
200 mm



SS-19-223
200 mm



QUERVAIN
SS-19-224
200 mm

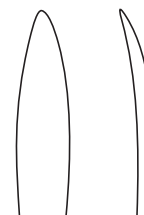

COBB
SS-19-225 -
SS-19-227



SS-19-225
28 cm



SS-19-226
280 mm



SS-19-227
280 mm



SS-19-228 - SS-19-233
SS-19-228 170 mm
SS-19-229 170 mm
SS-19-230 170 mm
SS-19-231 170 mm
SS-19-232 190 mm
SS-19-233 190 mm

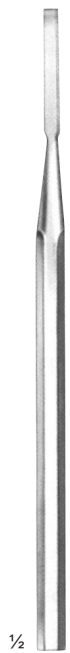

HOKE
 SS-19-234 -
 SS-19-238 170 mm



- SS-19-234
3 mm
- SS-19-235
5 mm
- SS-19-236
6 mm
- SS-19-237
8 mm
- SS-19-238
9 mm



HIBBS
 SS-19-239 -
 SS-19-243 245 mm

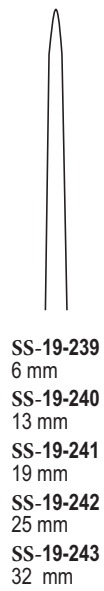

- SS-19-239
6 mm
- SS-19-240
13 mm
- SS-19-241
19 mm
- SS-19-242
25 mm
- SS-19-243
32 mm



HIBBS
 SS-19-244 -
 SS-19-248 245 mm



- SS-19-244
6 mm
- SS-19-245
13 mm
- SS-19-246
19 mm
- SS-19-247
25 mm
- SS-19-248
32 mm



SMITH-PETERSEN
SS-19-249 -
SS-19-255 205 mm



- SS-19-249
6 mm
- SS-19-250
9 mm
- SS-19-251
13 mm
- SS-19-252
16 mm
- SS-19-253
19 mm
- SS-19-254
25 mm
- SS-19-255
32 mm



SMITH-PETERSEN
SS-19-256 -
SS-19-262 205 mm



- SS-19-256
6 mm
- SS-19-257
9 mm
- SS-19-258
13 mm
- SS-19-259
16 mm
- SS-19-260
19 mm
- SS-19-261
25 mm
- SS-19-262
32 mm



SMITH-PETERSEN
SS-19-263 -
SS-19-266 205 mm



- SS-19-263
9 mm
- SS-19-264
14 mm
- SS-19-265
19 mm
- SS-19-266
25 mm



SMITH-PETERSEN
SS-19-267 -
SS-19-270 205 mm



- SS-19-267
9 mm
- SS-19-268
14 mm
- SS-19-269
19 mm
- SS-19-270
25 mm

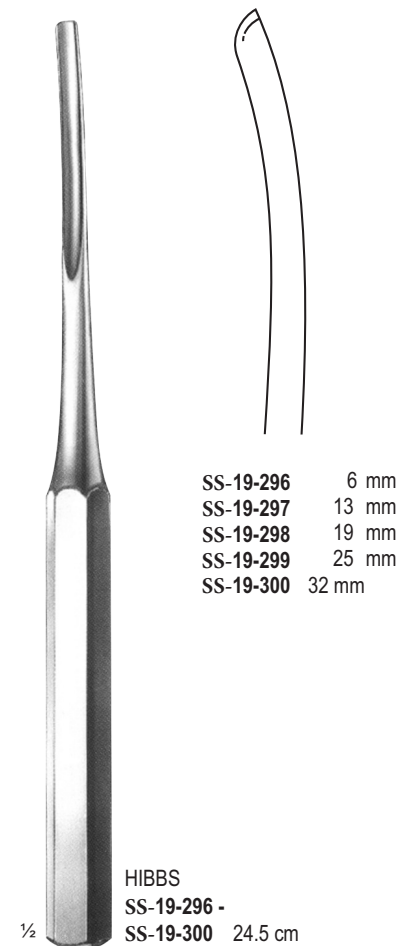
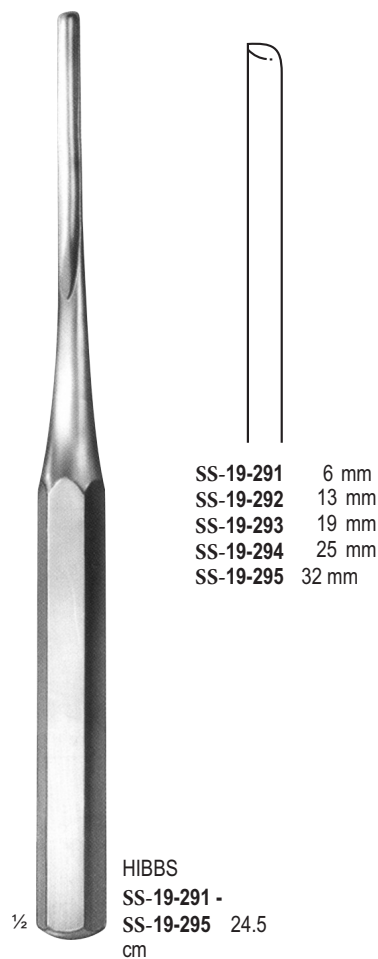
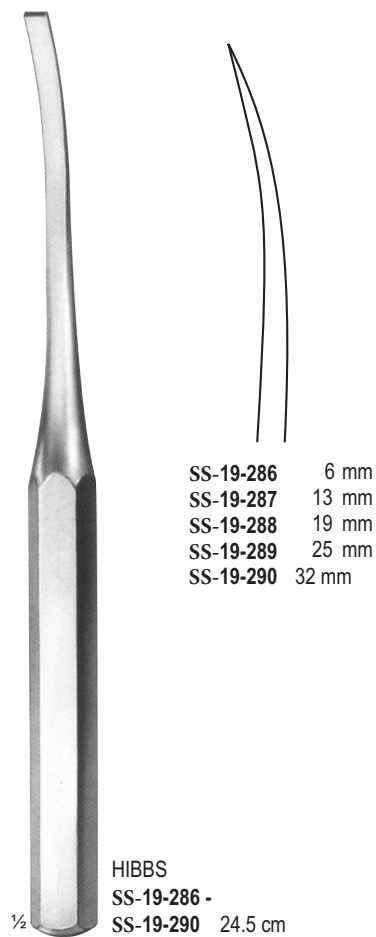
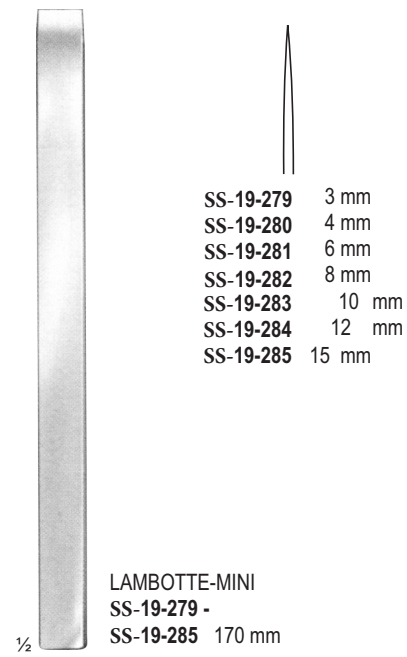
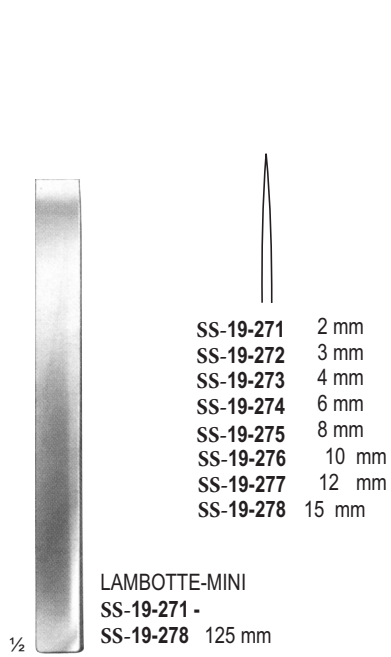

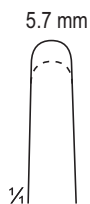

Haase
SS-19-301
100 mm



PASSOW
SS-19-302 -
SS-19-303 120 mm



FREER
Chisel
SS-19-304
160 mm



FREER
Chisel, curved
SS-19-305
160 mm

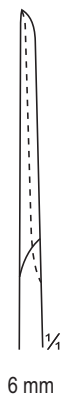

FREER
Gouge
SS-19-306
150 mm

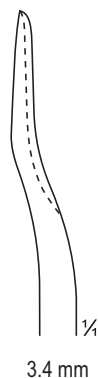

Scaphoid gouge,
downwards curved
SS-19-307
135 mm



Scaphoid gouge,
upwards curved
SS-19-308
135 mm



Mannerfelt
SS-19-309 - SS-19-311
SS-19-309 4 mm
SS-19-310 6 mm
SS-19-311 8 mm 155 mm

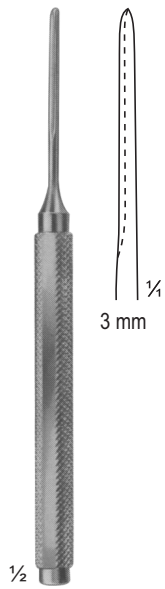

SS-19-312
Mannerfelt
155 mm

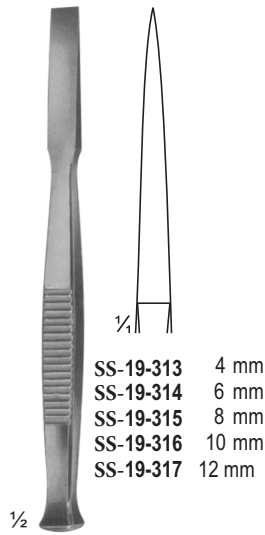

SS-19-313 -
SS-19-317 Osteotome
140 mm

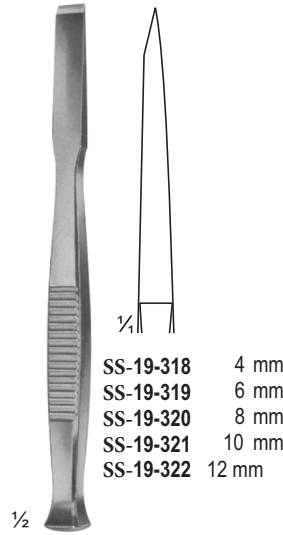

SS-19-318 -
SS-19-322 Chisels
140 mm

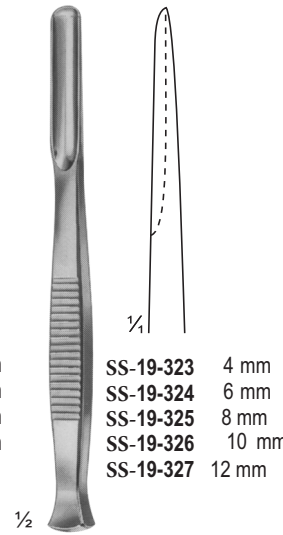

SS-19-323 -
SS-19-327 Gouges
140 mm

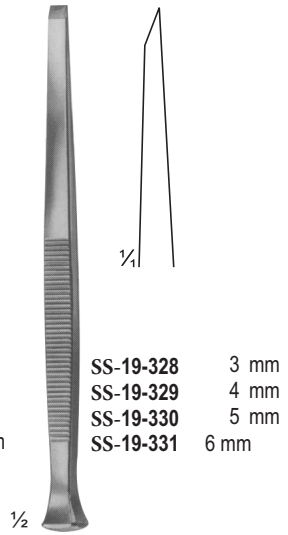

PARTSCH
SS-19-328 -
SS-19-331 CHISELS
140 mm

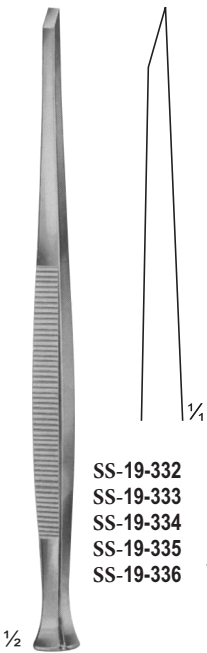

PARTSCH
SS-19-332 -
SS-19-336 Chisels
170 mm

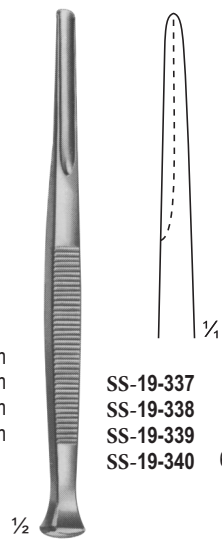

PARTSCH
SS-19-337 -
SS-19-340 Gouges
140 mm

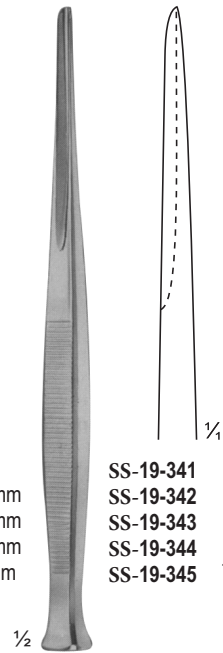

PARTSCH
SS-19-341 -
SS-19-345 Gouges
170 mm

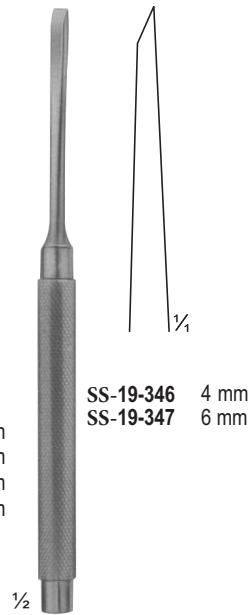

LUCAS
SS-19-346 -
SS-19-347 Chisels
160 mm

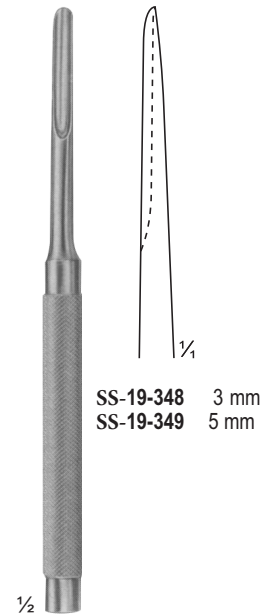

LUCAS
SS-19-348 -
SS-19-349 Gouges
160 mm

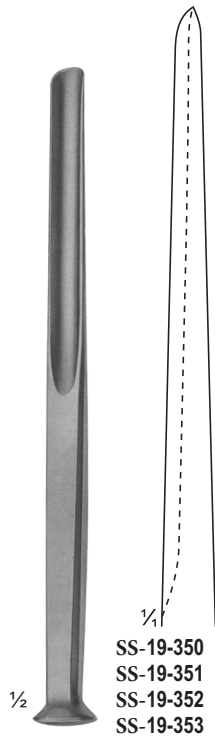

ALEXANDER
SS-19-350 -
SS-19-353 Gouges
170 mm

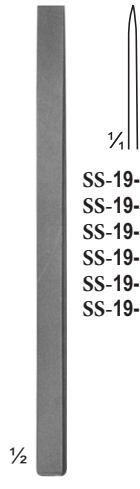

LAMBOTTE
SS-19-354 -
SS-19-359 Osteotome
125 mm

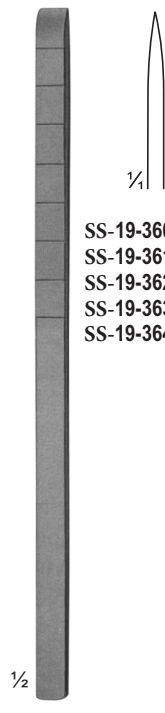

COTTLE
SS-19-360 -
SS-19-364 Osteotome
with depth markings
180 mm

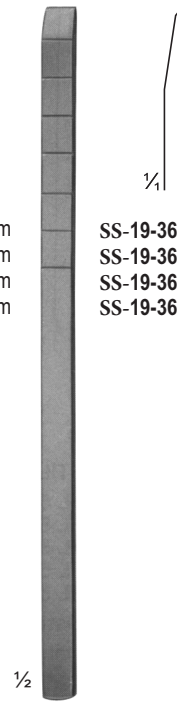

COTTLE
SS-19-365 -
SS-19-368 Chisel-
Osteotomes with depth
markings 180 mm



COTTLE
SS-19-369
Fishtail Chisel,
with protected ends
180 mm

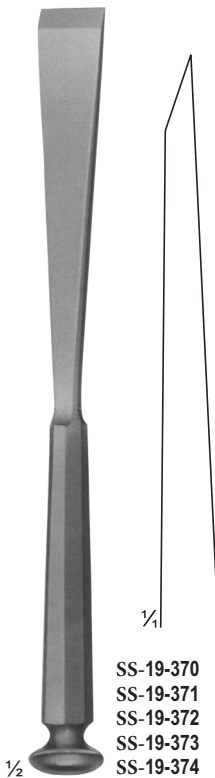

STILLE
SS-19-370 - SS-19-374
Chisels
205 mm

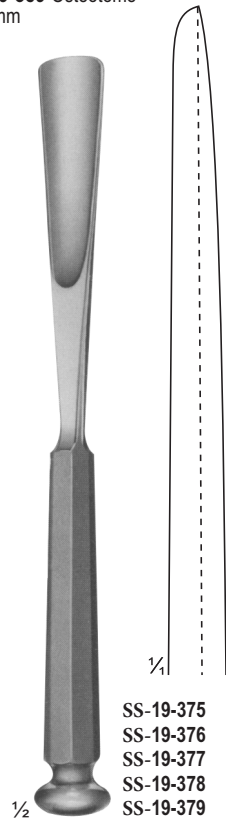

STILLE
SS-19-375 - SS-19-379
Gouges
205 mm

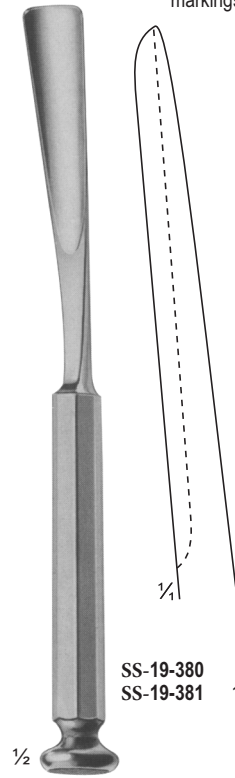

WALTER
SS-19-380 - SS-19-381
Osteotomes
gouges for taking grafts
from the rib 205 mm

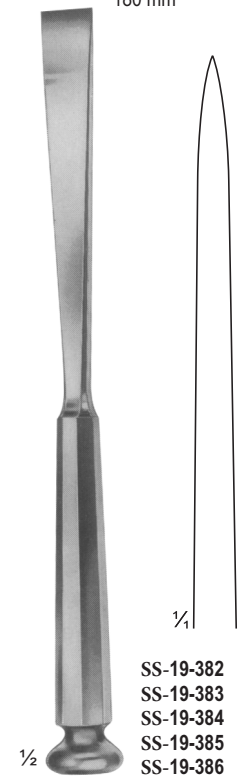

STILLE
SS-19-382 - SS-19-386
Osteotomes
205 mm

- SS-19-360 4 mm
- SS-19-361 6 mm
- SS-19-362 8 mm
- SS-19-363 10 mm
- SS-19-364 12 mm

- SS-19-365 4 mm
- SS-19-366 7 mm
- SS-19-367 9 mm
- SS-19-368 12 mm

- SS-19-354 4 mm
- SS-19-355 6 mm
- SS-19-356 8 mm
- SS-19-357 10 mm
- SS-19-358 12 mm
- SS-19-359 15 mm

- SS-19-350 5 mm
- SS-19-351 7 mm
- SS-19-352 9 mm
- SS-19-353 11 mm

- SS-19-370 10 mm
- SS-19-371 12 mm
- SS-19-372 15 mm
- SS-19-373 20 mm
- SS-19-374 25 mm

- SS-19-375 10 mm
- SS-19-376 12 mm
- SS-19-377 15 mm
- SS-19-378 20 mm
- SS-19-379 25 mm

- SS-19-380 10 mm
- SS-19-381 15 mm

- SS-19-382 8 mm
- SS-19-383 12 mm
- SS-19-384 15 mm
- SS-19-385 20 mm
- SS-19-386 25 mm

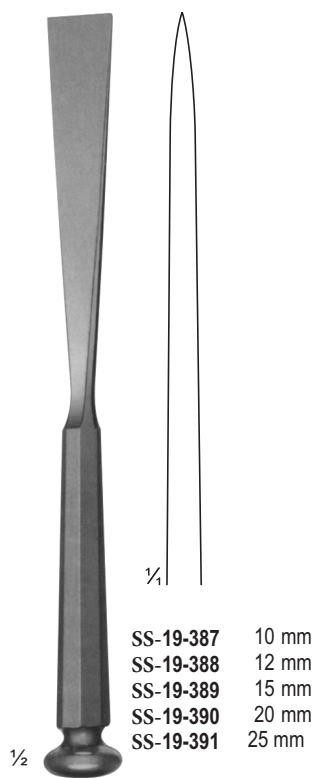

STILLE
SS-19-387 - SS-19-391
Osteotomes
205 mm

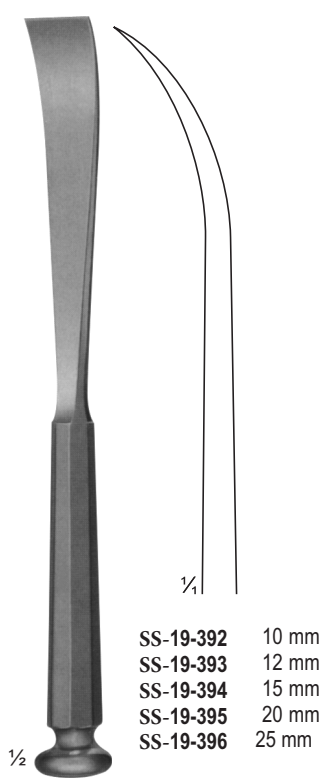

STILLE
SS-19-392 - SS-19-396
Osteotomes, curved 205
mm

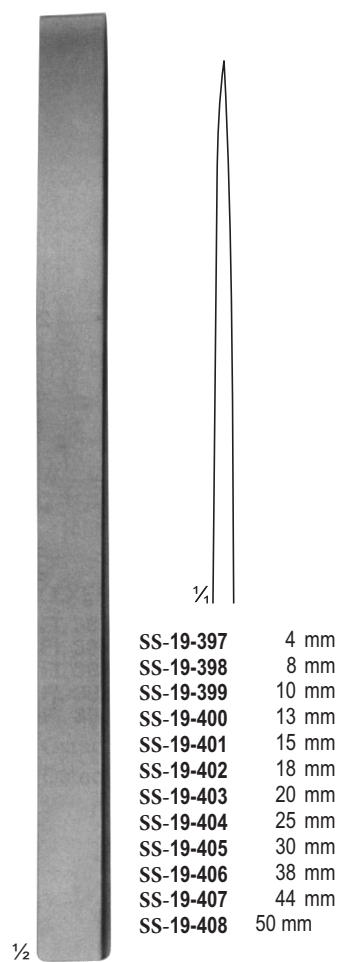

LAMBOTTE
SS-19-397 - SS-19-408
Osteotomes
245 mm

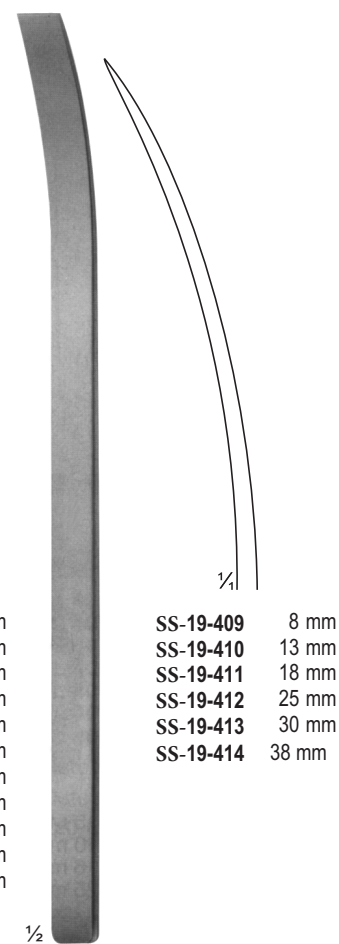

LAMBOTTE
SS-19-409 -
SS-19-414
Osteotomes, curved
245 mm



- SS-19-415 4 mm
- SS-19-416 6 mm
- SS-19-417 8 mm
- SS-19-418 10 mm
- SS-19-419 12 mm

1/2



- SS-19-420 4 mm
- SS-19-421 6 mm
- SS-19-422 8 mm
- SS-19-423 10 mm
- SS-19-424 12 mm

1/2

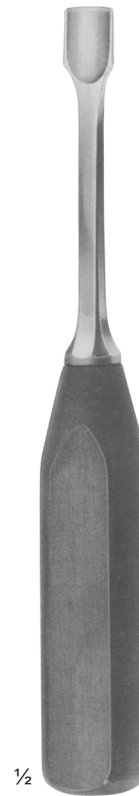

- SS-19-425 5 mm
- SS-19-426 7 mm
- SS-19-427 10 mm
- SS-19-428 15 mm
- SS-19-439 20 mm
- SS-19-430 25 mm
- SS-19-431 30 mm

1/2

LEXER-MINI
SS-19-415 - SS-19-419
Osteotomes
180 mm



- SS-19-432 5 mm
- SS-19-433 7 mm
- SS-19-434 10 mm
- SS-19-435 15 mm
- SS-19-436 20 mm
- SS-19-437 25 mm
- SS-19-438 30 mm

1/2

LEXER
SS-19-432 -
SS-19-438 Gouges
220 mm

LEXER-MINI
SS-19-420 - SS-19-424
Gouges
180 mm

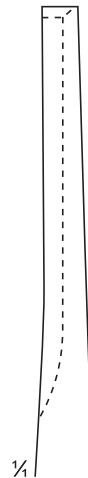

1/2

LEXER
SS-19-439
Gouge for
removing broken
screws
220 mm

LEXER
SS-19-425 - SS-19-431
Osteotomes
220 mm



- SS-19-440 5,5 mm
- SS-19-441 9,0 mm

1/2

ZIELKE
SS-19-440 - SS-19-441
Gouge for
scoliose-operations
230 mm

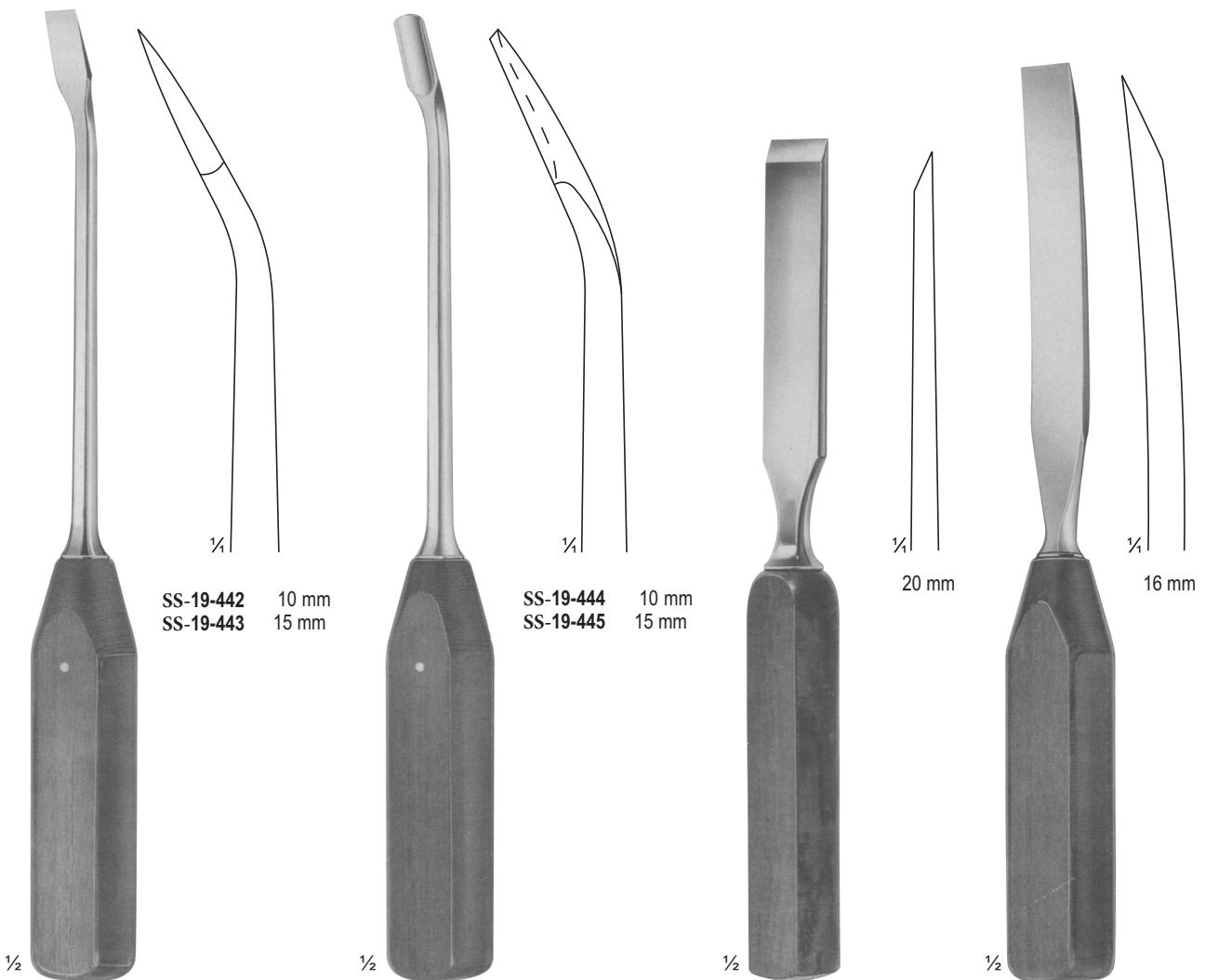

SS-19-442 10 mm
SS-19-443 15 mm

SS-19-444 10 mm
SS-19-445 15 mm

1/4
20 mm

1/4
16 mm

LEXER
SS-19-442 -
SS-19-443
Osteotomes, angled
275 mm

LEXER
SS-19-444 -
SS-19-445 Gouges,
angled
275 mm

SS-19-446
Chisel
245 mm

SS-19-447
Chisel, curved
265 mm

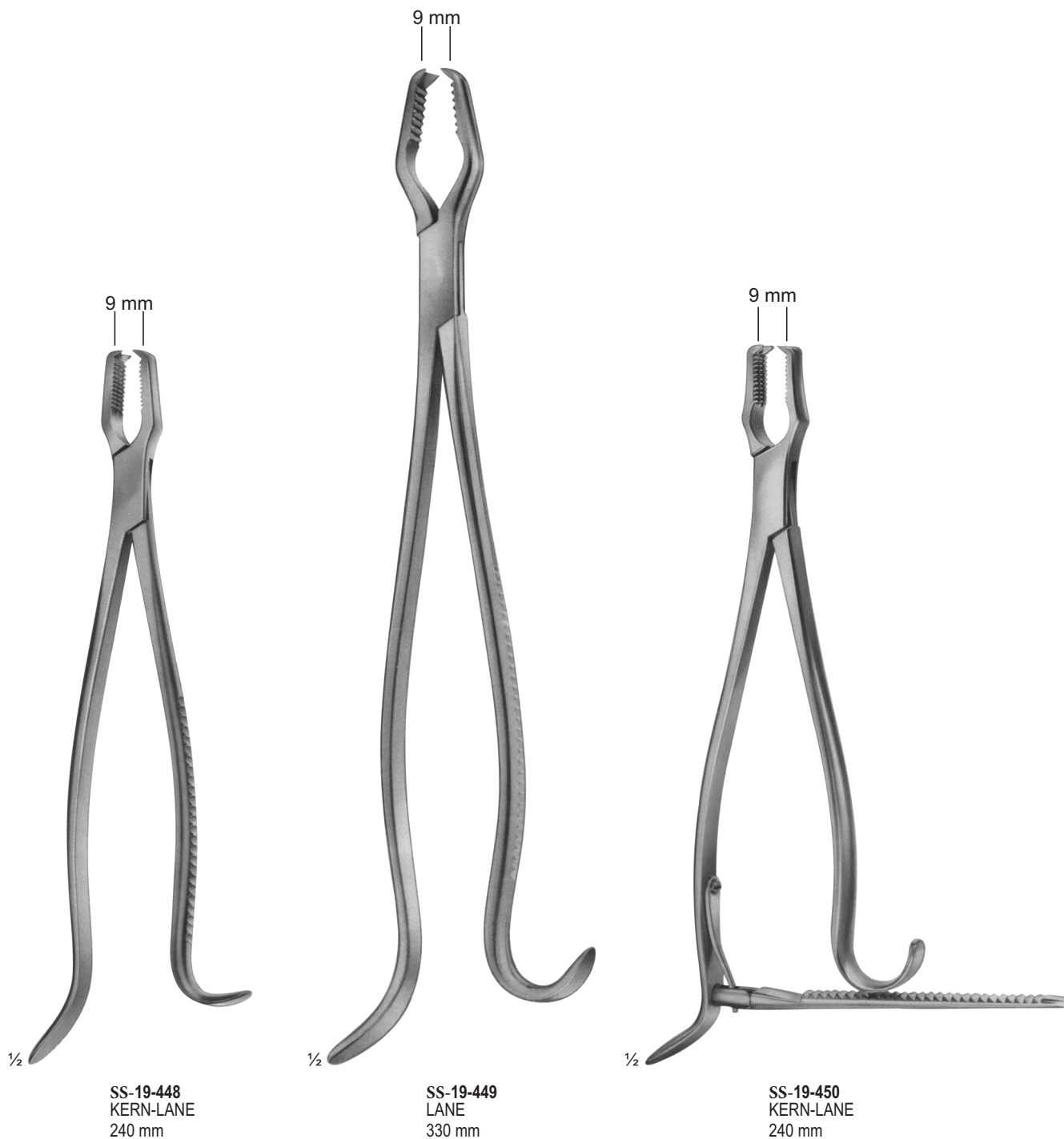



SS-19-451 - SS-19-455
 SS-19-451 145 mm
 SS-19-452 190 mm
 SS-19-453 240 mm
 SS-19-454 260 mm
 SS-19-455 280 mm



SS-19-451
 for small
 fragments

2.5 mm



SS-19-452
 Fig: 0

3.5 mm

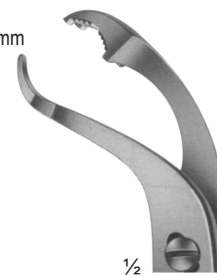

SS-19-453
 Fig: 1

11 mm
 3.5 mm



Self-centering forceps
 with thread fixation

SS-19-454
 Fig: 2

11.5 mm
 4.5 mm



SS-19-455
 Fig: 3



SS-19-456 -
 SS-19-458
 VERBRUGGE
 with lip joint

255 mm
 265 mm
 270 mm

4 mm



SS-19-456
 Fig: 1

10 mm

4.5 mm

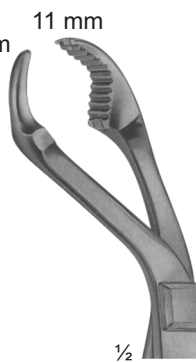

SS-19-457
 Fig: 2

11 mm

12 mm

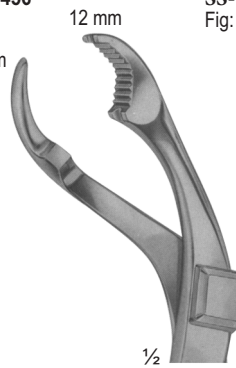

SS-19-458
 Fig: 3

4.5 mm

10 mm
 moveable jaw



adjustable jaw

SS-19-459
 LAMBOTTE
 265 mm

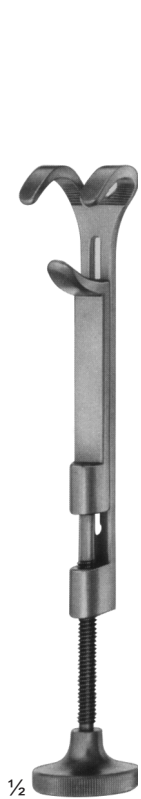

SS-19-460 -
SS-19-461
LOWMAN
SS-19-460 170 mm
SS-19-461 205 mm



SS-19-462
LOWMAN-GERSTER
210 mm



SS-19-463
LOWMAN-HOGLUND
175 mm

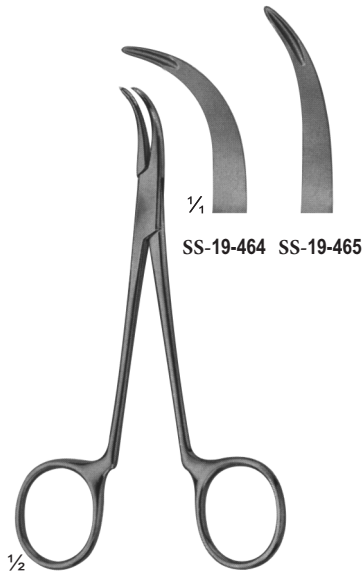

**SS-19-464 -
SS-19-465**
Synovectomy rongeur
width of jaws 1.2 mm
130 mm

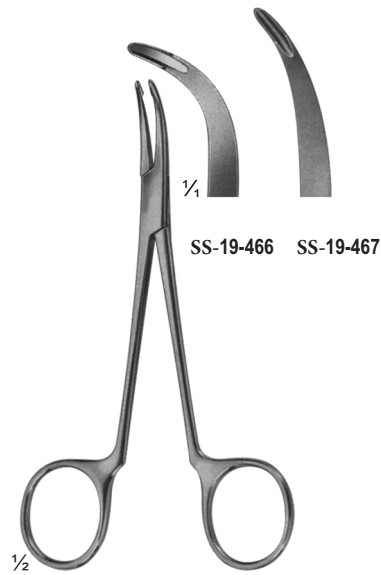

**SS-19-466 -
SS-19-467**
Synovectomy rongeur
width of jaws 2.0 mm
130 mm

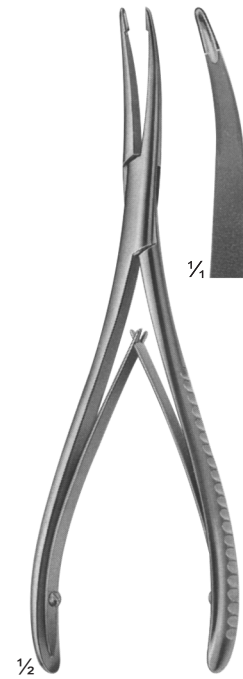

**SS-19-468
STELLBRINK**
Synovectomy rongeur
175 mm

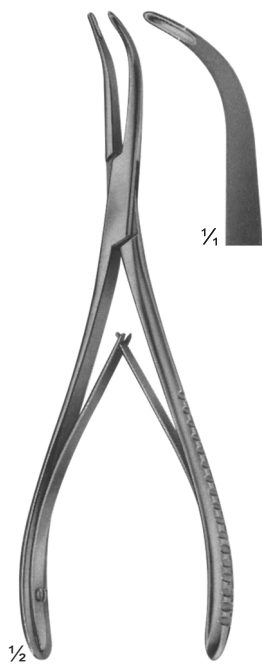

**SS-19-469
STELLBRINK**
Synovectomy rongeur
170 mm

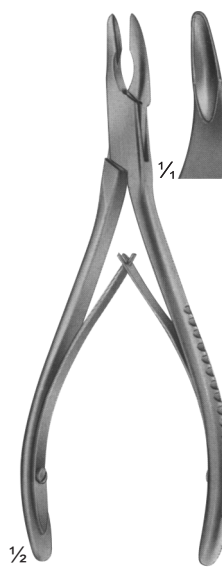

**SS-19-470 LURE-
FRIEDMANN** 145
mm

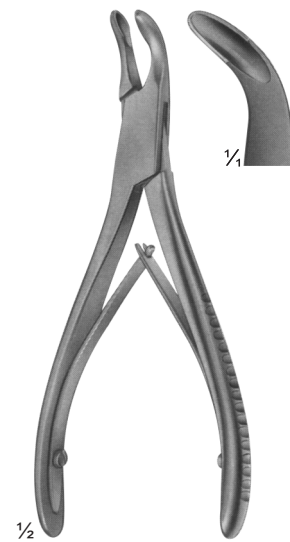

SS-19-471
140 mm



SS-19-472
LURE
150 mm

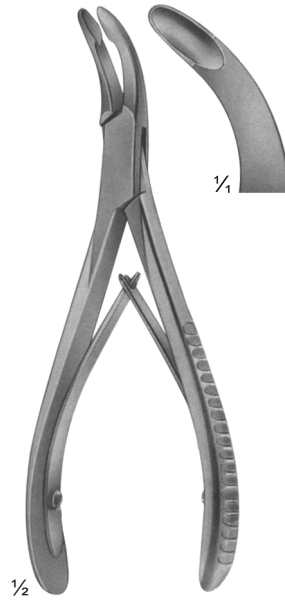

SS-19-473
LURE
155 mm

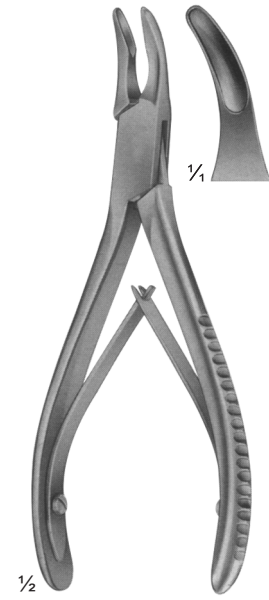

SS-19-474
BLUMENTHAL
155 mm

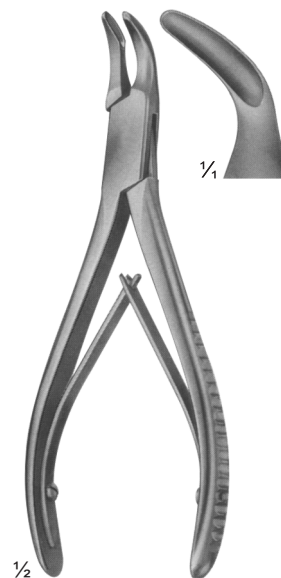

SS-19-475
BLUMENTHAL
150 mm

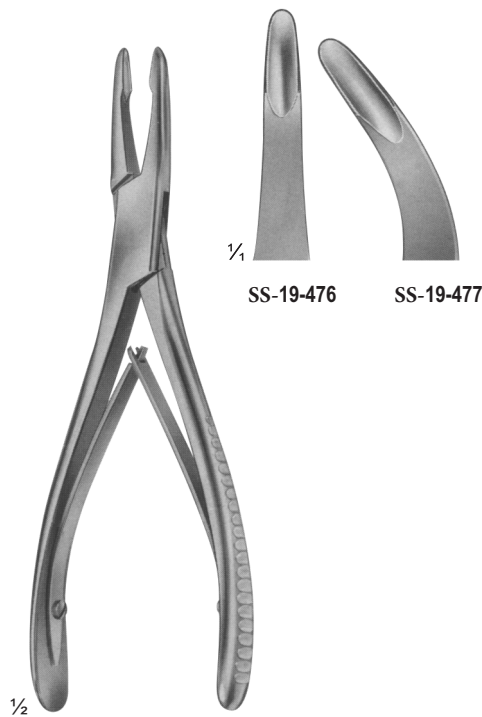

SS-19-476 - SS-19-477
JANSEN
175 mm

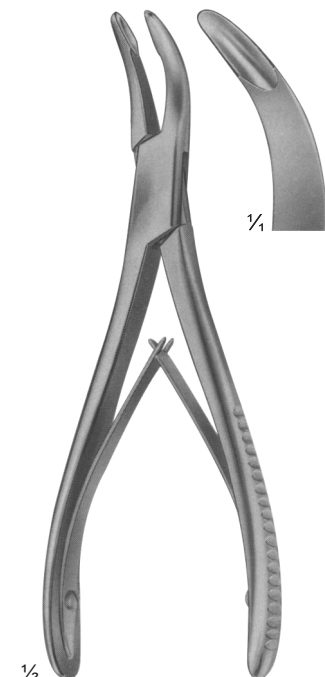

SS-19-478 BANE-
HARTMANN 175
mm

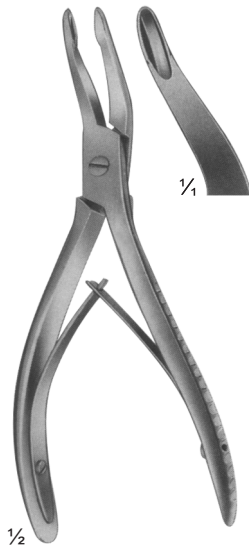

SS-19-479
ALEXANDER
140 mm

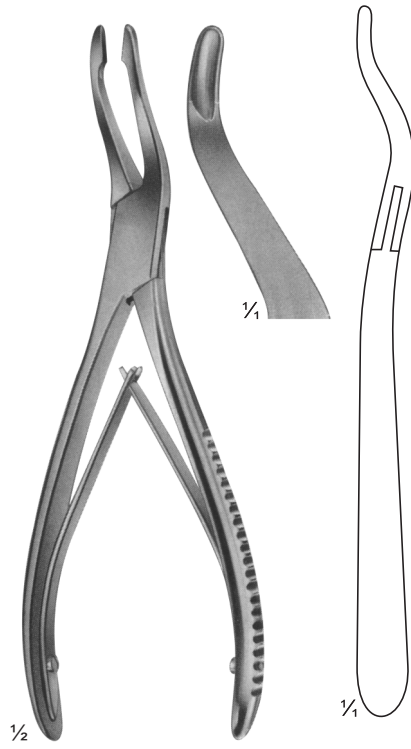

SS-19-480
JANSEN
190 mm

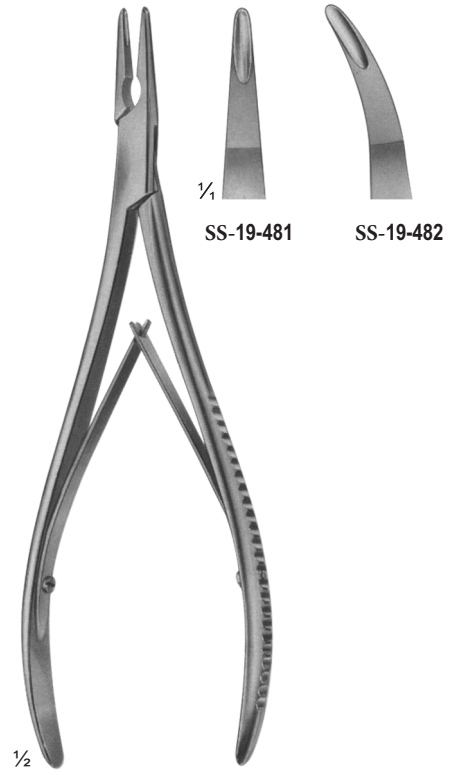

SS-19-481 -
SS-19-482 LEMPERT
200 mm

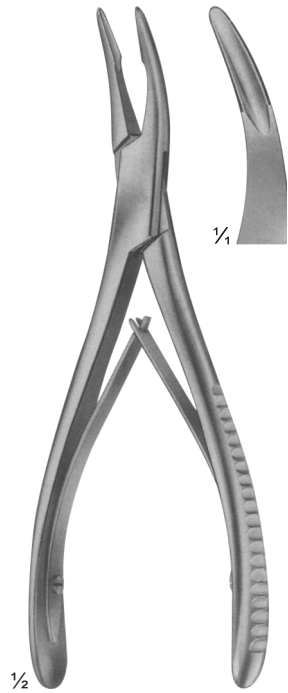

SS-19-483
BEYER
180 mm

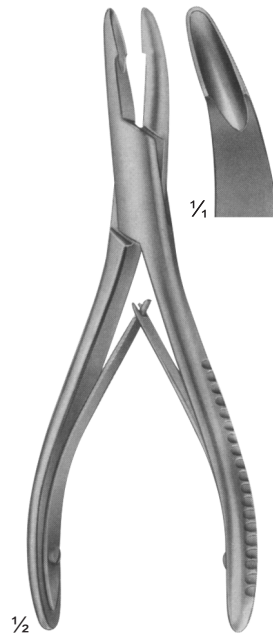

SS-19-484
MEAD
165 mm

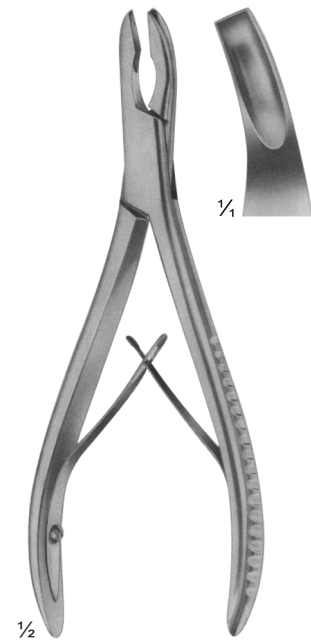

SS-19-485
MEAD
165 mm

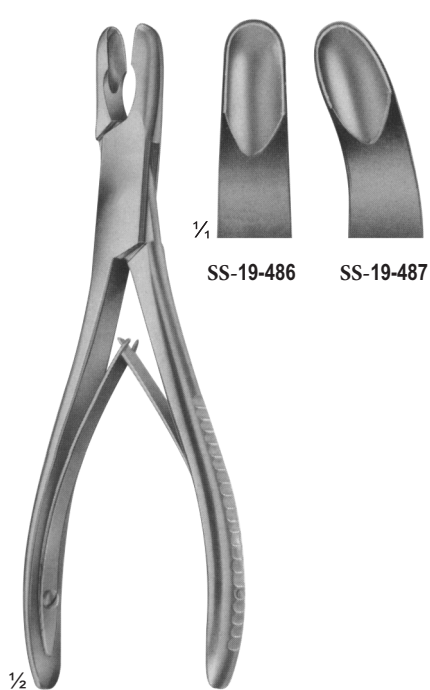

SS-19-486 -
SS-19-487 LURE
175 mm

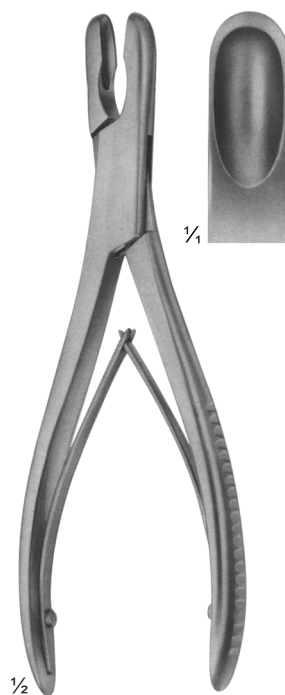

SS-19-488
LURE
180 mm

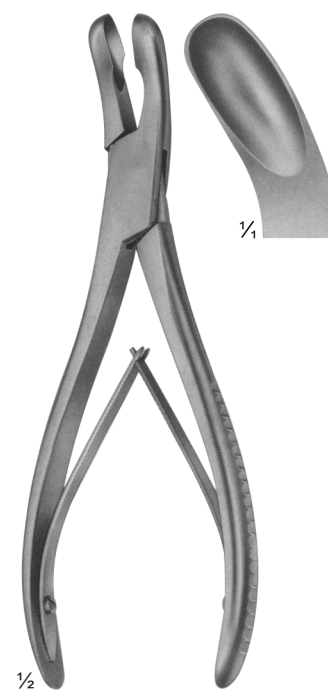

SS-19-499
LURE
180 mm

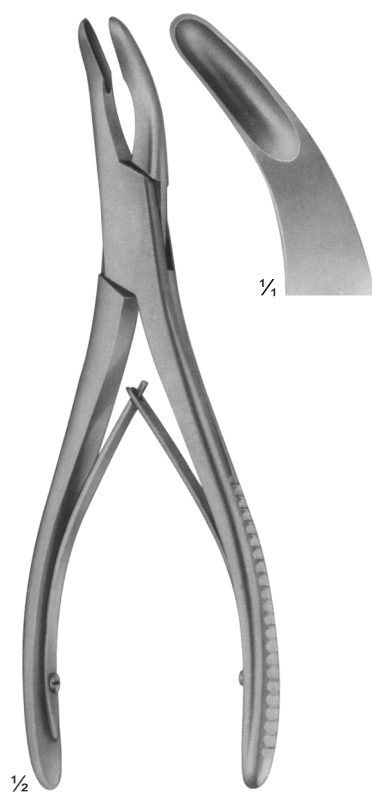

SS-19-490
OLIVECRONA
205 mm



SS-19-491 -
SS-19-492 BOHLER
155 mm

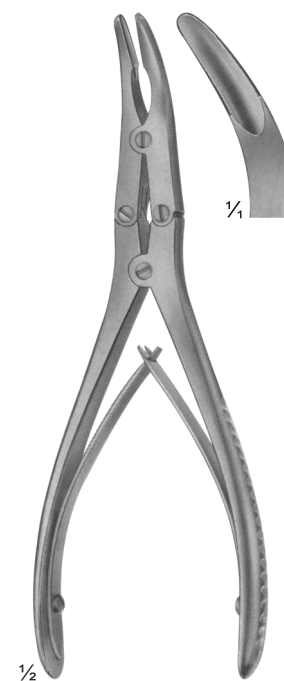

SS-19-493
MARQUARTD
200 mm

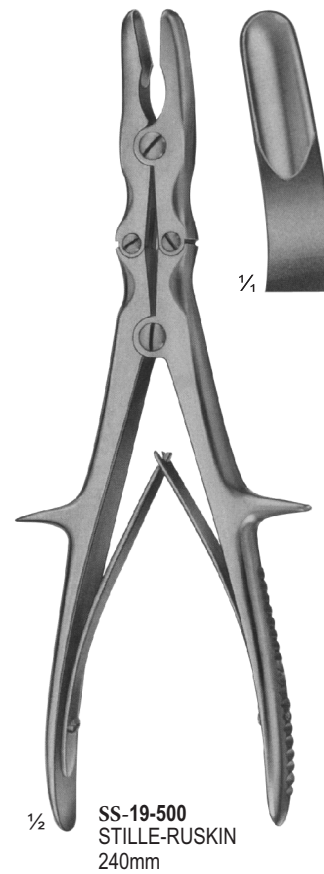
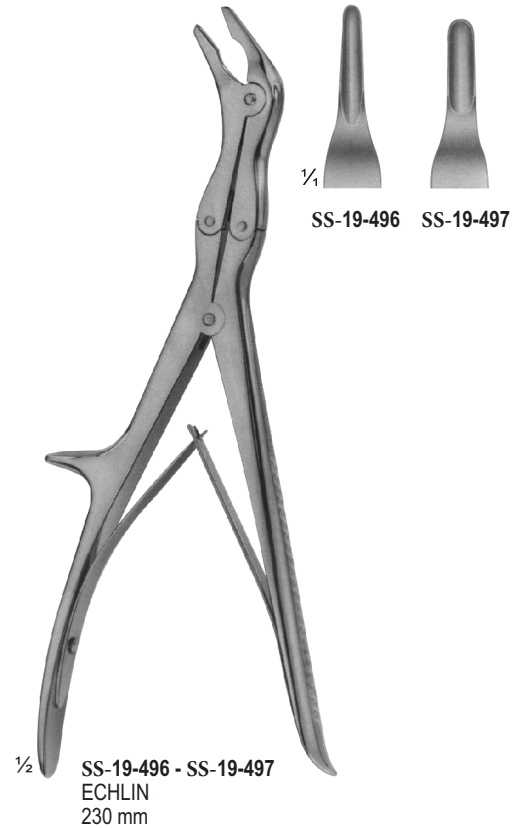
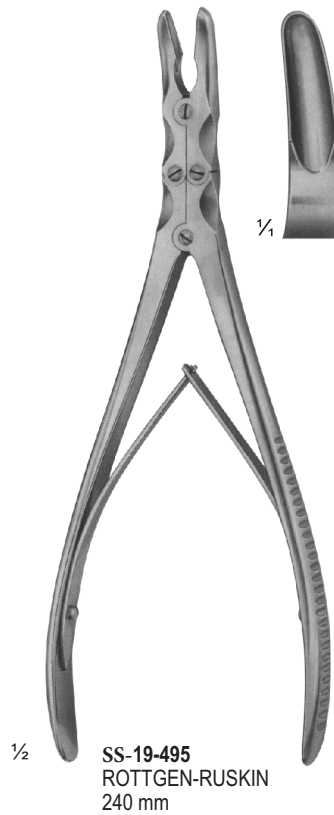

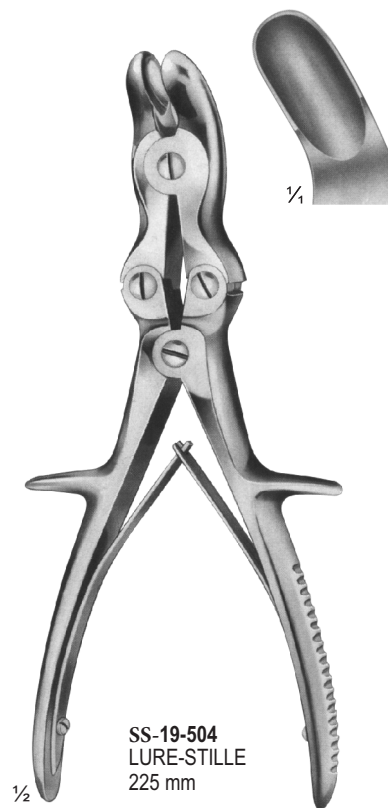
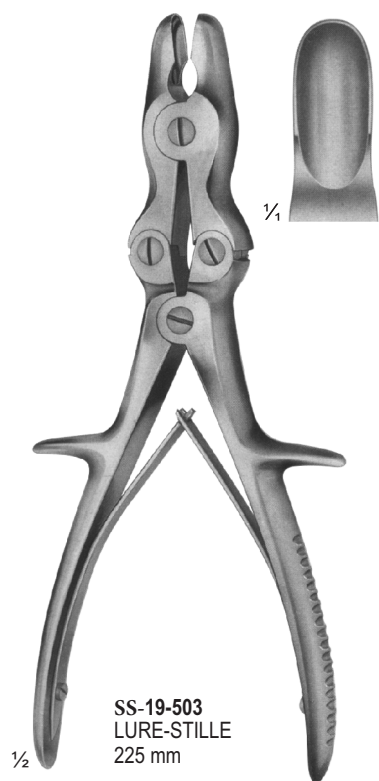
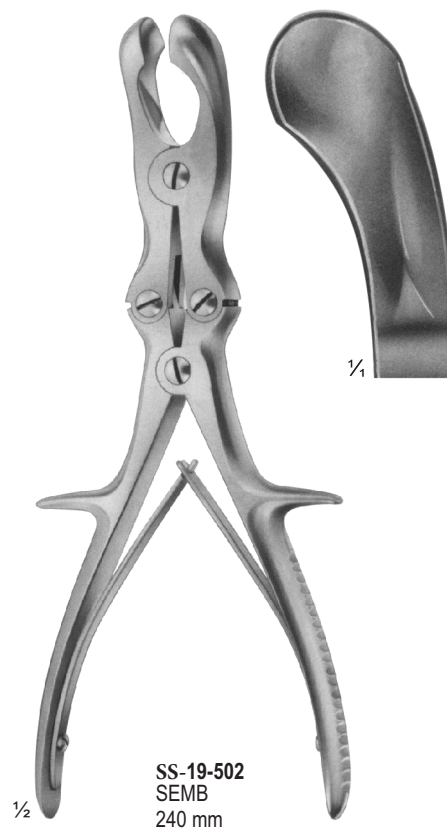
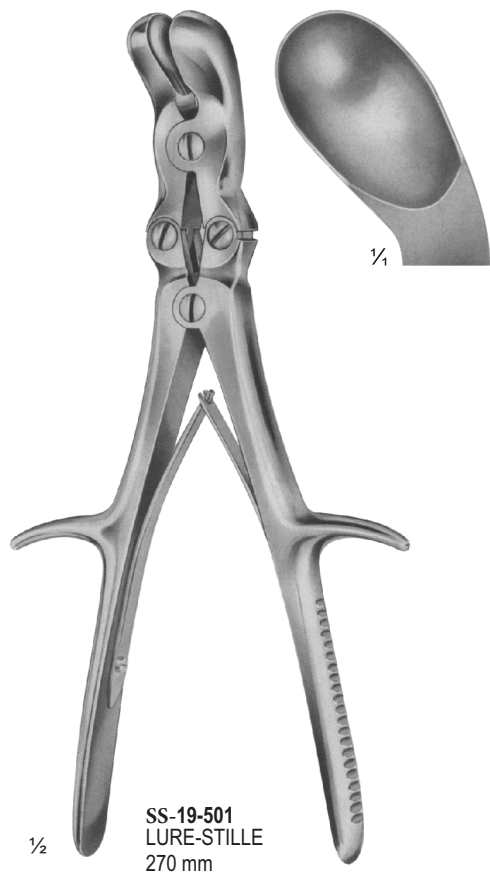

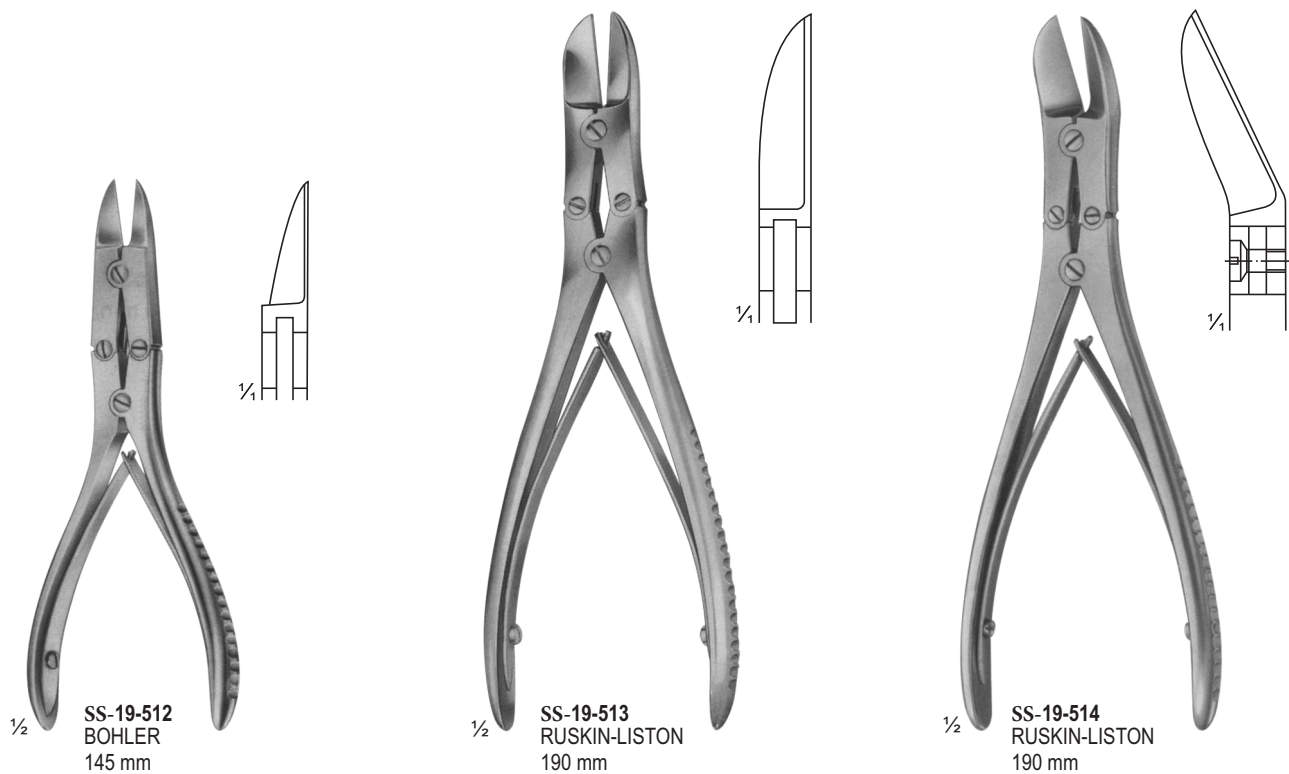
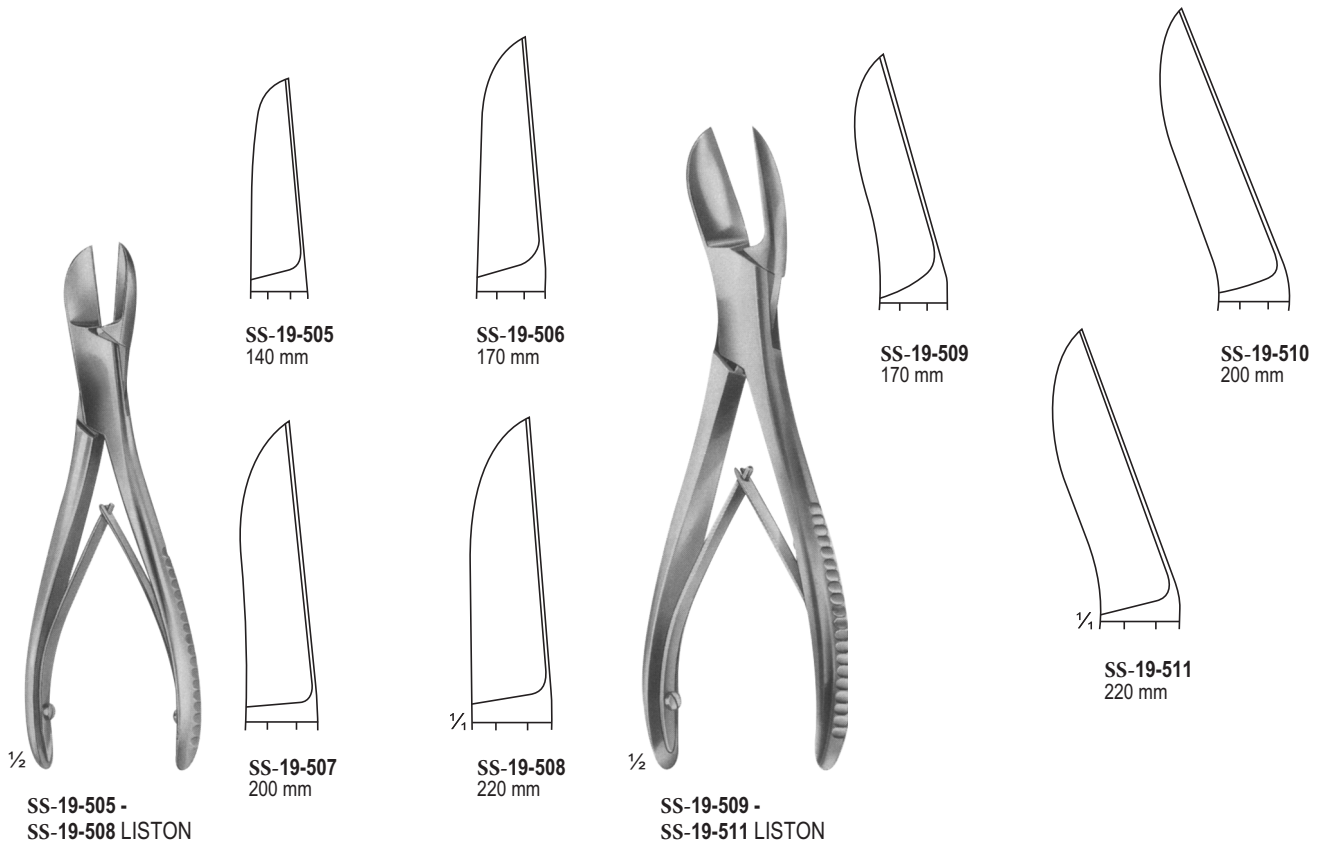

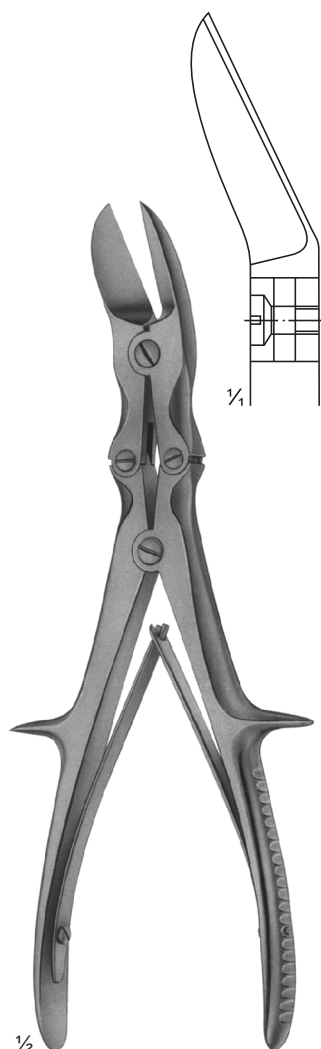

SS-19-515
LISTON
curved on flat
240 mm

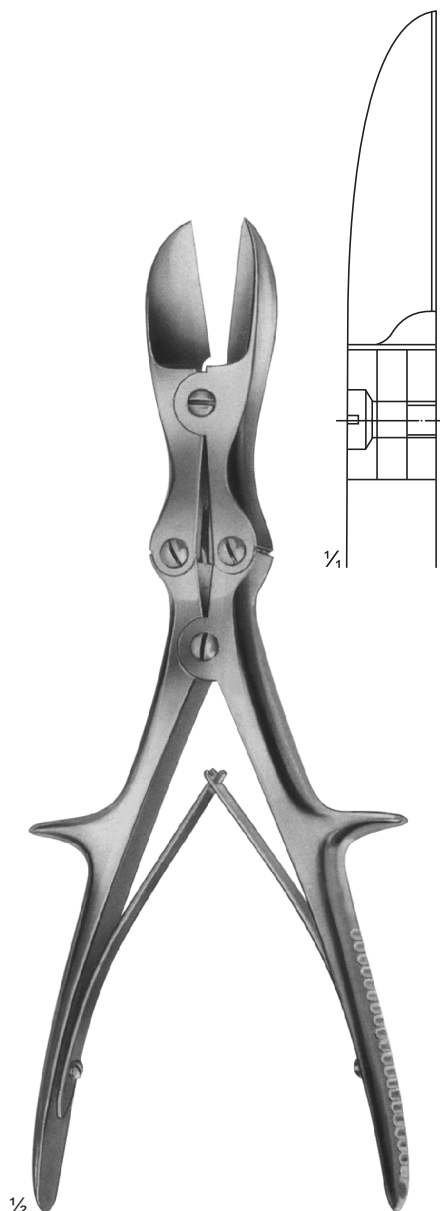

SS-19-516
LISTON
straight
280 mm

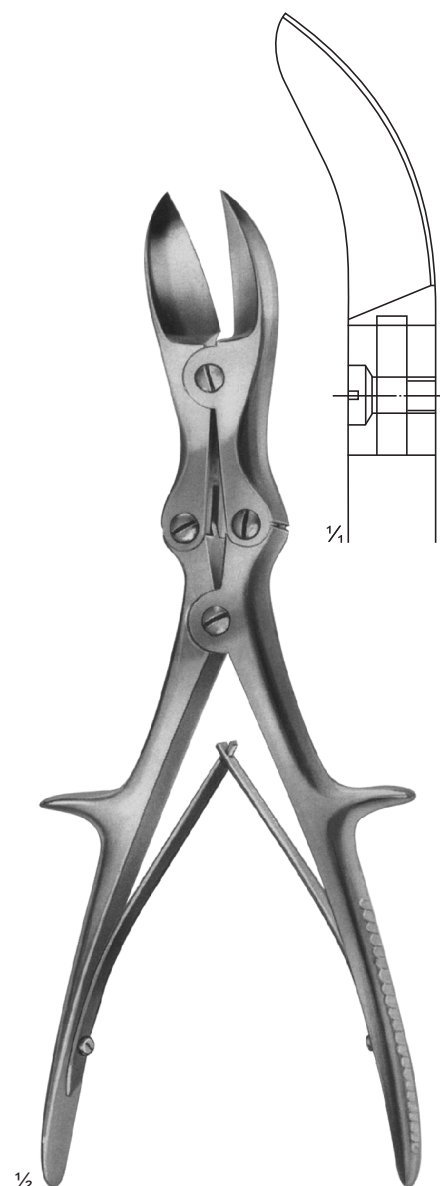

SS-19-517
LISTON
curved on flat
280 mm

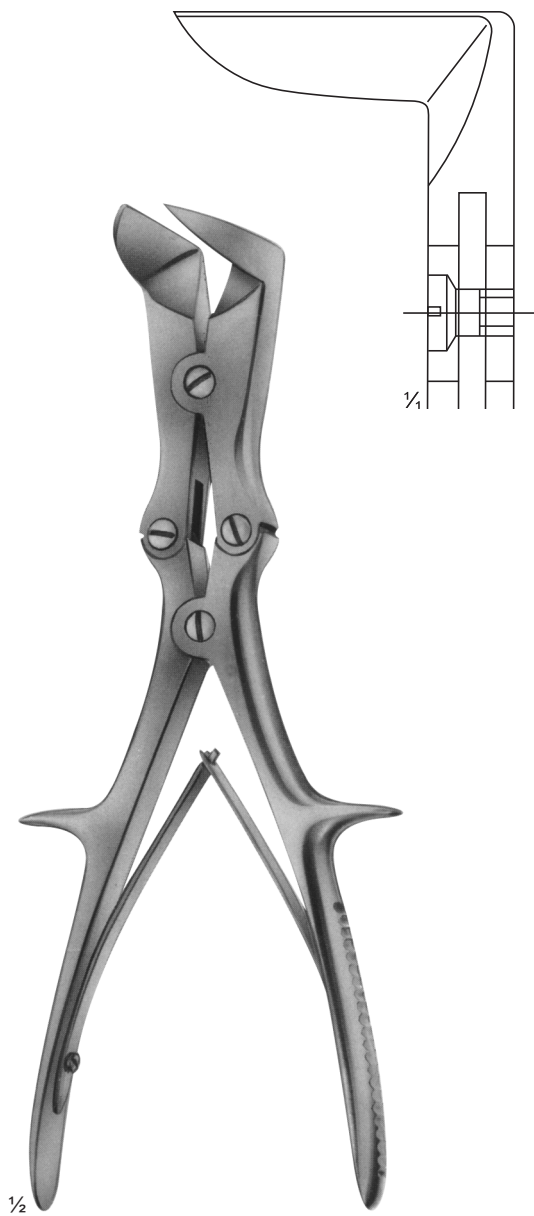

SS-19-518
LISTON-STILLE
265 mm

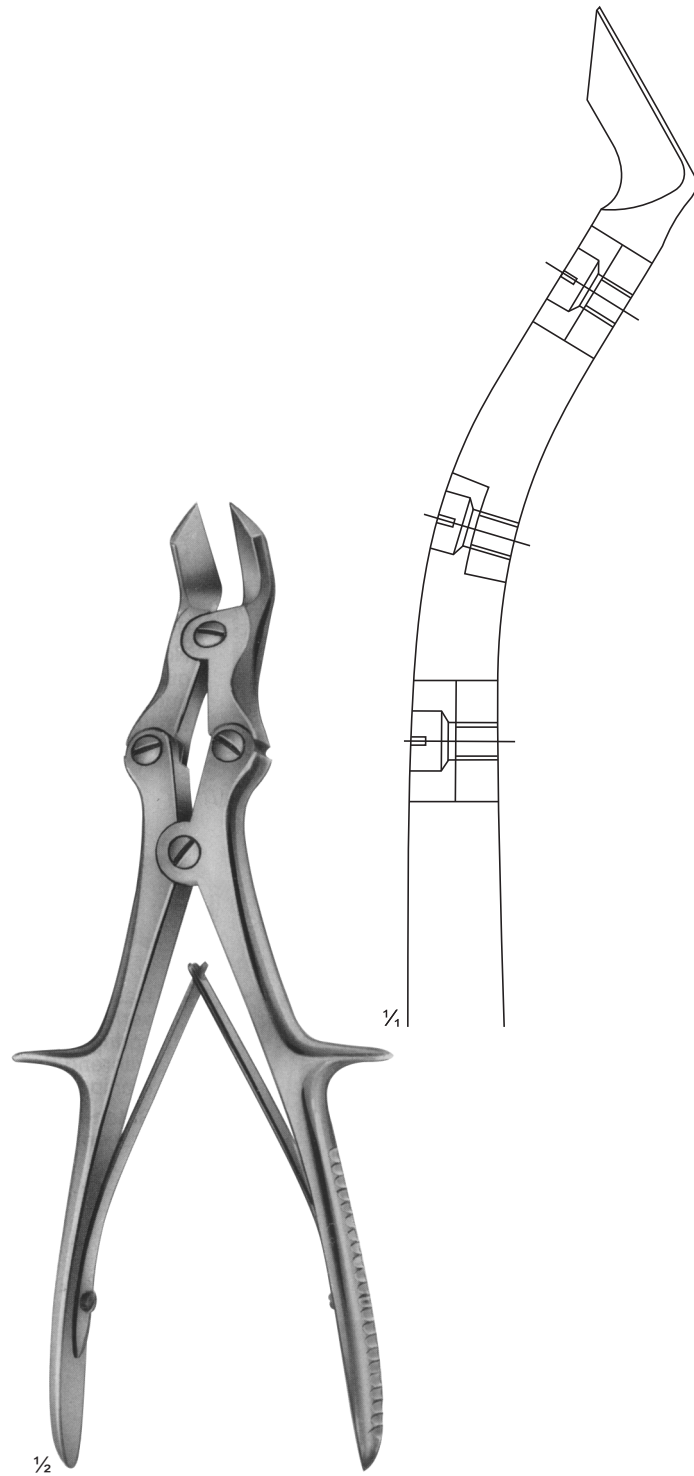

SS-19-519
LISTON-KEY-HORSLEY
(TUDOR EDWARDS)
255 mm

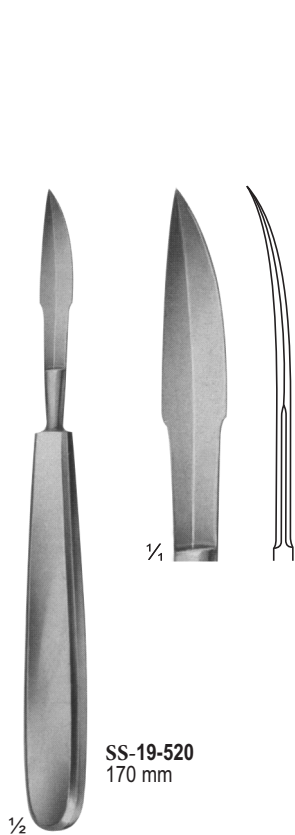

SS-19-520
170 mm

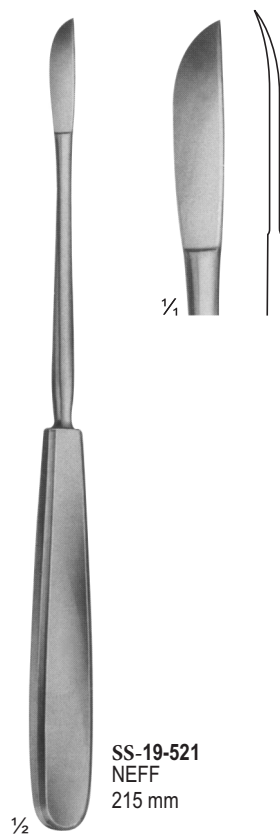

SS-19-521
NEFF
215 mm



SS-19-522
NEFF
215 mm

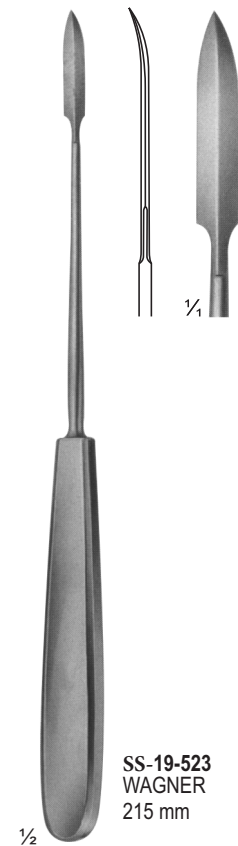

SS-19-523
WAGNER
215 mm

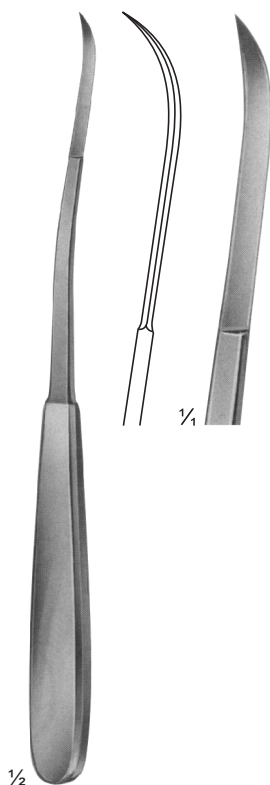

SS-19-524
SALENIUS
220 mm

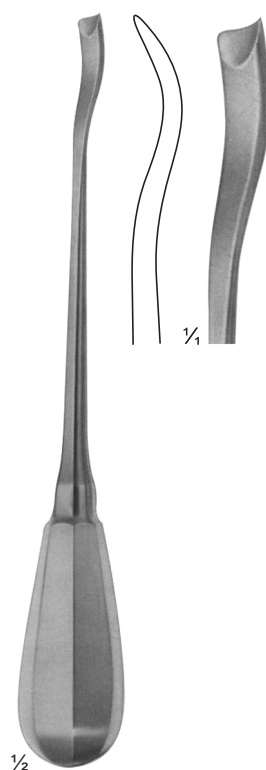

SS-19-525
CHNAD.MODELL
200 mm

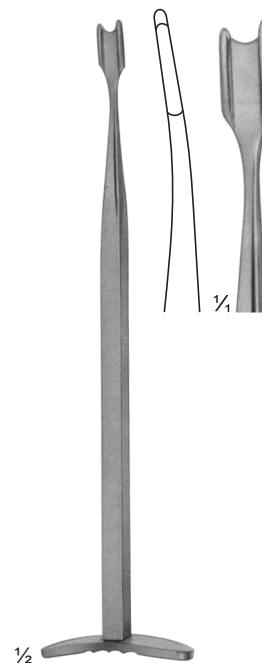

SS-19-526
SMILLIE
170 mm

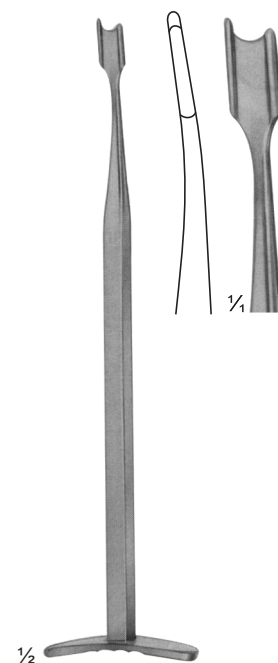

SS-19-527
SMILLIE
170 mm

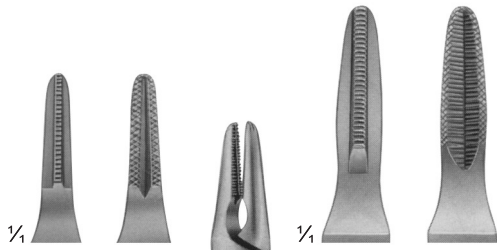

SS-19-528
130 mm

SS-19-529
180 mm



Extraction pliers
for boring
wires SS-19-528
SS-19-529



Flat-nosed pliers,
parallel
SS-19-530
185 mm

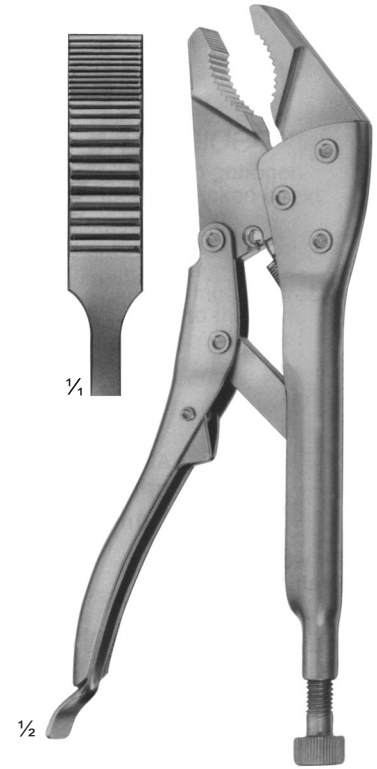
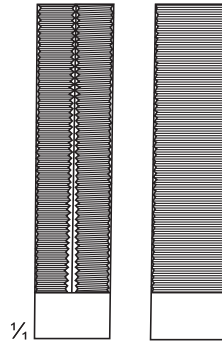

Vise grip
SS-19-531
200 mm

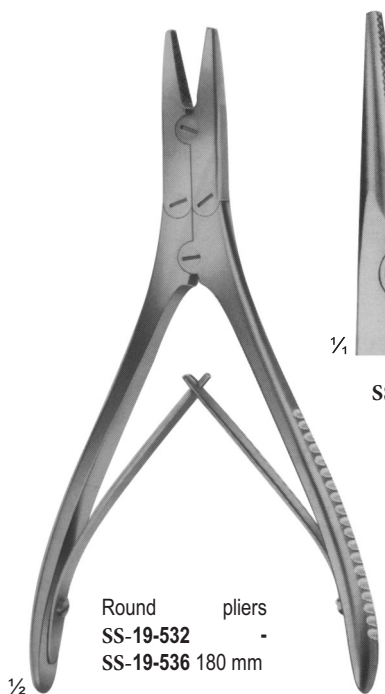

Round pliers
SS-19-532
SS-19-536 180 mm

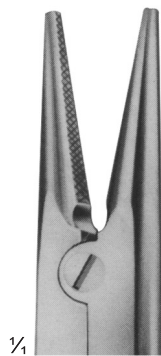

SS-19-532



SS-19-533



SS-19-534



SS-19-535



SS-19-536

SS-19-533
SS-19-534 14.5 cm
SS-19-535 18 cm
SS-19-536 18 cm
Extraction pliers for wires

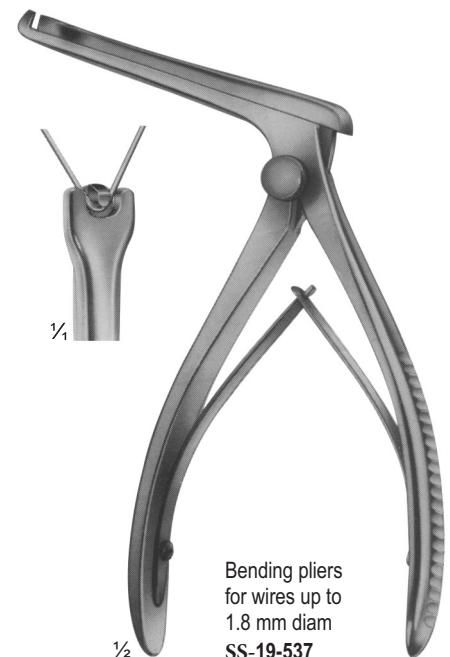

Bending pliers
for wires up to
1.8 mm diam
SS-19-537



BOHLER
SS-19-538
145 mm

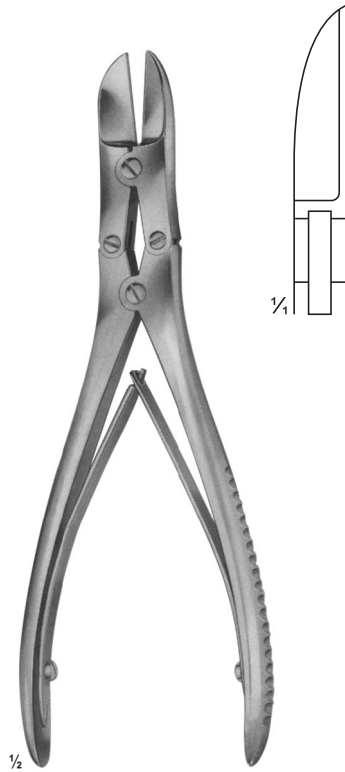

RUSKIN-LISTON
SS-19-539
190 mm

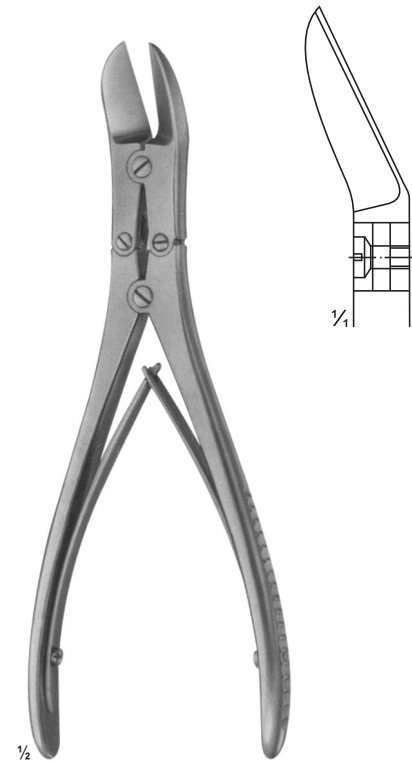

RUSKIN-LISTON
SS-19-540
190 mm

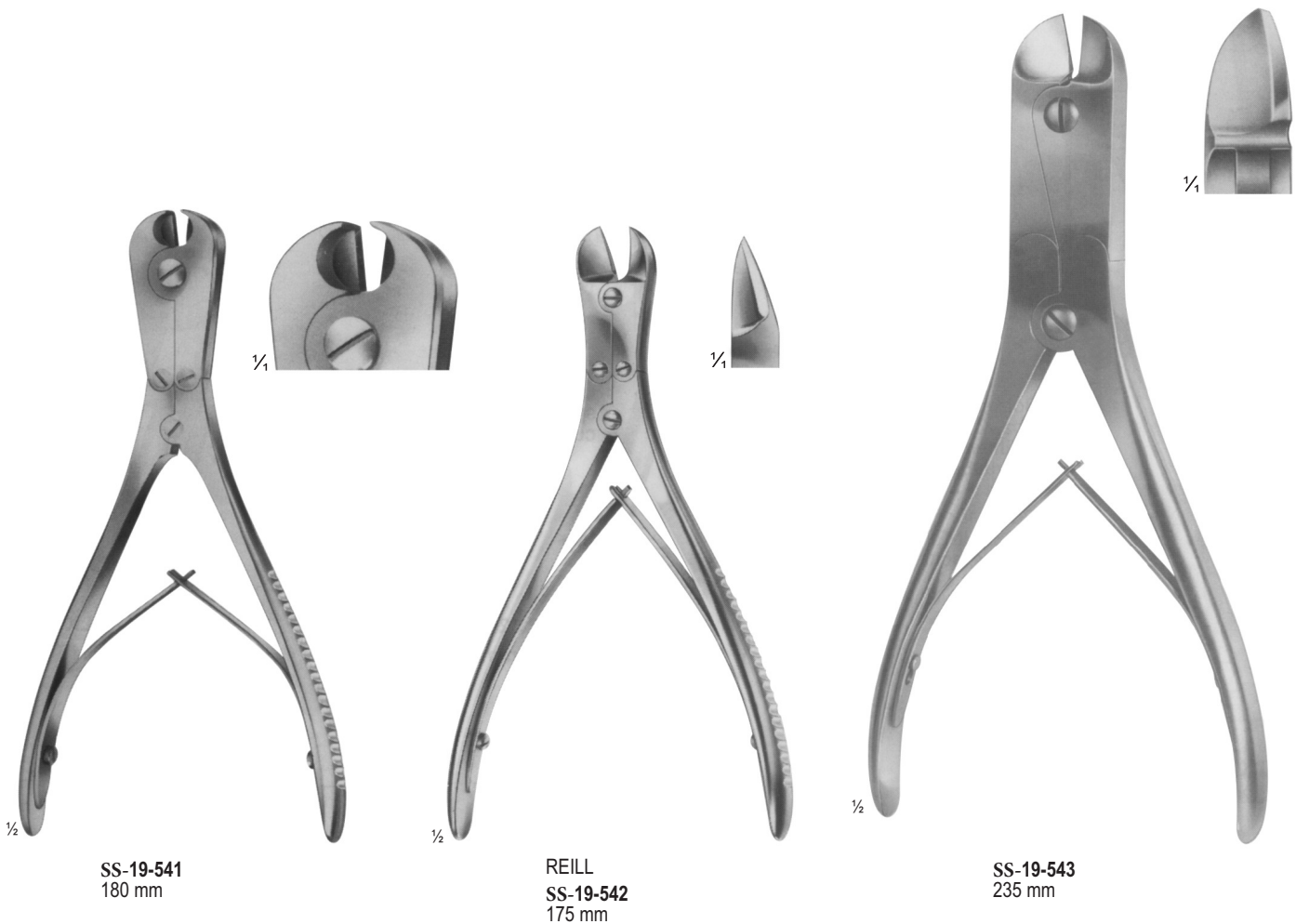

SS-19-541
180 mm

for soft wire
up to diam. 2,0 mm
For hard wire 1,5 mm
up to diam
specially hardened
cutting edges, front
and lateral cutting
action

REILL
SS-19-542
175 mm

for soft wire
up to diam. 2,0 mm
For hard wire 1,6 mm
up to diam
specially hardened
cutting edges, for
cutting off wires close
to the bone

SS-19-543
235 mm

for soft wire
up to diam. 3,0 mm
For hard wire 2,2 mm
up to diam

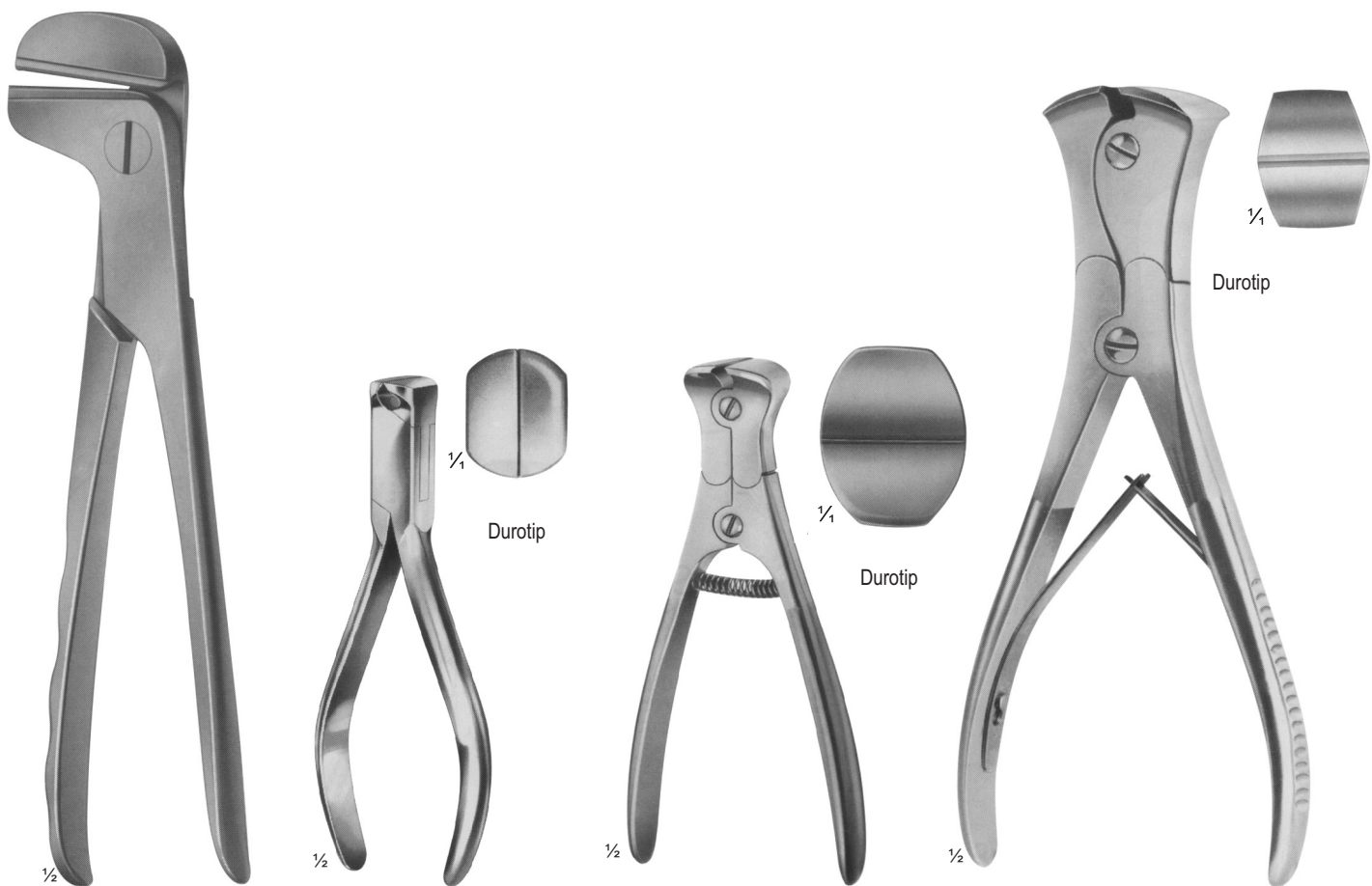

SS-19-544
240 mm

for soft wire
up to diam. 2 mm
For hard wire
up to diam. 1.6 mm

SS-19-545
140 mm

for soft wire
up to diam. 1.5 mm
For hard wire
up to diam. 1 mm

SS-19-546
145 mm

for soft wire
up to diam. 2 mm
For hard wire
up to diam. 1.5 mm

SS-19-547
220 mm

for soft wire
up to diam. 3.5 mm
For hard wire
up to diam. 2.5 mm



SS-19-548
320 mm

for soft wire
up to diam. 3 mm
For hard wire
up to diam 3 mm

Cutter for cutting off
KIRSCHNER wires,
Tibia head screws,
bolts, pins, up to 3 mm diam.



Durotip

SS-19-549
Cutter for cutting off
KIRSCHNER wires,
Tibia head screws,
bolts, pins, up to 6 mm diam.
470 mm

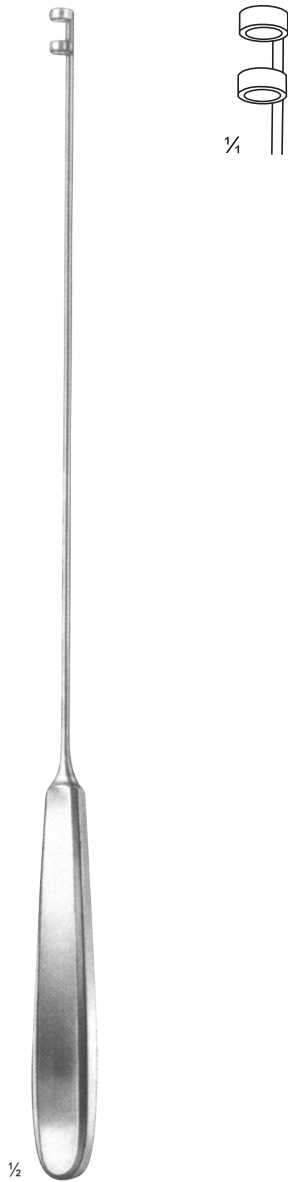

FISCHER
SS-19-550
310 mm
Blunt

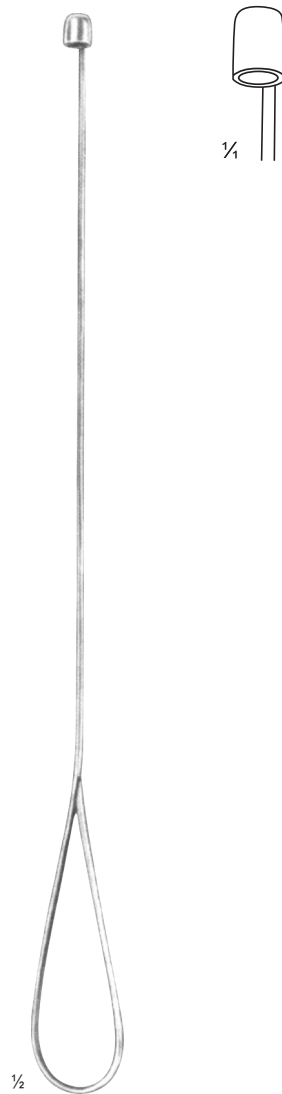

SS-19-551
285 mm

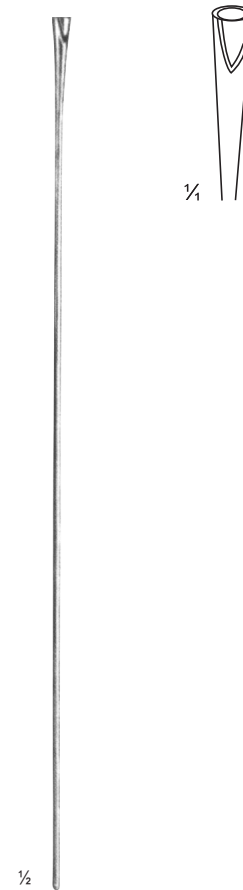

BUNNELL
SS-19-552
230 mm
Tendon Passer

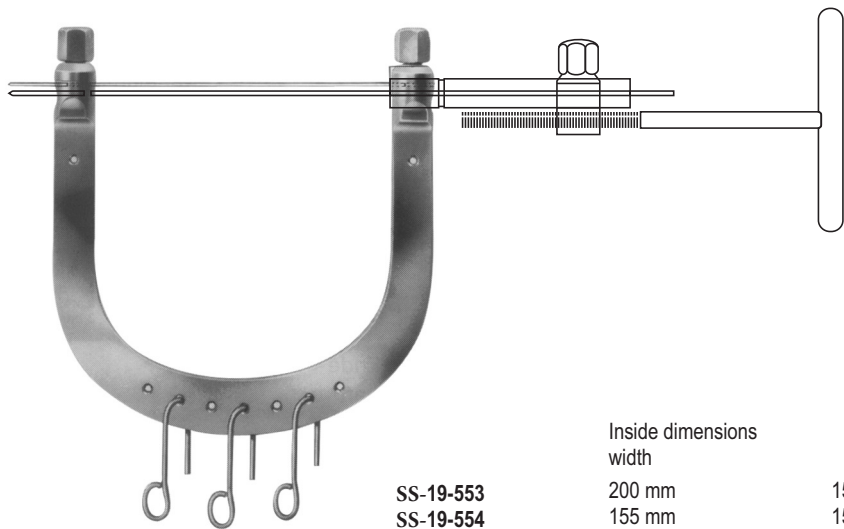

**KIRSCHNER
SS-19-553 - SS-19-559**
Wire traction bows, to be used with KIRSCHNER-wires up to 2.5 mm diam., With 3 hooks, stainless steel

SS-19-553
SS-19-554
SS-19-555
SS-19-556
SS-19-557
SS-19-558
SS-19-559

Inside dimensions
width

200 mm
155 mm
135 mm
120 mm
105 mm
95 mm
95 mm

Depth

155 mm
155 mm
130 mm
120 mm
100 mm
110 mm
70 mm



SS-19-560
Wrench, double - ended,
for wire traction bows

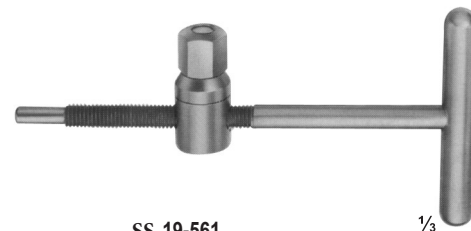

SS-19-561
Wire tightener, with
clamping jaws



1/3

SS-19-562
Traction hook only,
large size



1/3

SS-19-563
Traction hook only,
small size



1/3

SS-19-564
Fixation clamp, to secure clamping
jaws of stainless steel

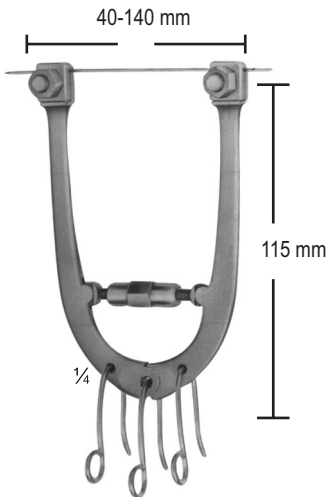

SS-19-565
Wire traction bow, adjustable,
with 3 hooks, small size

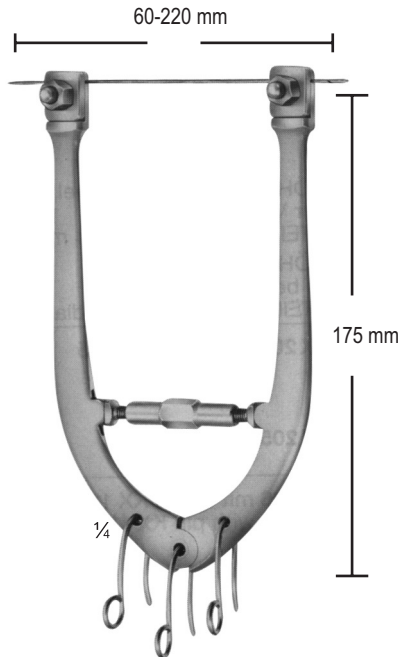

SS-19-566
Wire traction bow, adjustable,
with 3 hooks, large size

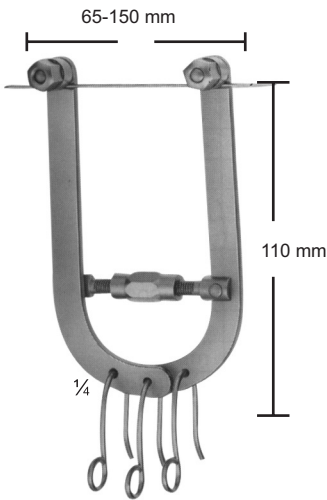

SS-19-567
Wire traction bow, adjustable,
with 3 hooks, large size for
elbow and calcaneus, for
adolescents

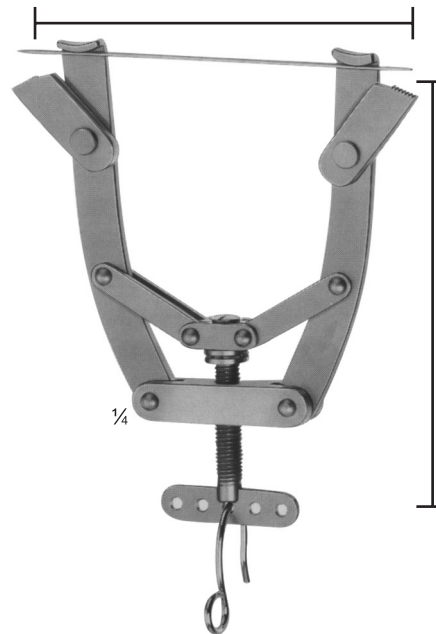

SS-19-570 10 cm
SS-19-571 16 cm
SS-19-572 20 cm

SS-19-573 1.6 mm
SS-19-574 2 mm
SS-19-575 2.5 mm

KIRSCHNER
SS-19-570 - SS-19-575
Wire traction bow, modified
adjustable in with width, holds wire
securely, with 1 hook



SS-19-568
Fixation disc, slotted

to X-rays



SS-19-576 1/2
Fixation disc, slotted



SS-19-577
Screw driver, for above
fixations discs

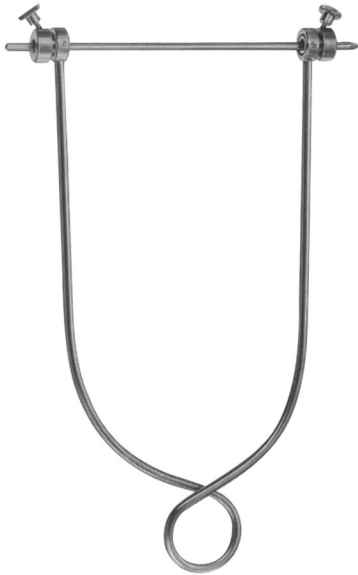

SS-19-578 - PS-585
Screw driver, for above
fixations discs

Steinmann pins, 4 mm daim.	Steinmann pins, 5 mm daim.
SS-19-578 with pin	16x9cm Arm
SS-19-579 without	SS-19-580-00 without
SS-19-581 with pin	21x11cm Arm
SS-19-582 without	SS-19-583 without
	21x15cm Arm

SS-19-585 without
pin



SS-19-586
SCHWARZ
Traction bow for fingers,
to be used with KIRSCHNER-
wire up to 1.6 mm diam.

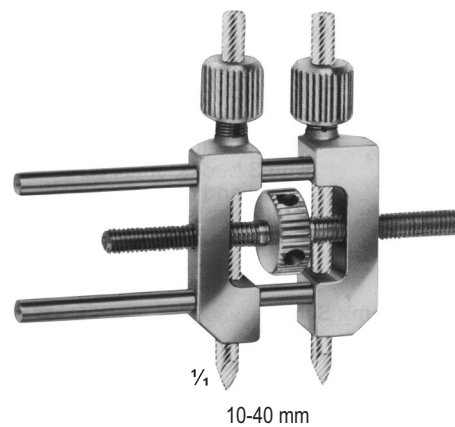

SS-19-587
Small distractor
as a repositioning device for
distraction and compression of small bones,
for wires with 3 mm diam.



STEINMANN
SS-19-588 - SS-500
triangular shaft ended and
trocar point

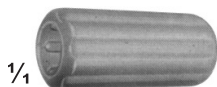

1/4
SS-19-603
Protection cap
for 4 mm STEINMANN Pins

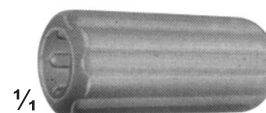

1/4
SS-19-604
Protection cap
for 5 mm STEINMANN Pins



REILL
SS-19-605
 Drilling chuck,
 cannulated,
 for shanks from
 2.0 - 2.5 mm diam
 115 mm

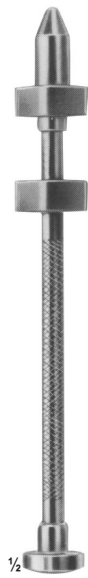

SS-19-606
 Drilling chuck,
 cannulated,
 for shanks from
 0.8 - 2.0 mm diam
 150 mm



SS-19-607
 Drilling chuck,
 cannulated,
 for shanks up to
 4.5 mm diam
 with key
 140 mm



LOUTE
SS-19-608
 Wire tightener, improved pattern,
 with movable tip,
 for wires up to 1.0 mm diam.
 220 mm



SS-19-609
 Drilling chuck, cannulated,
 for shanks up to 6.35 mm diam.,
 To be tightened by hand
 100 mm



SS-19-610
 Drilling chuck, cannulated,
 for shanks up to 4.5 mm diam.,
 And for triangular shaft width
 across flats 4.7 mm

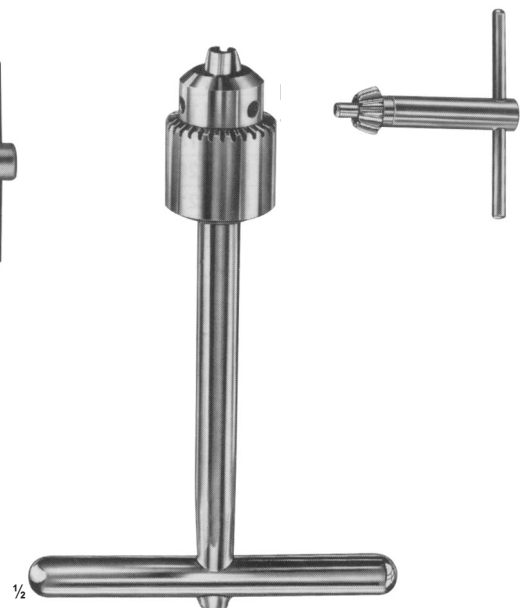

SS-19-611
 Drilling chuck, cannulated,
 for shanks up to 6.35 mm diam.,
 With key
 160 mm



SS-19-612
Nail extracting
forceps
135 mm

SS-19-613
Nail extracting
forceps
145 mm

MARTIN-IDEAL
SS-19-614 - SS-19-616
Finger nail drill
with 3 points

SS-19-614 SS-19-615
SS-19-616 Drill points
only



SS-19-617
Nail splitting
forceps
135 mm

SYSTRUNK
SS-19-618
Scissors, for
splitting finger nails
130 mm

SS-19-619
Finger ring saw
150 mm

Spare blade

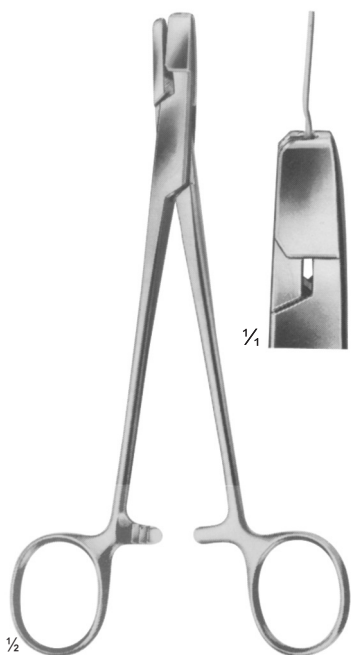

**DUROGRIP
SS-19-620**
Holding forceps for cerclage
wire, with lateral jaws to avoid
wire slipping off
170 mm



**DUROGRIP
SS-19-621**
Wire, tightening pliers,
Ligature pliers
150 mm



**DUROGRIP
SS-19-622**
Wire, tightening pliers,
Ligature pliers
150 mm

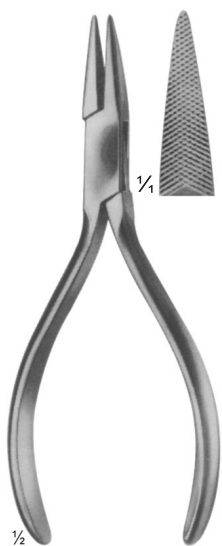

SS-19-623
with serrated jaws
140 mm

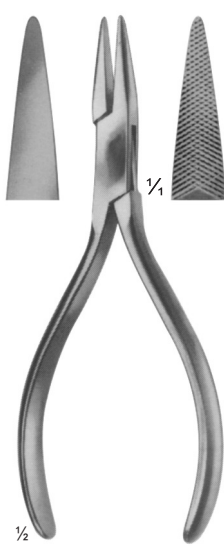

SS-19-624
one jaws smooth,
one jaws serrated
140 mm



SS-19-625
with serrated jaws
SS-19-626
with longitudinal and
transversal grooves
170 mm

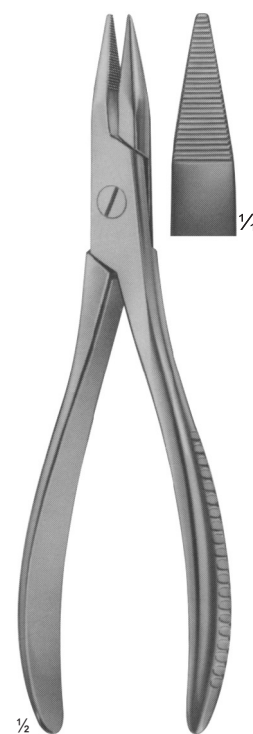

SS-19-627
190 mm



Durotip

SS-19-628
Cutter for cutting off
KIRSCHNER wires,
Tibia head screws,
bolts, pins, up to 6 mm diam.
47 cm



SS-19-629
 For Soft Wire \varnothing cm 3.5
 For Hars Wire \varnothing cm 2.5
 22 cm



SS-19-630
 For Soft Wire \varnothing cm 2.0
 For Hars Wire \varnothing cm 1.5
 22 cm

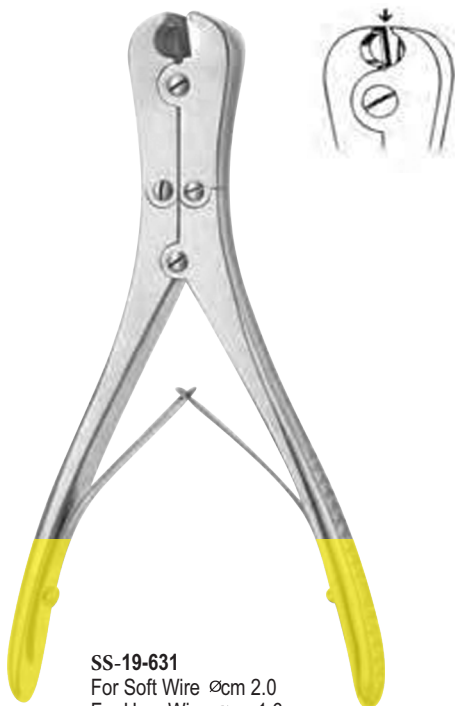

SS-19-631
 For Soft Wire \varnothing cm 2.0
 For Hars Wire \varnothing cm 1.6
 18 cm



SS-19-632
 17 cm

WE HAVE ALL RANGE OF INSTRUMENTS



CONTACT INFO



+92-340 0473111



swisons.ind@gmail.com



www.swisons.com



Small Industrial Estate, Sialkot 51310 Pakistan

Get your high quality Instruments