

SWISONS

SURGICALS

- NeuroSurgery
- Laminectomy





WAGENER
SS-21-101 -
SS-21-104 150 mm



¼
SS-21-101



¼
SS-21-102



¼
SS-21-103



¼
SS-21-104



GRAEFE
SS-21-105 -
SS-21-107 140 mm



¼
SS-21-105



¼
SS-21-106



¼
SS-21-107



BROM
SS-21-108
Vein hook
170 mm



¼



CRILE
SS-21-109
200 mm



¼



CUSHING
SS-21-110-
SS-21-111 190 mm



¼
SS-21-110



¼
SS-21-111

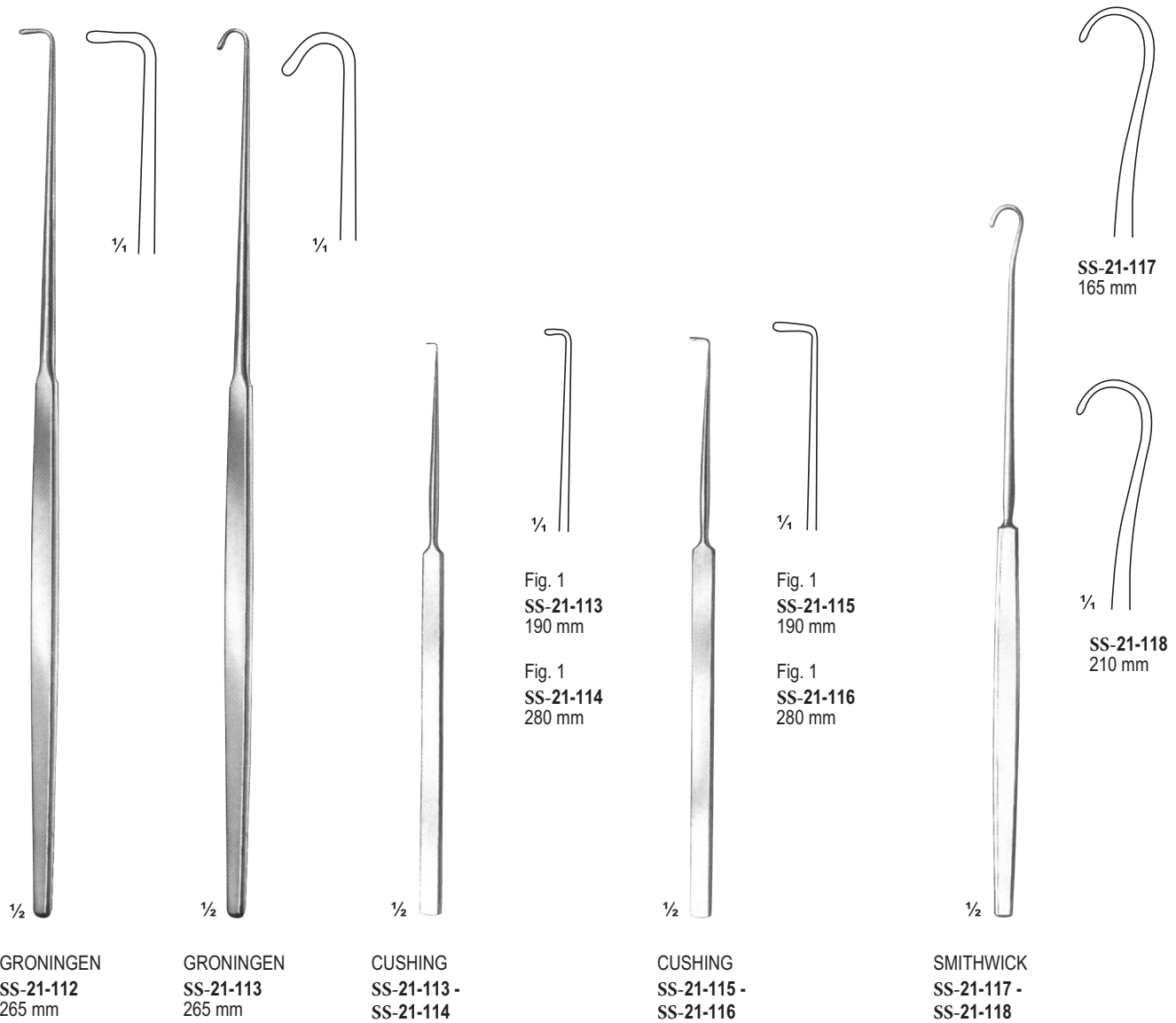



1/2

KRAYENBUHI
SS-21-119 -
SS-21-122 190 mm



Fig.1
SS-21-119



Fig.2
SS-21-120



Fig.1
SS-21-121



Fig.2
SS-21-122



1/2

CASPER
SS-21-123 -
SS-21-126 245 mm



SS-21-123



SS-21-124



SS-21-125



SS-21-126

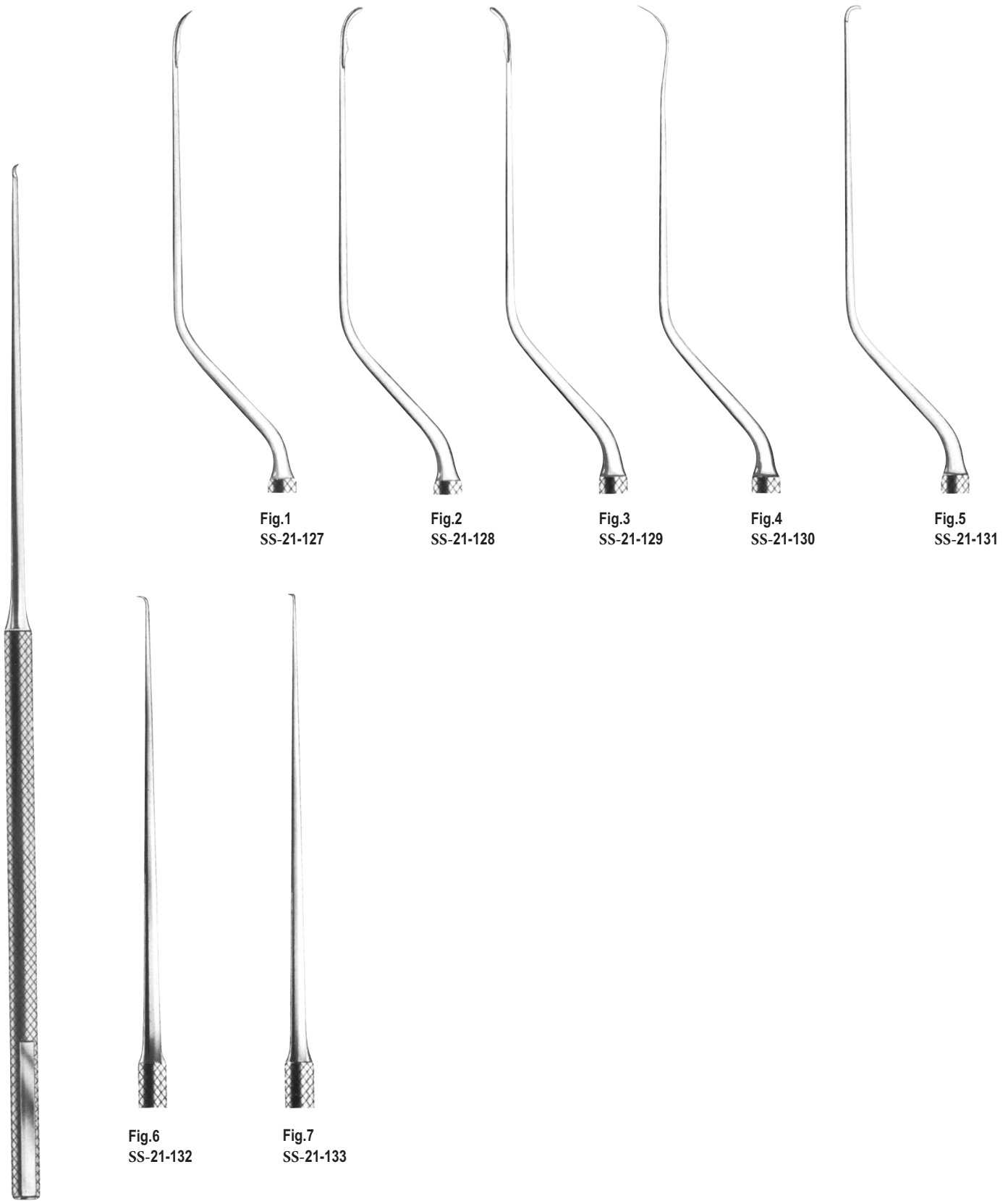

Fig.1
SS-21-127

Fig.2
SS-21-128

Fig.3
SS-21-129

Fig.4
SS-21-130

Fig.5
SS-21-131

Fig.6
SS-21-132

Fig.7
SS-21-133

SS-21-127 - SS-21-133

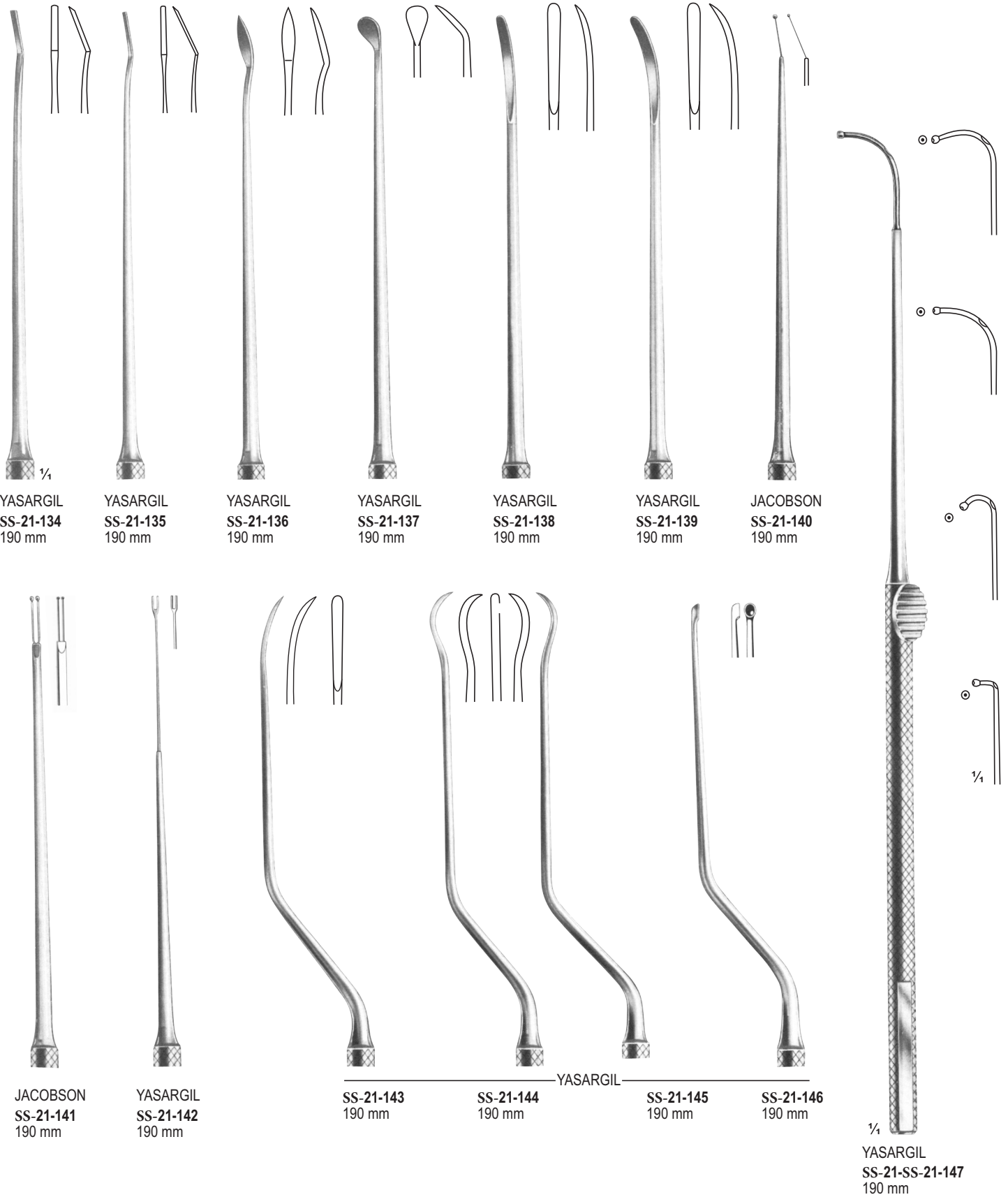

YASARGIL
SS-21-134
190 mm

YASARGIL
SS-21-135
190 mm

YASARGIL
SS-21-136
190 mm

YASARGIL
SS-21-137
190 mm

YASARGIL
SS-21-138
190 mm

YASARGIL
SS-21-139
190 mm

JACOBSON
SS-21-140
190 mm

JACOBSON
SS-21-141
190 mm

YASARGIL
SS-21-142
190 mm

SS-21-143
190 mm

SS-21-144
190 mm

YASARGIL

SS-21-145
190 mm

SS-21-146
190 mm

1/4
YASARGIL
SS-21-SS-21-147
190 mm



YASARGIL
SS-21-148 -
SS-21-149 Galea
Hook

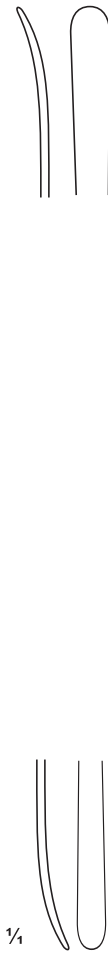

TOENNIS
SS-21-150
240 mm



OLIVECRONA
SS-21-151
240 mm



HESS
Nerve Root Retractor
SS-21-152 - SS-21-154
SS-21-152 175 mm 3 mm
SS-21-153 175 mm 5 mm
SS-21-154 175 mm 7 mm

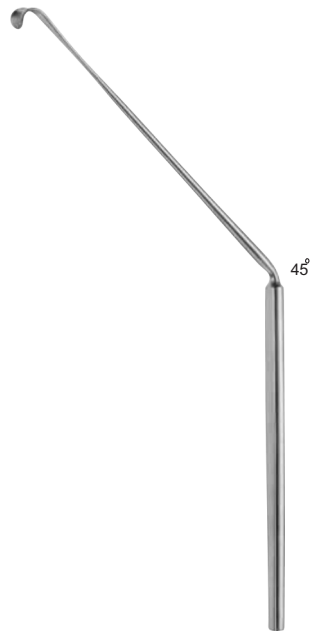

LOVE
Nerve Root Retractor
SS-21-155 - SS-21-157
SS-21-155 190 mm 30°
SS-21-156 190 mm 45°
SS-21-157 190 mm 90°



CASPAR
Nerve Root Retractor
SS-21-158 - SS-21-160
SS-21-158 245 mm 6 mm
SS-21-159 245 mm 8 mm
SS-21-160 245 mm 10 mm



LOVE
SS-21-161
210 mm

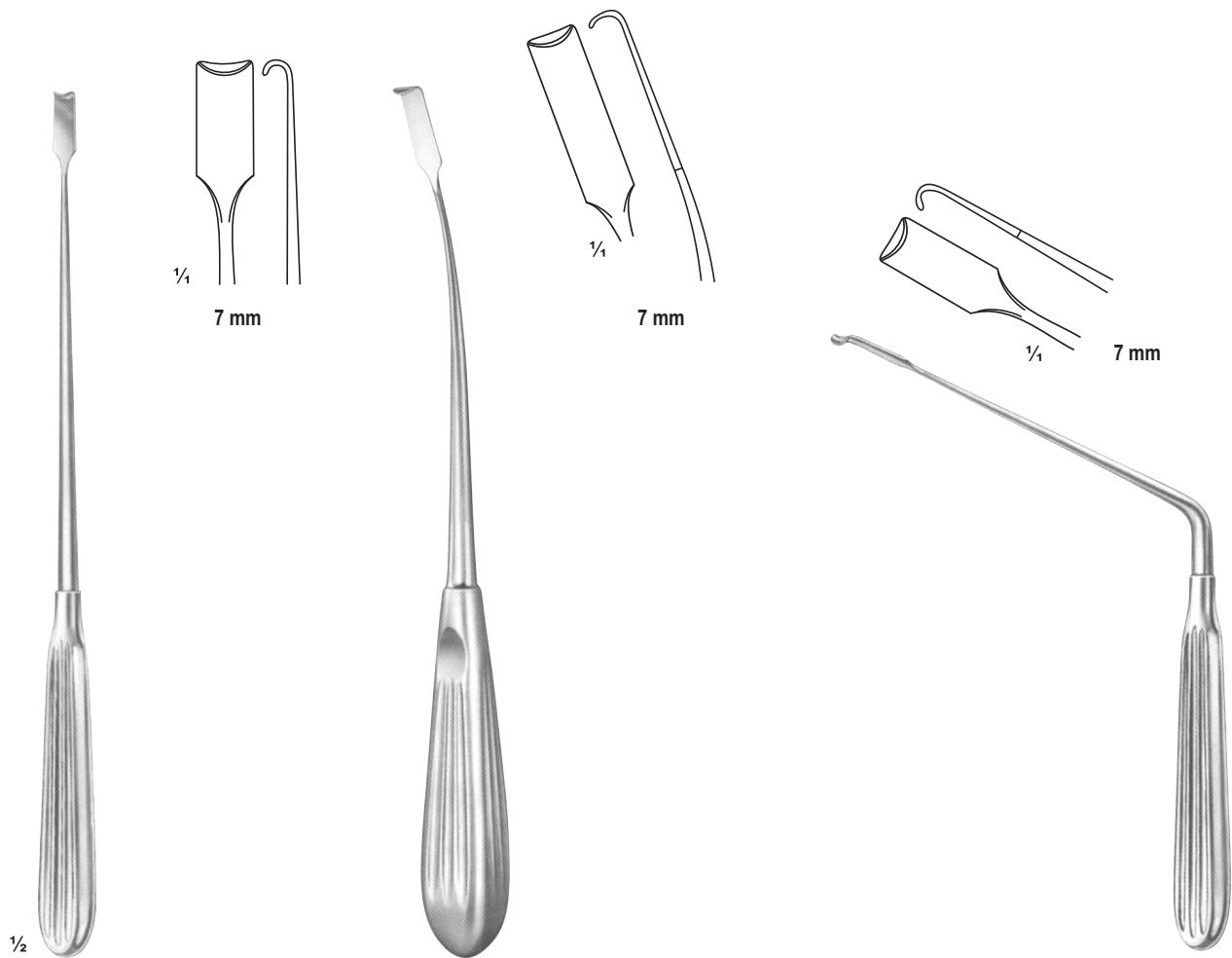

SCOVILLE
SS-21-162
235 mm

HOLSHER
SS-21-163
240 mm

SCOVILLE
SS-21-164
165 mm



LEYLA
SS-21-165
Self-Retaining brain retractor
with 2 arms complete

LEYLA BED RETRACTOR
SS-21-166
Self-Retaining brain retractor
bed retractor not illustrated

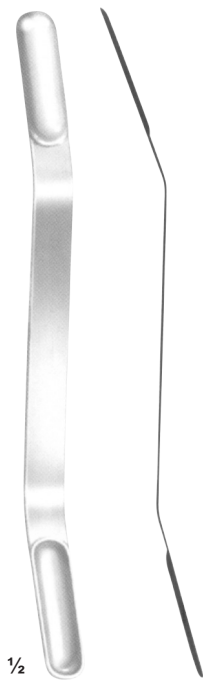

OLIVECRONA
 SS-21-167 - SS-21-170
 180 mm
 Concave

- SS-21-167 7 + 9 mm
- SS-21-168 11 + 13 mm
- SS-21-169 15 + 18 mm
- SS-21-170 18 + 22 mm



SS-21-171
 15.5 cm
 11 mm

SS-21-172
 20 cm
 14 mm

SS-21-173
 20 cm
 17 mm

SS-21-174
 20 cm
 20 mm

HEIFETZ
 SS-21-171 -
 SS-21-174

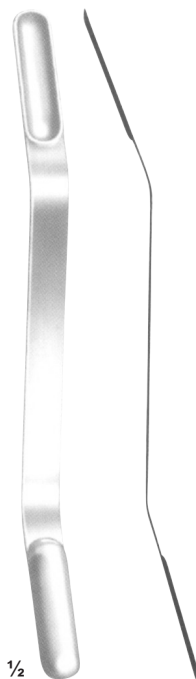

OLIVECRONA
 SS-21-175 - SS-21-178
 180 mm
 Convex

- SS-21-175 7 + 9 mm
- SS-21-176 11 + 13 mm
- SS-21-177 15 + 18 mm
- SS-21-178 18 + 22 mm



SS-21-179
 8 mm

SS-21-180
 14 mm

SS-21-181
 17 mm

HEIFETZ
 SS-21-179 -
 SS-21-181 155 mm



**CASPAR
SS-21-182**
Transverse Retractor hinged
65 mm regular spread
110 mm wide spread



**CASPAR
SS-21-183**
Transverse Retractor double-hinged
65 mm spread



**CASPAR
SS-21-184**
Longitudinal Retractor
double-hinged, ring handle
205 mm
85 mm spread



**CASPAR
SS-21-185**
Specula Retractor single-hinged,
115 mm
70mm regular spread



SS-21-186 - SS-21-194
SS-21-187 23 x 35 mm
SS-21-188 23 x 40 mm
SS-21-189 23 x 45 mm
SS-21-190 23 x 50 mm
SS-21-191 23 x 55 mm
SS-21-192 23 x 60 mm
SS-21-193 23 x 65 mm
SS-21-194 23 x 70 mm
Medial Toothed Blades
Stainless Steel



SS-21-195 - SS-21-199
SS-21-195 15 x 40 mm
SS-21-196 15 x 45 mm
SS-21-197 15 x 50 mm
SS-21-198 15 x 55 mm
SS-21-199 15 x 60 mm
Small Lateral Blades
Stainless Steel



SS-21-200 - SS-21-206
SS-21-200 23 x 40 mm
SS-21-201 23 x 45 mm
SS-21-196 15 x 45 mm
SS-21-197 15 x 50 mm
SS-21-202 23 x 50 mm
SS-21-203 23 x 55 mm
SS-21-204 23 x 60 mm
SS-21-205 23 x 65 mm
SS-21-206 23 x 70 mm
Lateral Serrated Blades
Stainless Steel



Cervical Blades
Stainless Steel – fenestrated
SS-21-207 - SS-21-208
SS-21-207 25 x 50 mm
SS-21-208 25 x 60 mm



SS-21-209 - SS-21-217
SS-21-209 23 x 35 mm
SS-21-210 23 x 40 mm
SS-21-211 23 x 45 mm
SS-21-212 23 x 50 mm
SS-21-213 23 x 55 mm
SS-21-214 23 x 60 mm
SS-21-215 23 x 65 mm
SS-21-216 23 x 70 mm
SS-21-217 23 x 75 mm
Blunt Blades Stainless
Steel



721-218 - SS-21-222
SS-21-218 23 x 40 mm
SS-21-219 23 x 45 mm
SS-21-220 23 x 50 mm
SS-21-221 23 x 55 mm
SS-21-222 23 x 60 mm
Medial Toothed Blades
Aluminium – rotatating



SS-21-223 - SS-21-227
SS-21-223 23 x 40 mm
SS-21-224 23 x 45 mm
SS-21-225 23 x 50 mm
SS-21-226 23 x 55 mm
SS-21-227 23 x 60 mm
Lateral Serrated Blades
Aluminium – rotatating



SS-21-228 - SS-21-232
SS-21-228 23 x 45 mm
SS-21-229 23 x 50 mm
SS-21-230 3 x 55 mm
SS-21-231 23 x 60 mm
SS-21-232 23 x 65 mm
Blunt Blades Aluminium –
rotatating



CASPAR
SS-21-2
Transverse Retractor hinged
65 mm spread

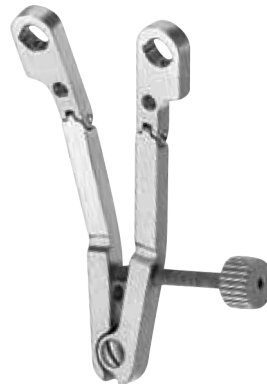

CASPAR
SS-21-234
Specula Retractor single-hinged
115 mm,
70 mm spread



CASPAR
SS-21-235
Longitudinal Retractor
single-hinged ring
handle 175 mm 70
mm spread



SS-21-236 - SS-21-243
SS-21-236 20 x 40 mm
SS-21-237 20 x 45 mm
SS-21-238 20 x 50 mm
SS-21-239 20 x 55 mm
SS-21-240 20 x 60 mm
SS-21-241 20 x 65 mm
SS-21-242 20 x 70 mm
SS-21-243 20 x 75 mm
Medial Toothed Blades



SS-21-244 - SS-21-254
SS-21-244 20 x 25 mm
SS-21-245 20 x 30 mm
SS-21-246 20 x 35 mm
SS-21-247 20 x 40 mm
SS-21-248 20 x 45 mm
SS-21-249 20 x 50 mm
SS-21-250 20 x 55 mm
SS-21-251 20 x 60 mm
SS-21-252 20 x 65 mm
SS-21-253 20 x 70 mm
SS-21-254 20 x 75 mm
Lateral Serrated Blades



SS-21-255 - SS-21-264
SS-21-255 20 x 30 mm
SS-21-256 20 x 35 mm
SS-21-257 20 x 40 mm
SS-21-258 20 x 45 mm
SS-21-259 20 x 50 mm
SS-21-260 20 x 55 mm
SS-21-261 20 x 60 mm
SS-21-262 20 x 65 mm
SS-21-263 20 x 70 mm
SS-21-264 20 x 75 mm
Blunt Blades



SS-21-265 - SS-21-272
SS-21-265 20 x 35 mm
SS-21-266 20 x 40 mm
SS-21-267 20 x 45 mm
SS-21-268 20 x 50 mm
SS-21-269 20 x 55 mm
SS-21-270 20 x 60 mm
SS-21-271 20 x 65 mm
SS-21-272 20 x 70 mm
Medial Toothed Blades
fenestrated



SS-21-273 - SS-21-282
SS-21-273 20 x 25 mm
SS-21-274 20 x 30 mm
SS-21-275 20 x 35 mm
SS-21-276 20 x 40 mm
SS-21-277 20 x 45 mm
SS-21-278 20 x 50 mm
SS-21-279 20 x 55 mm
SS-21-280 20 x 60 mm
SS-21-281 20 x 65 mm
SS-21-282 20 x 70 mm
Lateral Serrated Blades
Fenestrated



SS-21-283 - SS-21-291
SS-21-283 20 x 35 mm
SS-21-284 20 x 40 mm
SS-21-285 20 x 45 mm
SS-21-286 20 x 50 mm
SS-21-287 20 x 55 mm
SS-21-288 20 x 60 mm
SS-21-289 20 x 65 mm
SS-21-290 20 x 70 mm
SS-21-291 20 x 75 mm
Blunt Blades Fenestrated



CASPAR
SS-21-2
Transverse Retractor hinged
60 mm spread



CASPAR
SS-21-2
Transverse Retractor double-hinged
65 mm spread



CASPAR
SS-21-294 Longitudinal
Retractor single-hinged
ring handle 175 mm
70 mm spread



CASPAR
SS-21-295 Longitudinal
Retractor single-hinged
ring handle 175 mm
70 mm spread



SS-21-296 - SS-21-302
 SS-21-296 12 x 40 mm
 SS-21-297 12 x 45 mm
 SS-21-298 12 x 50 mm
 SS-21-299 12 x 55 mm
 SS-21-300 12 x 60 mm
 SS-21-301 12 x 65 mm
 SS-21-302 12 x 75 mm
 Small Lateral Serrated
 Blades PEEK



SS-21-303 - SS-21-309
 SS-21-303 23 x 40 mm
 SS-21-304 23 x 45 mm
 SS-21-305 23 x 50 mm
 SS-21-306 23 x 55 mm
 SS-21-307 23 x 60 mm
 SS-21-308 23 x 65 mm
 SS-21-309 23 x 75 mm
 Lateral Serrated Blades
 PEEK



SS-21-310 - SS-21-316
 SS-21-310 23 x 40 mm
 SS-21-311 23 x 45 mm
 SS-21-312 23 x 50 mm
 SS-21-313 23 x 55 mm
 SS-21-314 23 x 60 mm
 SS-21-315 23 x 65 mm
 SS-21-316 23 x 75 mm
 Blunt Blades PEEK



SS-21-317 - SS-21-323
 SS-21-317 23 x 40 mm
 SS-21-318 23 x 45 mm
 SS-21-319 23 x 50 mm
 SS-21-320 23 x 55 mm
 SS-21-321 23 x 60 mm
 SS-21-322 23 x 65 mm
 SS-21-323 23 x 75 mm
 Medial Toothed Blades
 PEEK



SS-21-324 - SS-21-330
 SS-21-324 23 x 40 mm
 SS-21-325 23 x 45 mm
 SS-21-326 23 x 50 mm
 SS-21-327 23 x 55 mm
 SS-21-328 23 x 60 mm
 SS-21-329 23 x 65 mm
 SS-21-330 23 x 75 mm
 Lateral Serrated Blades
 PEEK – rotatating



SS-21-331 - SS-21-337
 SS-21-331 23 x 40 mm
 SS-21-332 23 x 45 mm
 SS-21-333 23 x 50 mm
 SS-21-334 23 x 55 mm
 SS-21-335 23 x 60 mm
 SS-21-336 23 x 65 mm
 SS-21-337 23 x 75 mm
 Blunt Blades
 PEEK – rotatating

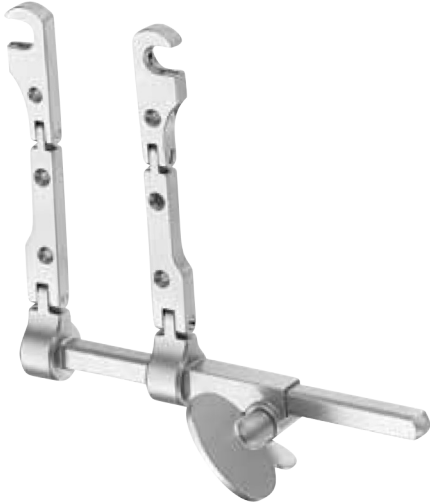

CASPAR
SS-21-338
 Transverse Retractor double-hinged
 quick connect 72 mm spread, side-loading



CASPAR
SS-21-339
 Longitudinal Retractor double-hinged,
 ring handle, quick connect
 185 mm
 75 mm spread, side-loading



CASPAR
SS-21-340
 Specula Retractor single-hinged,
 quick connect
 115 mm
 70 mm spread, side-loading



CASPAR
SS-21-341
 Quick Connect Blade
 Positioner Handle
 210 mm
 for quick connect
 blades only



SS-21-342 - SS-21-346
SS-21-342 23 x 40 mm
SS-21-343 23 x 45 mm
SS-21-344 23 x 50 mm
SS-21-345 23 x 55 mm
SS-21-346 23 x 60 mm
 Medial Toothed Blades
 Stainless Steel
 quick connect



SS-21-347 - SS-21-351
SS-21-347 23 x 40 mm
SS-21-348 23 x 45 mm
SS-21-349 23 x 50 mm
SS-21-350 23 x 55 mm
SS-21-351 23 x 60 mm
 Lateral Serrated Blades
 Stainless Steel
 quick connect



SS-21-352 - SS-21-356
SS-21-352 23 x 45 mm
SS-21-353 23 x 50 mm
SS-21-354 23 x 55 mm
SS-21-355 23 x 60 mm
SS-21-356 23 x 65 mm
 Blunt Blades Stainless
 Steel
 quick connect



SS-21-357 - SS-21-361
SS-21-357 23 x 40 mm
SS-21-358 23 x 45 mm
SS-21-359 23 x 50 mm
SS-21-360 23 x 55 mm
SS-21-361 23 x 60 mm
 Medial Toothed Blades
 Titanium
 quick connect



SS-21-362 - SS-21-366
SS-21-362 23 x 40 mm
SS-21-363 23 x 45 mm
SS-21-364 23 x 50 mm
SS-21-365 23 x 55 mm
SS-21-366 23 x 60 mm
 Lateral Serrated Blades
 Titanium
 quick connect



SS-21-367 - SS-21-371
SS-21-367 23 x 45 mm
SS-21-368 23 x 50 mm
SS-21-369 23 x 55 mm
SS-21-370 23 x 60 mm
SS-21-371 23 x 65 mm
 Blunt Blades
 Titanium
 quick connect



CASPAR
SS-21-372
 Caspar Cervical Spine Retractor
 stainless steel, complete set for transverse retraction, 65 mm
 spread, adjustable, with 5 medial and 5 lateral stainless steel,
 blades 40, 45, 50, 55, 60 mm

SS-21-373
 TI Caspar Cervical Spine Retractor
 titanium, complete set for transverse retraction, 65 mm
 spread, adjustable, with 5 medial and 5 lateral titanium
 blades 40, 45, 50, 55, 60 mm



CASPAR
SS-21-374
 Caspar Microdiscectomy Retractor
 for microsurgical treatment of
 herniated lumbar discs
 45 mm spread



SS-21-375 - SS-21-383
 SS-21-375 35 mm
 SS-21-376 40 mm
 SS-21-377 45 mm
 SS-21-378 50 mm
 SS-21-379 55 mm
 SS-21-380 60 mm
 SS-21-381 65 mm
 SS-21-382 75 mm
 SS-21-383 85 mm
 Lateral Blades



SS-21-384 - SS-21-390
 SS-21-384 40 mm
 SS-21-385 45 mm
 SS-21-386 50 mm
 SS-21-387 55 mm
 SS-21-388 60 mm
 SS-21-389 65 mm
 SS-21-390 70 mm
 Paraspina Blades



CASPAR
SS-21-391 - SS-21-400
 SS-21-391 40 mm
 SS-21-392 45 mm
 SS-21-393 50 mm
 SS-21-394 55 mm
 SS-21-395 60 mm
 SS-21-396 65 mm
 SS-21-397 70 mm
 SS-21-398 75 mm
 SS-21-399 80 mm
 SS-21-400 85 mm
 Lumbar Speculum
 fenestrated



SS-21-405 - SS-21-410
SS-21-405 20 x 30 mm
SS-21-406 20 x 40 mm
SS-21-407 20 x 50 mm
SS-21-408 20 x 60 mm
SS-21-409 20 x 70 mm
SS-21-410 20 x 80 mm
 McCulloch 4-teeth Narrow
 Muscle Blades



SS-21-411 - SS-21-416
SS-21-411 20 x 30 mm
SS-21-412 20 x 40 mm
SS-21-413 20 x 50 mm
SS-21-414 20 x 60 mm
SS-21-415 20 x 70
 mm **SS-21-416** 20 x
 80 mm McCulloch
 6-teeth Wide
 Muscle Blades

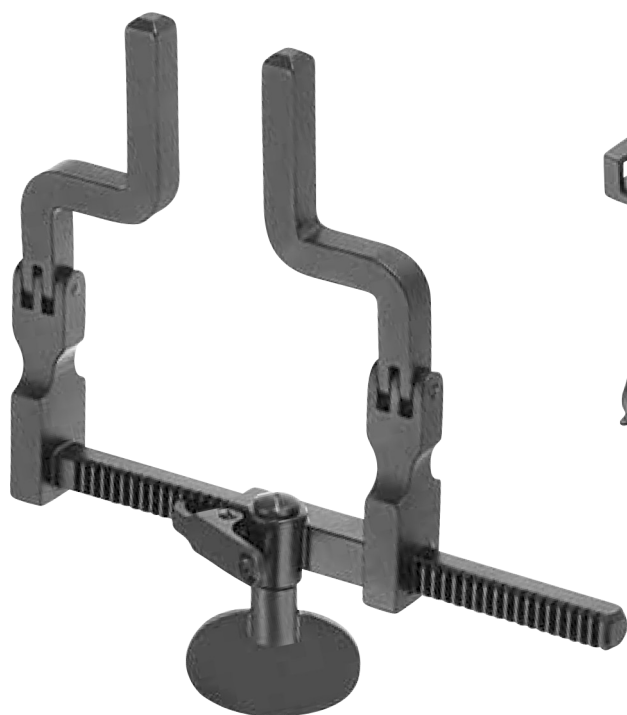

CASPAS
 McCulloch Lumbar Spine Retractor for Microdiscectomy,
 black silicone bead
SS-21-401 68 mm spread, hinged
SS-21-402 68 mm spread, rigid
SS-21-403 90 mm spread, rigid
 McCulloch Lumbar Spine Retractor Tray
SS-21-404 Tray 265 x 265 mm for Container (not
 illustrated)



SS-21-417 - SS-21-422
SS-21-417 20 x 30 mm
SS-21-418 20 x 40 mm
SS-21-419 20 x 50 mm
SS-21-420 20 x 60 mm
SS-21-421 20 x 70 mm
SS-21-422 20 x 80 mm
 McCulloch 2-teeth Thin
 Muscle Blades



SS-21-423 - SS-21-430
SS-21-423 20 mm
SS-21-424 30 mm
SS-21-425 40 mm
SS-21-426 50 mm
SS-21-427 60 mm
SS-21-428 70 mm
SS-21-429 80 mm
SS-21-430 90 mm
 McCulloch Hook Blades



SS-21-431 - SS-21-438
SS-21-431 20 mm
SS-21-432 30 mm
SS-21-433 40 mm
SS-21-434 50 mm
SS-21-435 60 mm
SS-21-436 70 mm
SS-21-437 80 mm
SS-21-438 90 mm
 McCulloch toothed Hook
 Blades



SS-21-439 - SS-21-441
SS-21-439 20 x 50 mm
SS-21-440 20 x 60 mm
SS-21-441 20 x 70 mm
 McCulloch 2-teeth
 Cervical Blades



CASPAR
SS-21-442 - SS-21-443
 Caspar Vertebral Column Retractor
 for Laminectomy and Hemilaminectomy (Lumbar, Thoracal,
 Cervical), stainless steel, complete set, 145 mm spread,
SS-21-442 125 mm arms, consisting of
SS-21-443 145 mm spread, hinged includes
 Screw Driver for spreading bar



CASPAR
SS-21-444
 Screw driver four
 spreading bar



CASPAR
SS-21-445
 Blade Changing Forceps
 115 mm



SS-21-446 - SS-21-447
SS-21-446 38 mm
SS-21-447 58 mm



SS-21-448 - SS-21-455
SS-21-448 22 x 32 mm
SS-21-449 22 x 37 mm
SS-21-450 22 x 43 mm
SS-21-451 22 x 47 mm
SS-21-452 22 x 52 mm
SS-21-453 22 x 57 mm
SS-21-454 22 x 62 mm
SS-21-455 22 x 67 mm



SS-21-456 - SS-21-463
SS-21-456 37 x 32 mm
SS-21-457 37 x 37 mm
SS-21-458 37 x 43 mm
SS-21-459 37 x 47 mm
SS-21-460 37 x 52 mm
SS-21-461 37 x 57 mm
SS-21-462 37 x 62 mm
SS-21-463 37 x 67 mm



SS-21-464 - SS-21-471
SS-21-464 57 x 32 mm
SS-21-465 57 x 37 mm
SS-21-466 57 x 43 mm
SS-21-467 57 x 47 mm
SS-21-468 57 x 52 mm
SS-21-469 57 x 57 mm
SS-21-470 57 x 62 mm
SS-21-471 57 x 67 mm



CASPAR
SS-21-472
 Distractor only for use in surgical procedures from the left approach the right approach for the upper cervical spine Distractor as above but with elongated toothed bar for multilevel (more than 2 distraction)

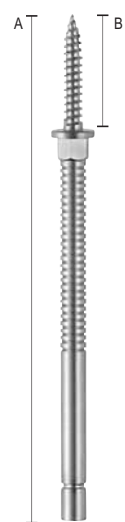

DISTRACTION		PIN
A/B		
66/12	mm	SS-21-473
68/14	mm	SS-21-474
70/16	mm	SS-21-475
SS-21-476	72/18 mm	



TWIST DRILL
SS-21-477



DRILL GUIDE
SS-21-478



SCREW DRIVER
SS-21-479



CASPAR
SS-21-480
 Distractor only for use in surgical procedures from the left approach the right approach for the upper cervical spine Distractor as above but with elongated toothed bar for multilevel (more than 2 distraction)

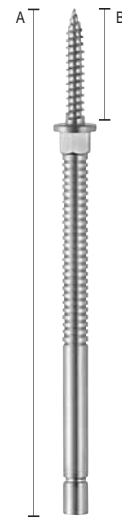

DISTRACTION	PIN	A/B	TWIST DRILL
SS-21-481	- SS-21-484		SS-21-485
SS-21-481	66/12	mm	
SS-21-482	68/14	mm	
SS-21-483	70/16	mm	
SS-21-484	72/18	mm	



DRILL GUIDE
SS-21-486



SCREW DRIVER
SS-21-487



CLOWARD-TYPE
SS-21-488
 Vertebra
 Spreaders 130 mm
 18 mm spread



SS-21-489
 one pointed tip
 70 mm
 arm, 80 mm spread



three pointed tips
SS-21-490
 850 mm arm,
 70 mm spread
SS-21-491
 100 mm
 arm, 70 mm spread



INGE
 Lamina Spreaders
SS-21-492 - SS-21-493
SS-21-492 165 mm
SS-21-493 270 mm

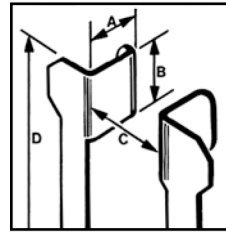

SCOVILLE-HAVERFIELD

	A	B	C	D
SS-21-494	50 mm	35 mm	140 mm	140 mm
	50 mm			
with 1 each blade 29-3165.50 and 29-3162.51				
Frame only, hinged:				
SS-21-495		140 mm	140 mm	



Toothed:

SS-21-502 - SS-21-507	
SS-21-502	63 mm x 26 mm
SS-21-503	66 mm x 30 mm
SS-21-504	89 mm x 26 mm
SS-21-505	51 mm x 51 mm
SS-21-506	63 mm x 51 mm
SS-21-507	76 mm x 51 mm



3-prongs:

SS-21-496 44 mm x 38 mm

4-prongs:

SS-21-497 - SS-21-501	
SS-21-497	41 mm x 38 mm
SS-21-498	66 mm x 48 mm
SS-21-499	48 mm x 51 mm
SS-21-500	63 mm x 63 mm
SS-21-501	82 mm x 58 mm



Hook-shaped, blunt:

SS-21-508 - SS-21-509	
SS-21-508	50 mm
SS-21-509	75 mm



Williams
SS-21-510
 for microsurgical treatment
 of herniated discs
 170 mm
w = 10 mm
SS-21-511 10 x 50 mm
SS-21-512 10 x 60 mm
SS-21-513 10 x 70 mm

w = 20 mm
SS-21-514 20 x 50 mm
SS-21-515 20 x 60 mm
SS-21-516 20 x 70 mm



Williams
SS-21-517
 for microsurgical treatment
 of herniated discs
 170 mm
w = 10 mm
SS-21-518 10 x 50 mm
SS-21-519 10 x 60 mm
SS-21-520 10 x 70 mm

w = 20 mm
SS-21-521 20 x 50 mm
SS-21-522 20 x 60 mm
SS-21-523 20 x 70 mm



CLOWARD-TYPE
SS-21-524
 with slide lock Cervical Retractor Set with slide-lock complete with 14 blades, 25 cm **SS-21-525**
 – **SS-21-526**
SS-21-527 Retractor Body only (without blades, 25 cm)



SS-21-528
 Cervical Retractor Set with slide-lock complete with 14 blades, 16 cm
SS-21-529 – **SS-21-530**
SS-21-531 Retractor Body only (without blades, 160 mm)



SS-21-532 - **SS-21-538**
SS-21-532 25 mm
SS-21-533 30 mm
SS-21-534 35 mm
SS-21-535 40 mm
SS-21-536 45 mm
SS-21-537 50 mm
SS-21-538 55 mm blunt



SS-21-539 - **SS-21-545**
SS-21-539 25 mm
SS-21-540 30 mm
SS-21-541 35 mm
SS-21-542 40 mm
SS-21-543 45 mm
SS-21-544 50 mm
SS-21-545 55 mm blunt

Galea Hooks



YASARGIL
SS-21-546
31 cm

YASARGIL
SS-21-547
41 cm

Dura Protecting Forceps

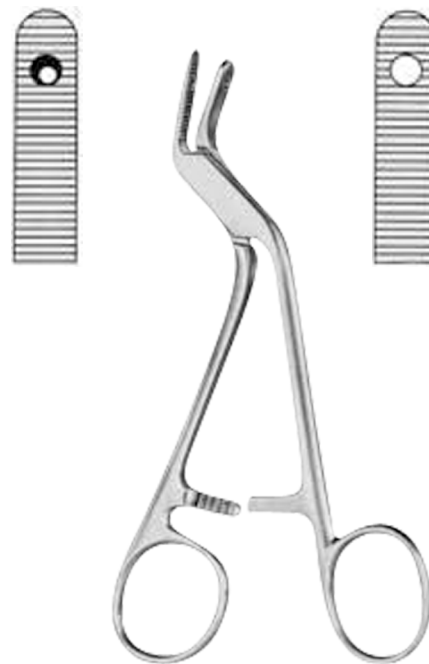

ADSON
SS-21-548
15 cm



SS-21-549
Silver Wires Mckenzie

Elio Carrier



MCKENZIE
SS-21-550
148x40x60 mm
One Clip Holding



MCKENZIE
SS-21-551
190x48x13 mm
Two Clips Holding

Silver Clips



SS-21-552

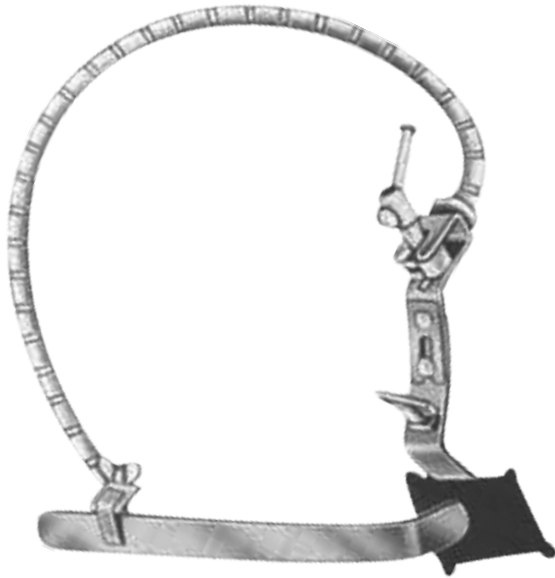

SS-21-553
Complete Brain Ttractor
Set With 1 Arm



SS-21-555
Complete Set

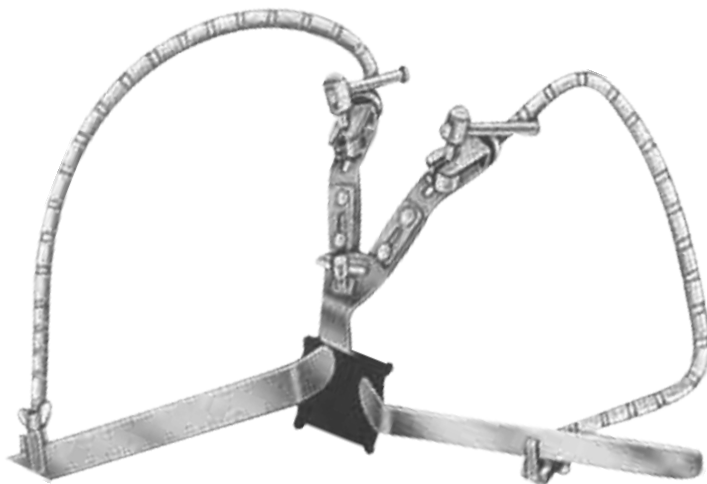

SS-21-554
Complete Brain Ttractor
Set With 2 Arm

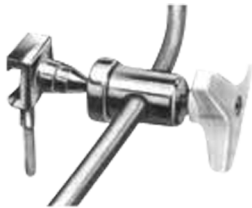

SS-21-556
Ball and Socket Joint



SS-21-557
Holding Rod, Head



SS-21-558
Coupling Head



SS-21-559 Fixation
Base for skull
Mounting Holding 1
Flexible Arm



SS-21-560 Fixation
Base for skull
Mounting, Holding 2
Flexible Arms



SS-21-561
Fixation Base for
Mounting to 16 mm Dia.
Holding 1 Flexible Arm

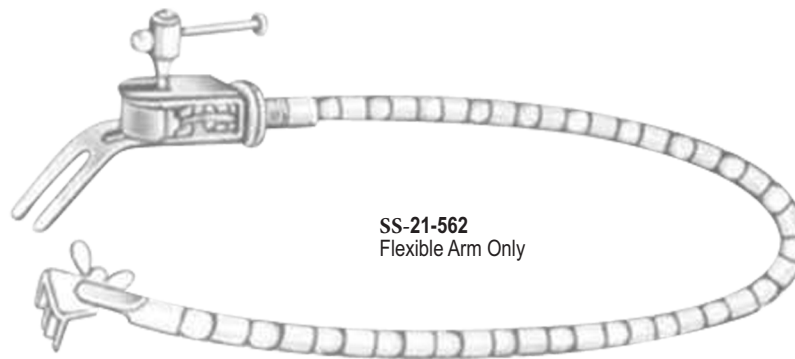

SS-21-562
Flexible Arm Only



SS-21-563
Support for Flat
Brain Spatula



SS-21-564
Support for Brain Spatula
With Round Shaft



SS-21-565
Holded for Ear Spatula

WE HAVE ALL RANGE OF INSTRUMENTS



CONTACT INFO



+92-340 0473111



swisons.ind@gmail.com



www.swisons.com



Small Industrial Estate, Sialkot 51310 Pakistan

Get your high quality Instruments