



SWISONS

DENTAL

- Pliers For Orthodontics
- Mouth Gags
- Tongue Depressors Lip and Cheek
- Retractors and Implantology Instruments



Pinze per formare loops
Loops forming pliers



SS-7-5101
Adams

Adams pliers for bending
wires up to 0,7mm. (.28").

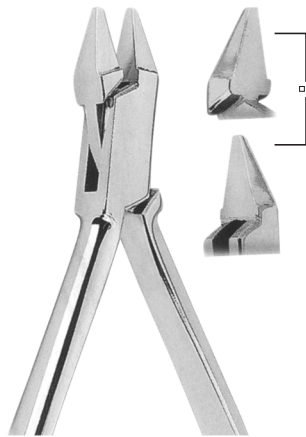

SS-7-5102
Adams

Adams pliers for bending
wires up to 0,7mm. (.28").

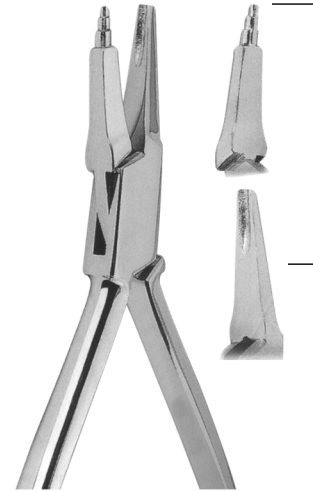

SS-7-5103
Adams

Tweed loop forming pliers.
For forming loop in wires up
to 0,56 mm. (.22").



SS-7-5104
Adams

Aderer three jaws bending
pliers. For wires up
to 0,7 mm. (.28").



SS-7-5105
Adams

Aderer three jaws bending
pliers. For wires upto 0,7 mm.
(.28").

Ligature Cutter Pliers



SS-7-5106

Micro-miniature light wire cutter. It cuts soft ligature wires. For use in caso of limited access. Caution: maximum cutting capacity: soft ligature wire up to 0,30 mm. (.012").



SS-7-5107

Wire cutter. For ligature wires and pins. It is strong enough to bend archwire ends after distal cutting. Maximum cutting capacity up to 0,56 x 0,7 mm. (.022" x .028").

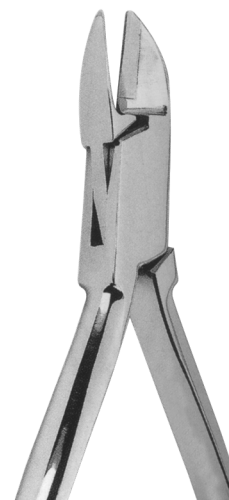

SS-7-5108

Wire cutter. For ligature wires and pins. It is strong enough to bend archwire ends after distal cutting. Maximum cutting capacity: up to 0,9 mm. (.036").



SS-7-5109

Wire cutter. For ligature wires and pins. It is strong enough to bend archwire ends after distal cutting. Maximum cutting capacity: up to 1,5 mm. (.044").

Pinze per formare laboratorio
Laboratory pliers



SS-7-5110

Flat nose pliers with smooth beaks for bending wires up to 0,7 mm. (.028").



SS-7-5111

Bending wires up to 0,7 mm. (.028").



SS-7-5112

Bending wires up to 0,7 mm. (.028").



SS-7-5113

Bending wires up to 0,7 mm. (.028").



SS-7-5114
Nance

Nance loop closing pliers, for bending of stop loops and special for Adams' clasps. Wires up to 0,7 mm. (.028").



SS-7-5115
Nance

Universal pliers for bending wires up to 0,9 mm. (.035") or cutting up to 0,7 mm. (.028").

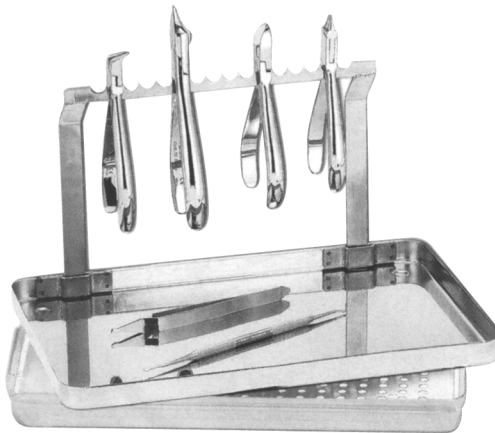

SS-7-5116

Stainless steel pliers tray standard dimensions



SS-7-5117
Universal

Universal pin roughening, cutting and bending pliers. For wires up to 0,9 mm. (.035"). Will cut wires up to 0,7 mm. (.028").

Utility and specialty pliers



SS-7-5118
Reynolds

Reynolds contouring pliers.



SS-7-5119
Reynolds

Lingual arch pliers used to form double and triple back bends in 0,7 mm (.028") or 0,9 mm (.035") wire for insertion in lingual sheaths.



SS-7-5120
Weingart

Weingart pliers with serrated points.

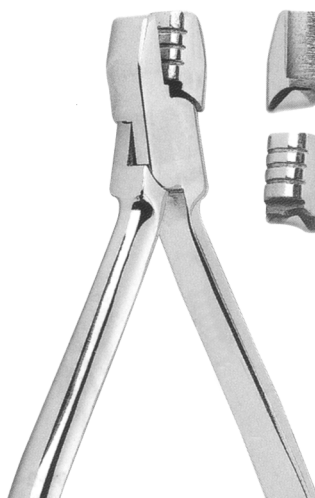

SS-7-5121
De La Rosa

De La Rosa arch forming pliers. Designed to form and contour arch wires on round or rectangular wire. The beak has grooves of 0,4 mm (.016"), 0,46 mm (.018") and 0,56 mm (.022").



SS-7-5122
De La Rosa

Arch forming pliers with a non grooved contouring surface the forming of precise arches.

Loop formare pliers



SS-7-5123
Waldsachs

Waldsachs universal pliers for bending wires up to 1,0 mm. (.039") or cutting up to 0,7 mm. (.028").



SS-7-5124

Round and Concave pliers for loop forming and bending of thin round and square wires up to 0,5 mm. (.020").

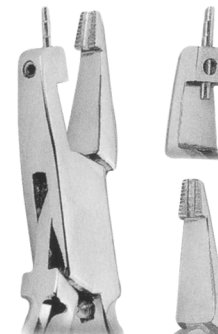

SS-7-5125
Tweed

Tweed loop Forming Pliers. For round or rectangular wires up to 0,56 x 0,7 mm. (.022" x .028"). Replaceable cylindrical beak with three sizes: 1,15 mm. (.045), 1,50 mm. (.059"), 1,90 mm. (.075"). Concave beak with slight parallel serrations, to keep the wire in proper position.

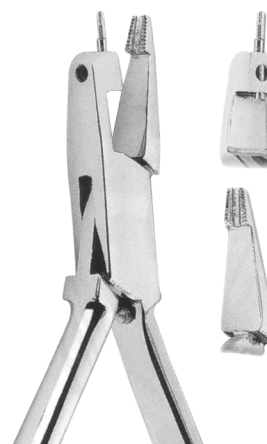

SS-7-5126
Tweed

Tweed Loop Forming Pliers. For making perfect Omega Loops with round or rectangular wires up to 0,56 x 0,7 mm. (.022" x .028"). The concave beak is exactly the same as pliers 5809-1

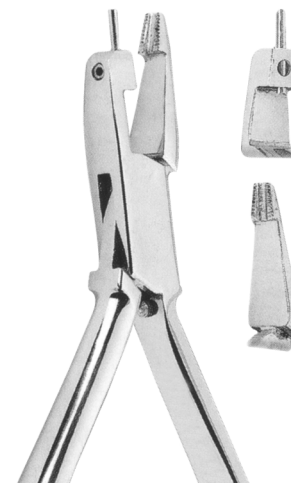

SS-7-5127
Tweed

Single diameter loop forming pliers. Wire up to 0,56 x 0,7 mm. (.022" x 0.28"). Replaceable concave beak has only one diameter section of 1,50 mm. (.059").

Distal end cutters



SS-7-5128

Distal end cutter -safety hold- a precision cutter designed for distal arch cutting in the patient's mouth. It cuts hard wires end holds the loose distal end preventing any damaging of oral tissue. Maximum cutting capacity rectangular wires up to 0,56 x 0,7 mm. (.022" x .020").



SS-7-5129

Micro- distal end cutter - safety hold-. Similar to 3227



SS-7-5130

Direct bonding bracket remover (wide). The removal grip firmly for easy incisal-gingival (vertical) use or, if needed, for mesial-distal (horizontal) use with the same ease.

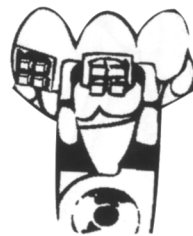

SS-7-5131

Direct bond attachment remover (angled). For removing all bonded attachments. May be used mesial-distal-horizontal) or incisal-gingival (vertical) in anterior areas. Angled perfectly for easy access to difficult posterior areas.

Bird beak pliers



SS-7-5132
Wire bending pliers. For wires up to 0,9 mm. (.036").

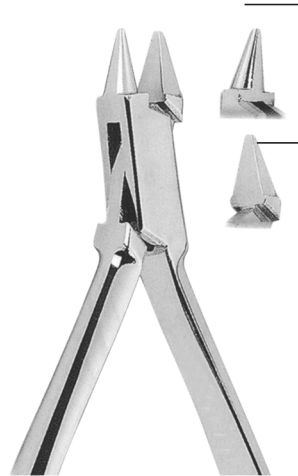

SS-7-5133
Bird Beak Angle pliers for bending round, square or rectangular wire up to 0,7 mm. (.028").



SS-7-5134
Double rounded jaw wire bending pliers. For wires up to 0,7 mm. (.028").



SS-7-5135
Bird beak pliers for bending round, square or rectangular wire up to 0,7 mm. (.028"). With cutter.

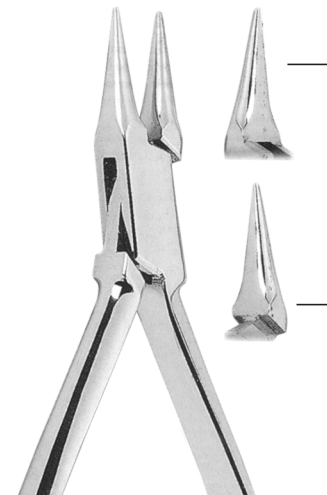

SS-7-5136
Double rounded jaw wire bending pliers. For wires up to 0,7 mm. (.028").



SS-7-5137
USA Model
125 mm



SS-7-5138
Waldron
125 mm

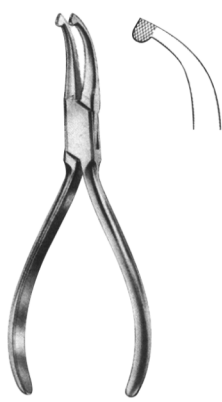

SS-7-5139
How
140 mm



SS-7-5140
How
145 mm

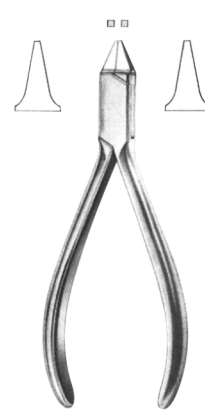

SS-7-5141
Adams
125 mm

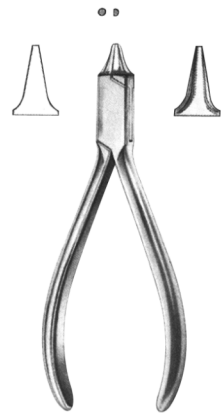

SS-7-5142
Angle
125 mm



SS-7-5143
young
130 mm

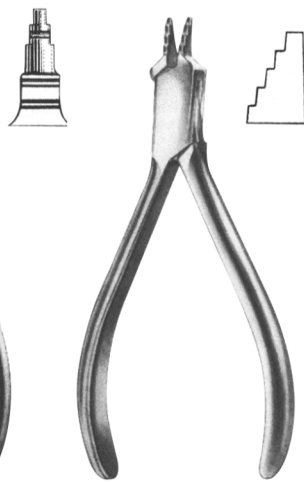

SS-7-5144
Nance
130 mm



SS-7-5145
Weingart
140 mm

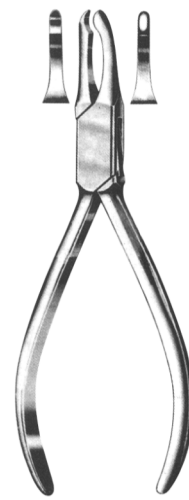

SS-7-5146
Johnson
130 mm



SS-7-5147
Mc Kellops
155 mm

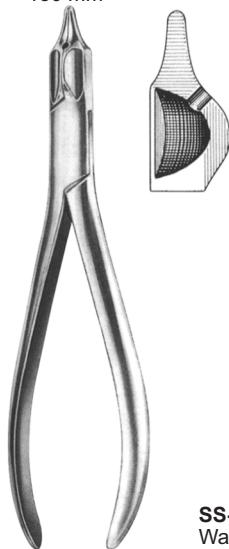

SS-7-5148
Universal
150 mm

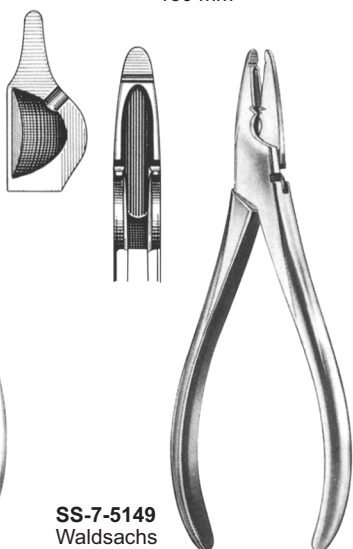

SS-7-5149
Waldsachs
155 mm

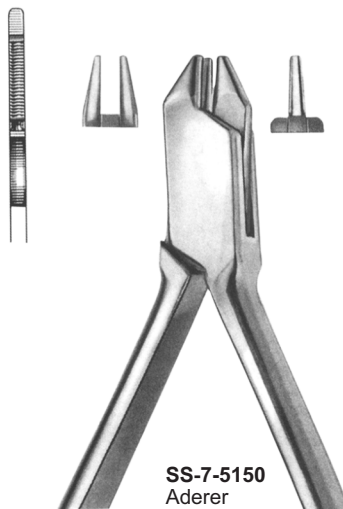

SS-7-5150
Aderer
125 mm



SS-7-5151
Nance
130 mm



SS-7-5152
Langenbeck
140 mm



SS-7-5153
Langenbeck
130 mm



SS-7-5154
Langenbeck
130 mm



SS-7-5155
Peeso
125 mm



SS-7-5156
Goslee
125 mm

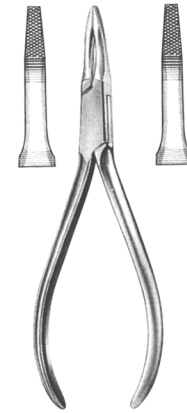

SS-7-5157
Fischer
140 mm

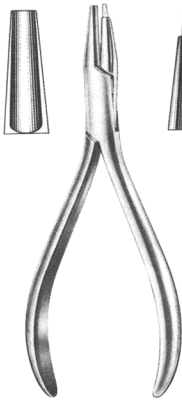

SS-7-5158
Andresen
130 mm

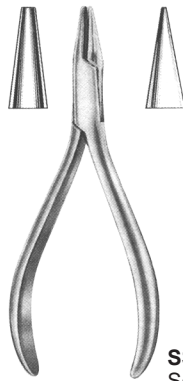

SS-7-5159
Schwarz
130 mm

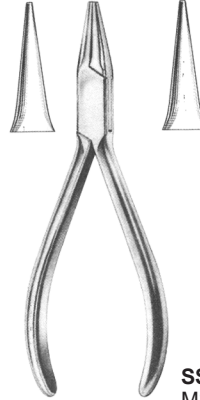

SS-7-5160
MSY
130 mm

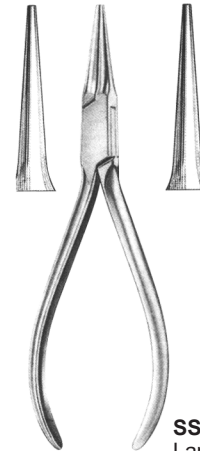

SS-7-5161
Langenbeck
125 mm



SS-7-5162

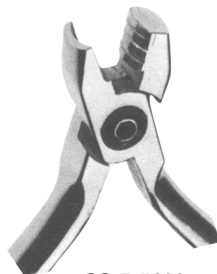

SS-7-5163



SS-7-5164



SS-7-5165



SS-7-5166

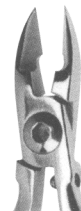

SS-7-5167



SS-7-5168



SS-7-5169

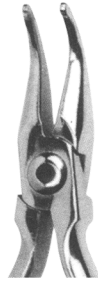

SS-7-5170

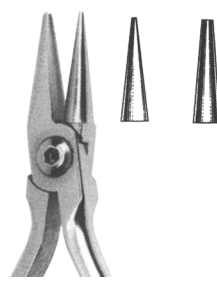

SS-7-5171

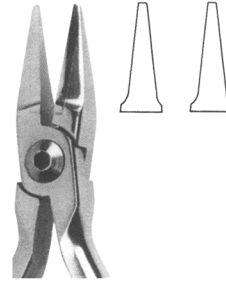

SS-7-5172

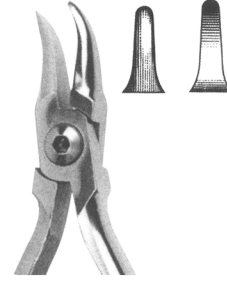

SS-7-5173

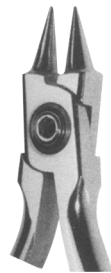

SS-7-5174

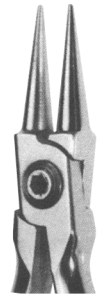

SS-7-5175

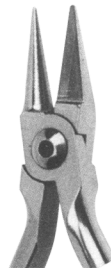

SS-7-5176

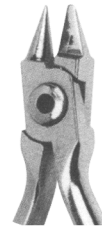

SS-7-5177



SS-7-5178

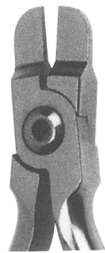

SS-7-5179

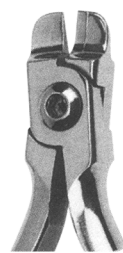

SS-7-5180

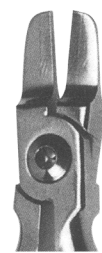

SS-7-5181

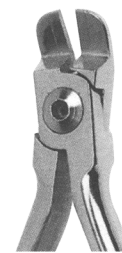

SS-7-5182

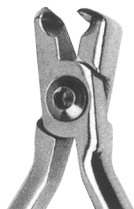

SS-7-5183

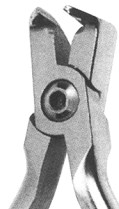

SS-7-5184

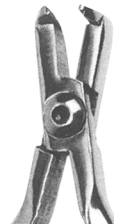

SS-7-5185

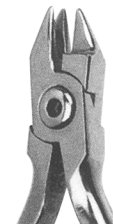

SS-7-5186



Molt
SS-7-5187 10 cm
SS-7-5188 11 cm
SS-7-5189 14 cm



SS-7-5190 16 cm
SS-7-5191 19 cm
 Roser-König

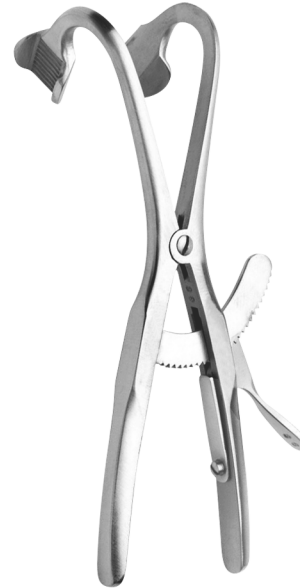

SS-7-5192
 Denhardt
 13 cm



SS-7-5193
 Fergusson - Ackland
 14.5 cm



SS-7-5194
 Heister
 Maunder Wood
 9.5 cm



SS-7-5195
 Obwegeser 11 cm
 Spreading 47 mm



SS-7-5196
 Heister
 13 cm



SS-7-5197 Small
SS-7-5198 Medium
SS-7-5199 Large
 Cheek Retractor

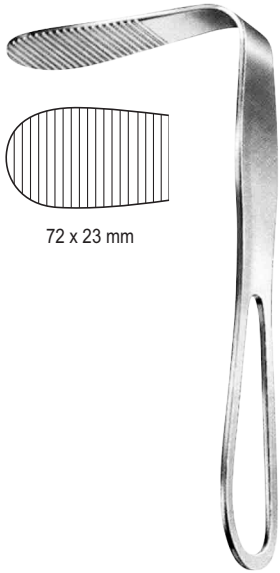

72 x 23 mm

SS-7-5200
Hartmann
15 cm



SS-7-5201
Doyen Tongue Spatula
13.5 cm



SS-7-5202
14.5 cm



SS-7-5203
18 cm



SS-7-5204
Bruenings
19 cm

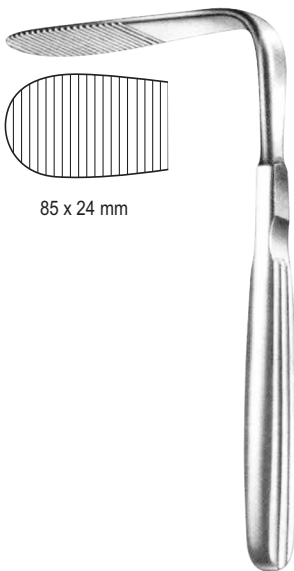

85 x 24 mm

SS-7-5205
Tobold
15 cm

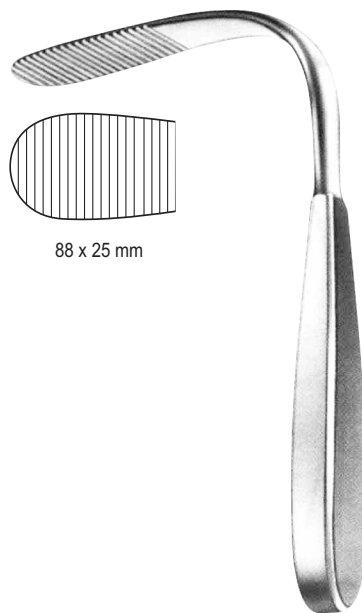

88 x 25 mm

SS-7-5206
Tobold
16 cm

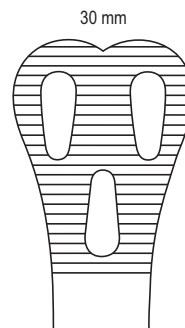

SS-7-5207
14 cm

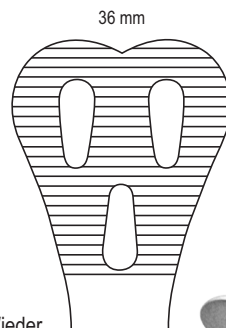

SS-7-5208
15 cm

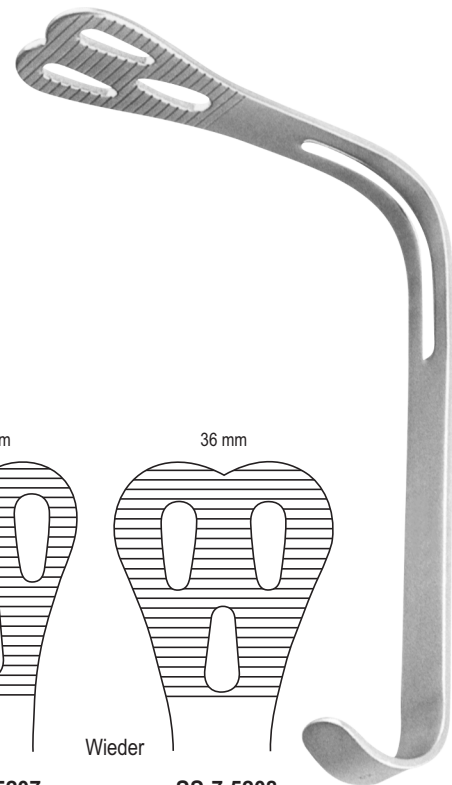

Wieder

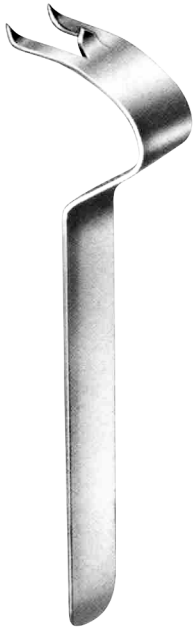

SS-7-5209
Obwegeser Chin
Retractor
16.5 cm



Obwegeser 16 cm
SS-7-5210 8 mm
SS-7-5211 10 mm



SS-7-5212 43 x 11 mm
SS-7-5213 57 x 11 mm
SS-7-5214 83 x 16 mm

35 x 11 mm



SS-7-5215
Obwegeser
ramus retractor
22 cm



72 x 11 mm

SS-7-5216
Obwegeser
Ramus retractor for
separation of ramus & tissue
22 cm



SS-7-5217
Simplex
10.5 cm

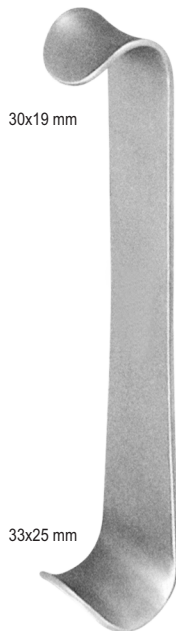

30x19 mm

33x25 mm

SS-7-5218
Kilner
15 cm



SS-7-5219
Minnesota
14 cm



SS-7-5220
Cawood-Minnesota
15 cm



SS-7-5221
Austin



SS-7-5222
Hilger
Fits any simple stem mouth mirror handle

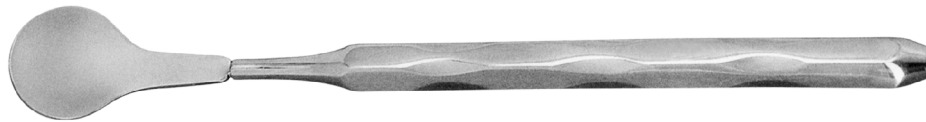

SS-7-5223
Hilger
with handle

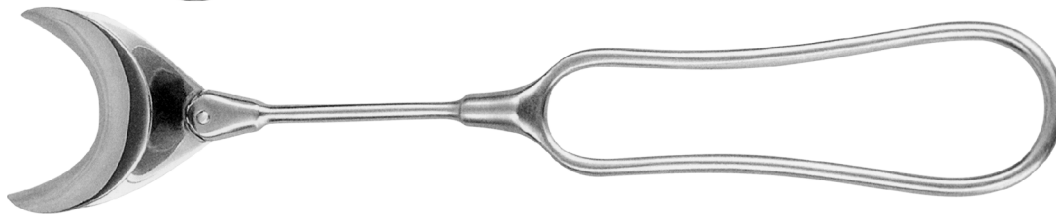

SS-7-5224
Max
20 cm

Finger protectors



Langenbeck

SS-7-5225 Small
SS-7-5226 Medium
SS-7-5227 Large

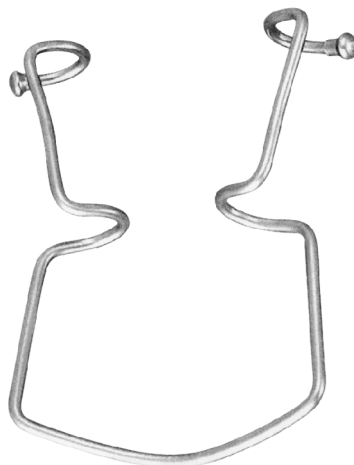

SS-7-5228
Oringer
11.5 cm

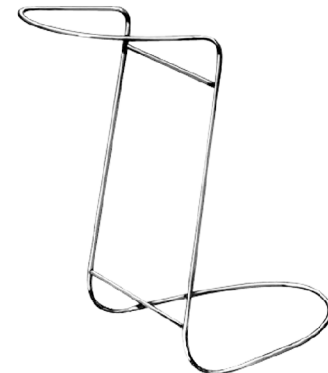

SS-7-5229
Obwegeser Cheek Retractor
12cm

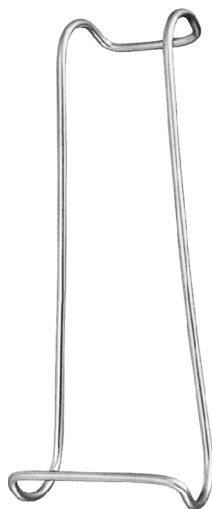

SS-7-5230
Columbia
14.5 cm



Sternberg

SS-7-5231 12 cm
SS-7-5232 14 cm
SS-7-5233 15 cm



Vestibulum
SS-7-5234



SS-7-5235
Max

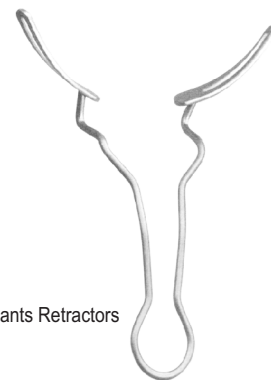

Implants Retractors

SS-7-5236
Max

Retractors

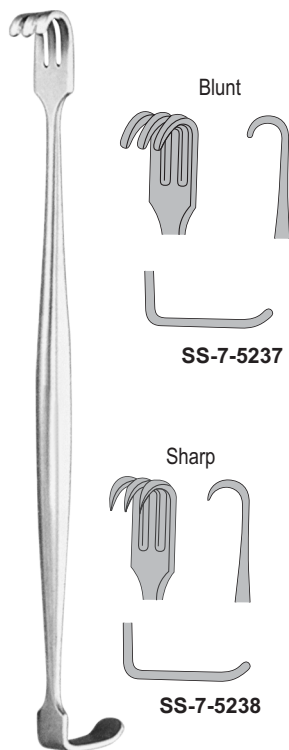

Blunt

SS-7-5237

Sharp

SS-7-5238

Senn-Miller
16 cm



Sharp

SS-7-5239

SS-7-5240

SS-7-5241

SS-7-5242

Max
16 cm



Blunt

SS-7-5243

SS-7-5244

SS-7-5245

SS-7-5246

Max
16 cm

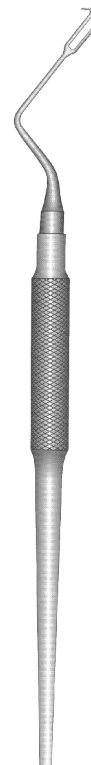

Kirkland
Gum & Tissue
Retractors

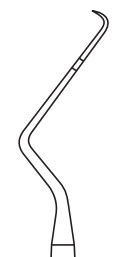

SS-7-5247
Fig. 23 K



SS-7-5248
Fig. 24 K



SS-7-5249
Fig. 27 K



SS-7-5250
Fig. 28 K



SS-7-5251
Collin Tongue holding forceps
17 cm



SS-7-5254
Rubber Pad pair

Young Tongue holding forceps
SS-7-5252 15 cm
SS-7-5253 17 cm

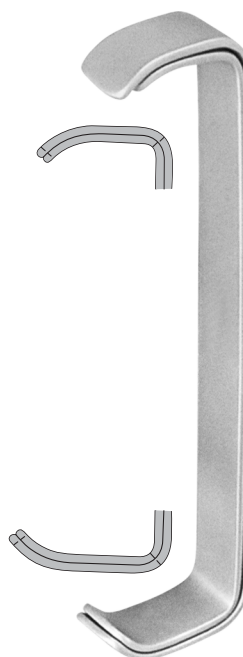

SS-7-5255
Farabeuf 12 cm
Pair



SS-7-5256
Parker-Langenbeck 21 cm
Pair

Osteotomes



15.5 cm

# 1	Diam.
0	Ø 1.60
7.5	Ø 1.80
10	Ø 2.00
13.5	Ø 2.40
15.5	Ø 3.60

1
Ø 1.6 mm



SS-7-5257
15.5 cm

# 2	Diam.
0	Ø 1.90
7.5	Ø 2.20
10	Ø 2.35
13.5	Ø 3.30
15.5	Ø 3.40
23.5	Ø 4.50

2
Ø 1.9 mm



SS-7-5258
15.5 cm

# 3	Diam.
0	Ø 2.80
7.5	Ø 3.20
10.5	Ø 3.35
13.5	Ø 3.60
21	Ø 4.40

3
Ø 2.8 mm



SS-7-5259
15.5 cm

# 4	Diam.
0	Ø 3.10
7.5	Ø 3.70
10.5	Ø 3.90
15.5	Ø 4.30

4
Ø 3.10 mm



SS-7-5260
15.5 cm

# 5	Diam.
0	Ø 3.90
10	Ø 5.00
13	Ø 5.20
20.5	Ø 6.30

5
Ø 3.90 mm



SS-7-5261
15.5 cm

# 6	Diam.
0	Ø 5.50
10	Ø 6.20
13	Ø 6.30

6
Ø 5.50 mm



SS-7-5262
15.5 cm

# 1	Diam.
0	Ø 1.50
5	Ø 1.90
8	Ø 2.20
10	Ø 2.40
12	Ø 2.60
14	Ø 2.80

1
Ø 1.5 mm



SS-7-5263
15.5 cm

# 2	Diam.
0	Ø 2.10
5	Ø 2.60
8	Ø 2.80
10	Ø 3.00
12	Ø 3.20
14	Ø 3.40

2
Ø 2.1 mm



SS-7-5264
15.5 cm

# 3	Diam.
0	Ø 2.60
5	Ø 3.00
8	Ø 3.30
10	Ø 3.50
12	Ø 3.70
14	Ø 3.90

3
Ø 2.6 mm



SS-7-5265
15.5 cm

# 4	Diam.
0	Ø 3.00
5	Ø 3.50
8	Ø 3.80
10	Ø 4.00
12	Ø 4.20
14	Ø 4.40

4
Ø 3.0 mm



SS-7-5266
15.5 cm

# 5	Diam.
0	Ø 3.50
5	Ø 3.90
8	Ø 4.20
10	Ø 4.40
12	Ø 4.60
14	Ø 4.80

5
Ø 3.5 mm



SS-7-5267
15.5 cm

Ø 2.8 mm



SS-7-5268
15.5 cm

Ø 3.5 mm



SS-7-5269
15.5 cm

Ø 4.2 mm



SS-7-5270
15.5 cm

Spelling Straight
Bone Pusher

Osteotomes

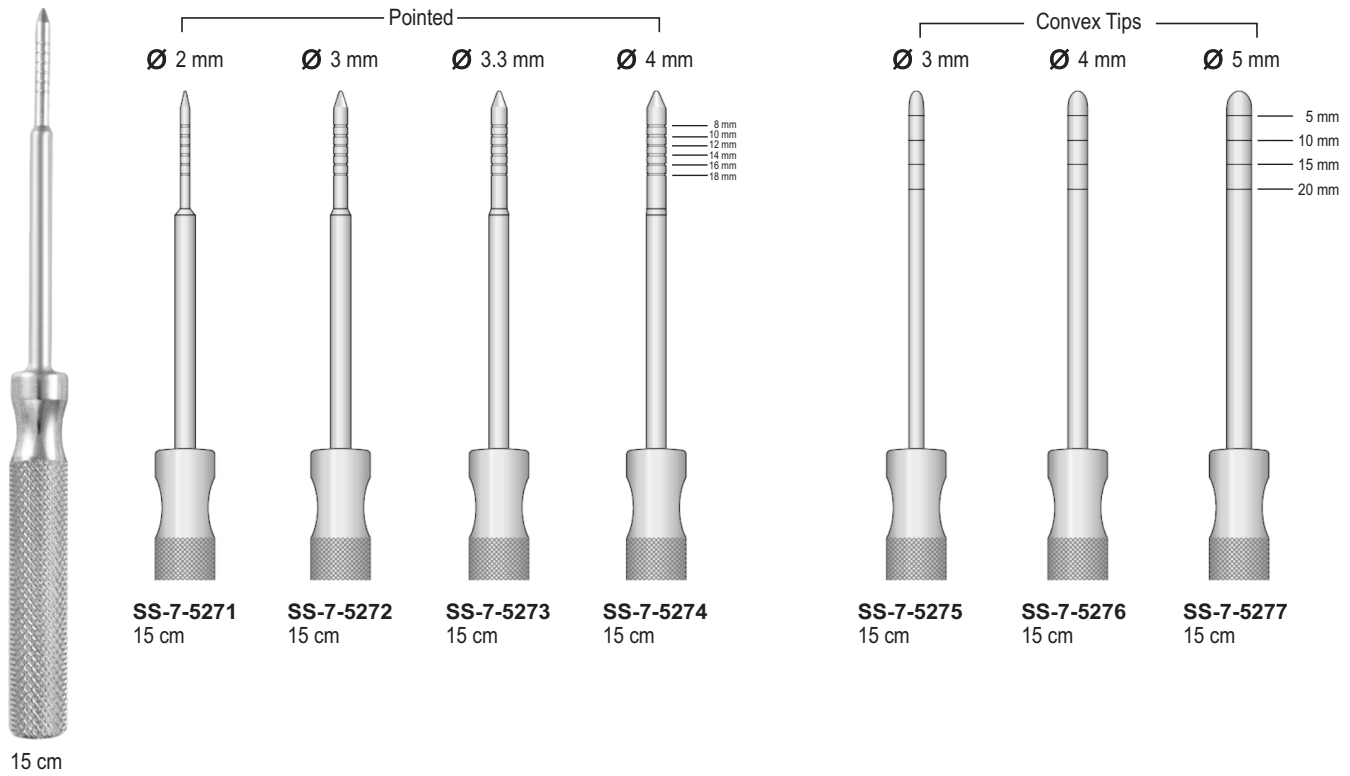

Convex Tips

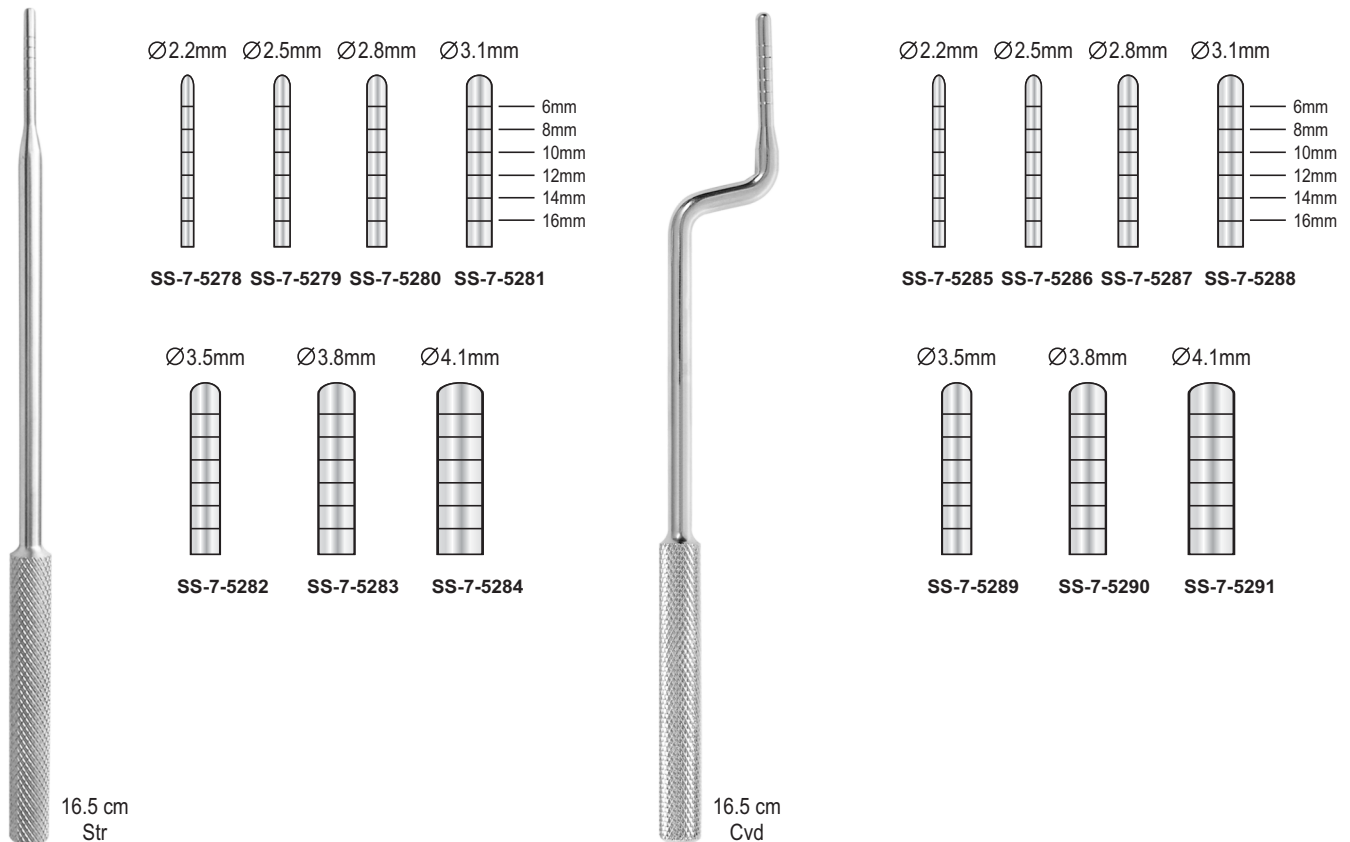

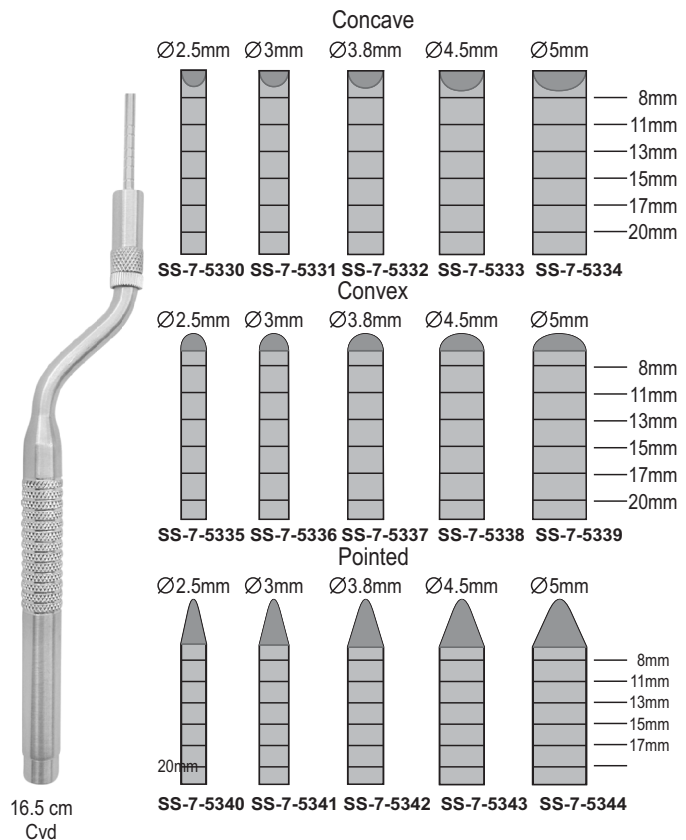
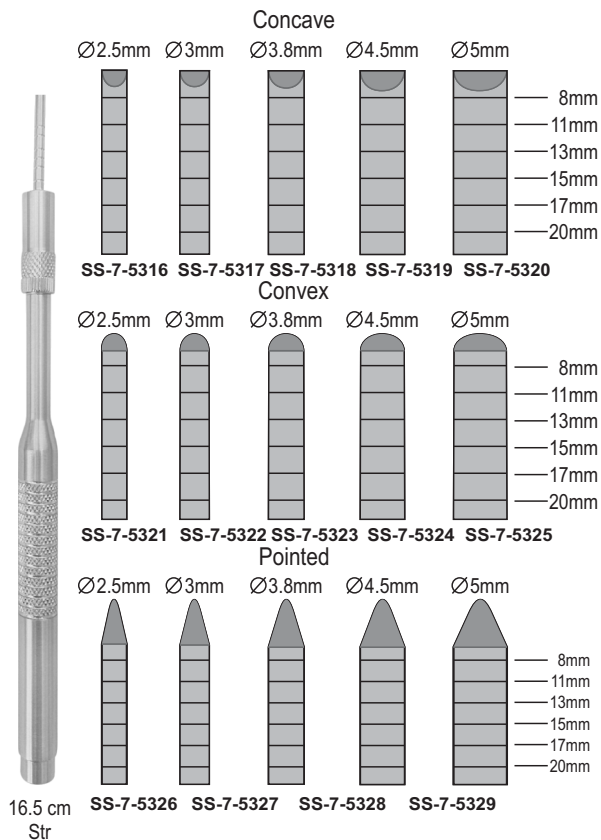
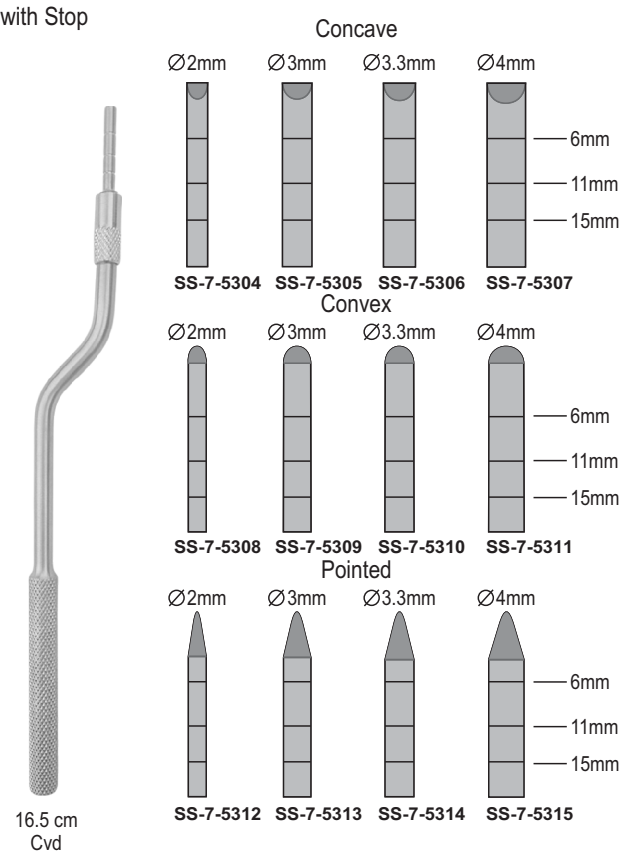
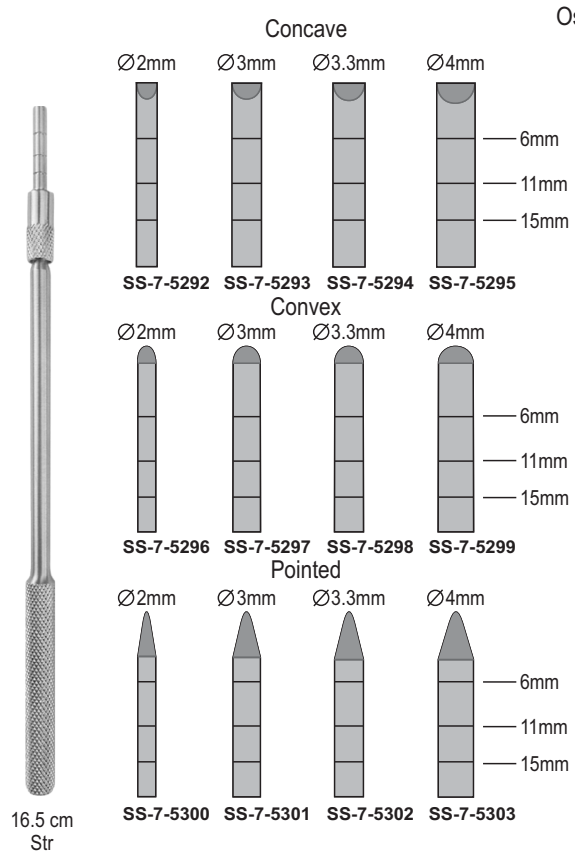

PDL Elevators



SS-7-5345 Distal, 2.5 mm Micro Edge



SS-7-5346 Mesial, 2.5 mm Micro Edge



SS-7-5347 Distal, 4 mm Micro Edge



SS-7-5348 Mesial 4 mm Micro Edge



SS-7-5349 2.5 mm Micro Edge, Straight



SS-7-5350 2.5 mm Micro Edge, Curved



SS-7-5351 3.4 mm

Straight **SS-7-5352** Set

Of 7 Pieces



SS-7-5353 Distal, 2.5 mm Micro Edge



SS-7-5354 Mesial, 2.5 mm Micro Edge



SS-7-5355 Distal, 4 mm Micro Edge



SS-7-5356 Mesial 4 mm Micro Edge



SS-7-5357 2.5 mm Micro Edge, Straight



SS-7-5358 2.5 mm Micro Edge, Curved



SS-7-5359 3.4 mm Straight

SS-7-5360 Set Of 7 Pieces



Instruments Tray

Trephine Drills



SS-7-5361
Interior 2 mm
Exterior 3 mm



SS-7-5362
Interior 3 mm
Exterior 4 mm



SS-7-5363
Interior 4 mm
Exterior 5 mm



SS-7-5364
Interior 5 mm
Exterior 6 mm



SS-7-5365
Interior 6 mm
Exterior 7 mm



SS-7-5366
Interior 7 mm
Exterior 8 mm



SS-7-5367
Interior 8 mm
Exterior 9 mm



SS-7-5368
Interior 9 mm
Exterior 10 mm



SS-7-5369
Trephine Drills Stand
Complete with drills



SS-7-5370
Trephine Drills Stand
Complete with drills

Tissue Punches



SS-7-5371
2 mm

SS-7-5372
3 mm

SS-7-5373
4 mm

SS-7-5374
5 mm

SS-7-5375
6 mm

SS-7-5376
7 mm

SS-7-5377
8 mm



SS-7-5378
3 mm

SS-7-5379
4 mm

SS-7-5380
5 mm

SS-7-5381
6 mm

Keyes

Keyes

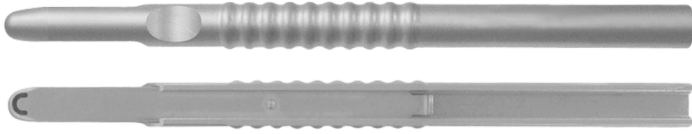

SS-7-5382
Bone Collector Chisel Straight



SS-7-5383
Blade for Straight bone collector chisel



SS-7-5384
Bone Collector Chisel Curved



SS-7-5385
Blade for Curved bone collector chisel



SS-7-5386
Ratchet Screw driver handle
Hexagonal head



SS-7-5387
Bone Morselizer with Titanium Grinding



SS-7-5388
Bone Mixing Basin
Dia 35 mm



SS-7-5389
Manual Easy Bone Mill



SS-7-5390
Bone Craker Titanium

WE HAVE ALL RANGE OF INSTRUMENTS



CONTACT INFO



+92-340 0473111



swisons.ind@gmail.com



www.swisons.com



Small Industrial Estate, Sialkot 51310 Pakistan

Get your high quality Instruments