

# SWISONS

SURGICALS

- Self- Retaining Retractors
- Abdominal Retractors

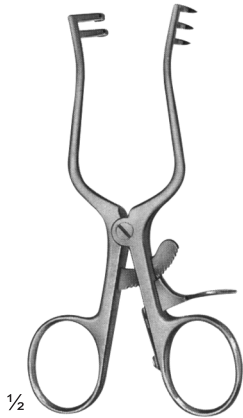



**SS-04-101**  
WEITLANER  
Sharp  
110 mm

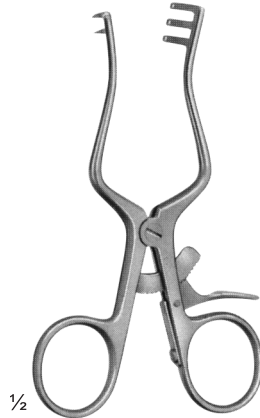

**SS-04-102**  
WEITLANER  
Semi-Sharp  
110 mm



**SS-04-103**  
WEITLANER  
Blunt  
110 mm



**SS-04-104**  
WEITLANER  
Sharp  
130 mm



**SS-04-105**  
WEITLANER  
Semi-Sharp  
130 mm

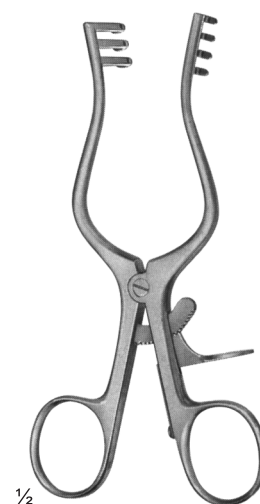

**SS-04-106**  
WEITLANER  
Blunt  
130 mm

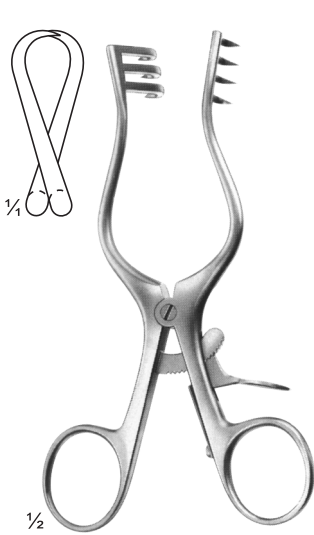

**SS-04-107**  
WEITLANER  
Sharp  
130 mm

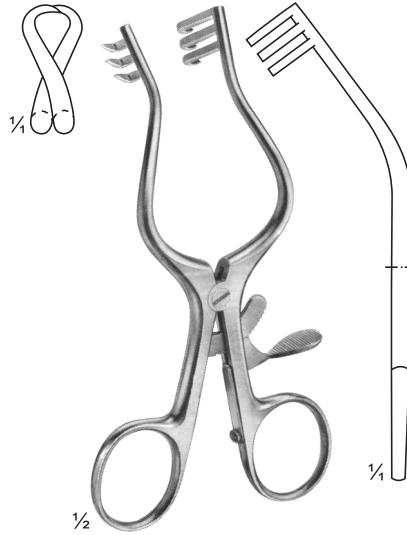

**SS-04-108**  
WULLSTEIN  
Sharp  
130 mm

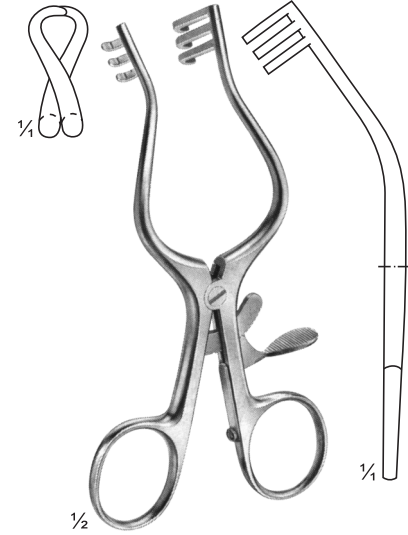

**SS-04-109**  
WULLSTEIN  
Blunt  
130 mm

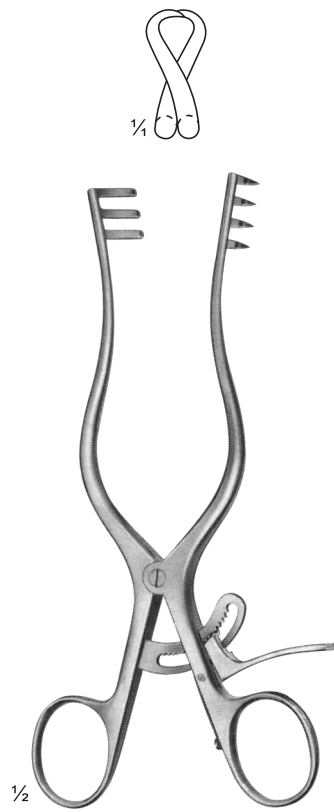

**SS-04-110**  
WEITLANER  
Sharp  
165 mm



**SS-04-111**  
PLESTER  
Blunt  
110 mm

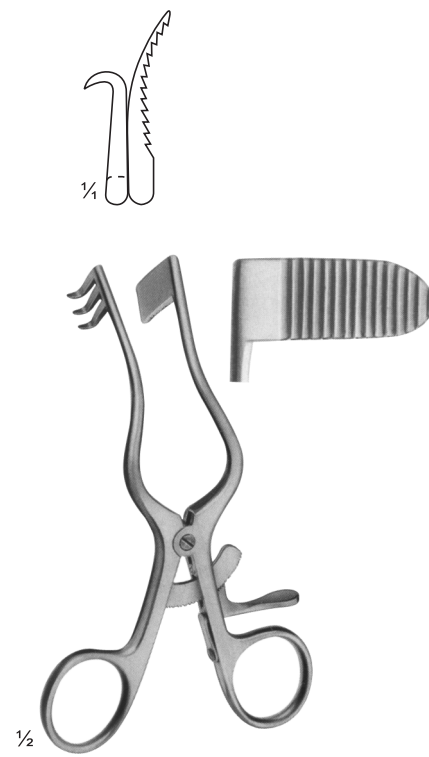

**SS-04-112**  
PERKINS  
Blunt  
130 mm



SS-04-113  
ADSON-BABY  
Blunt  
140 mm

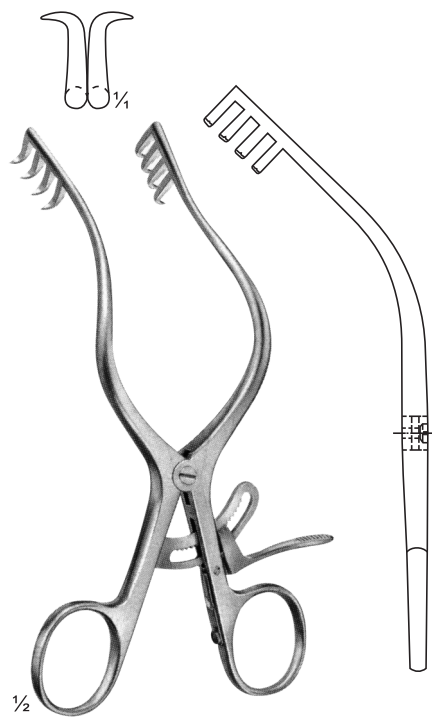

SS-04-114  
MOLLISON  
Sharp  
155 mm

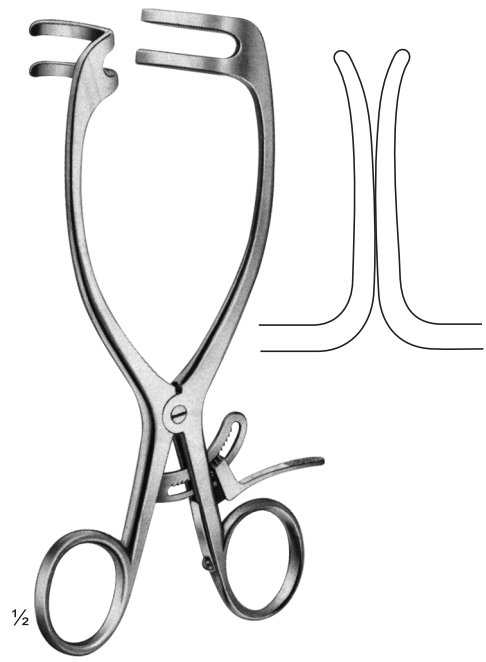

SS-04-115  
MAYO-ADAMS  
165 mm

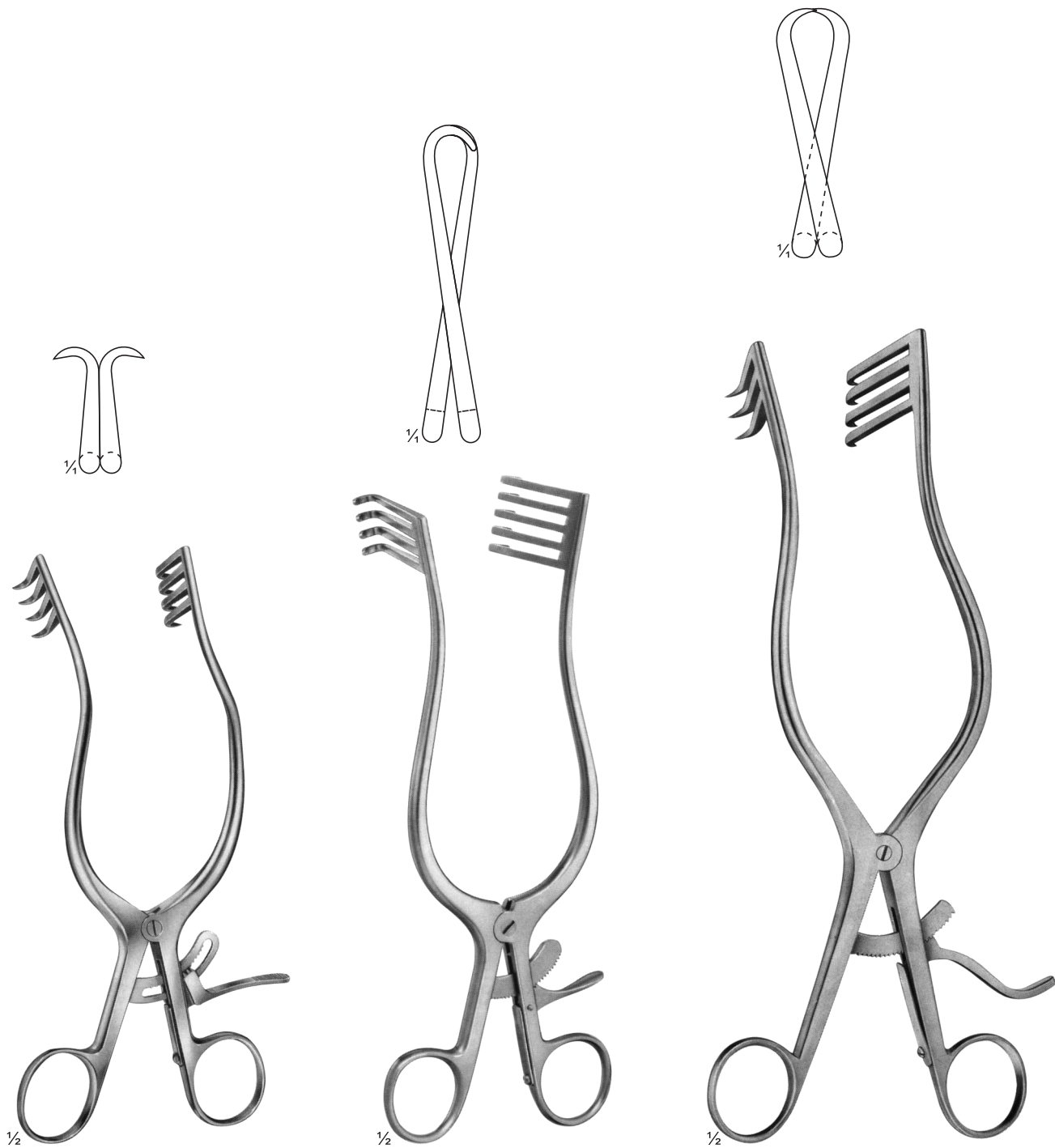

**SS-04-116**  
ANDERSON-ADSON  
Sharp  
190 mm

**SS-04-117**  
NORFOLK and  
NORWICH  
Blunt  
220 mm

**SS-04-118**  
ADSON  
Sharp  
265 mm

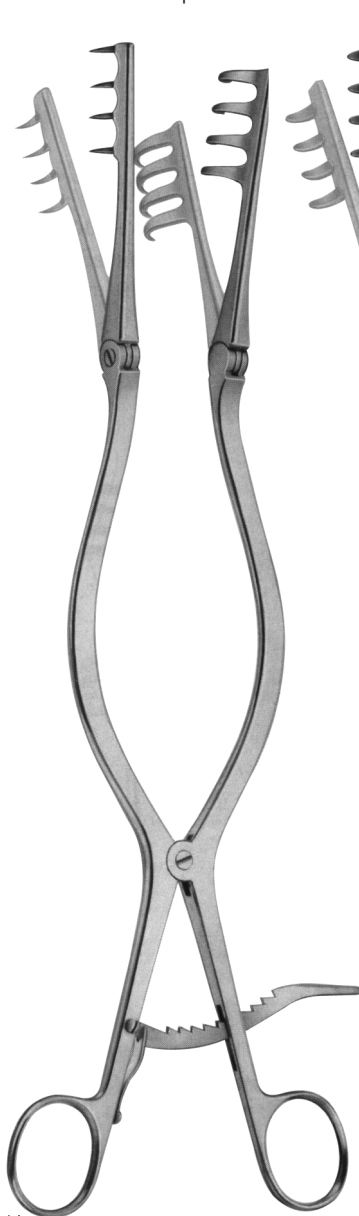
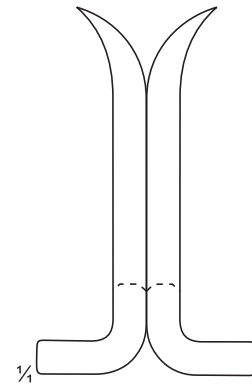
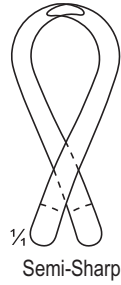
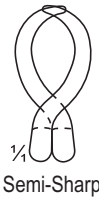
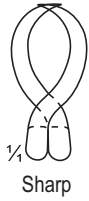

1/2  
**SS-04-119**  
BECKMANN-ADSON  
Sharp  
310 mm



**SS-04-119A**  
BECKMANN-ADSON  
Semi-Sharp  
310 mm



1/2  
**SS-04-120**  
ADSON  
Semi-Sharp  
320 mm



1/2  
**SS-04-121**  
BECKMANN-EATON  
Sharp  
320 mm

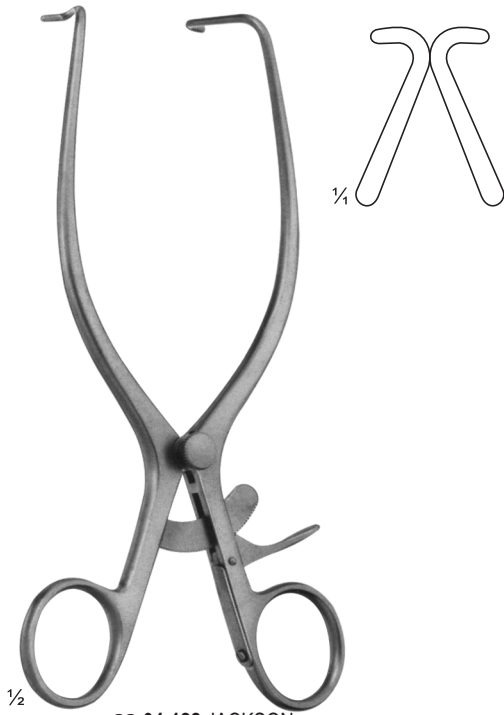

SS-04-122 JACKSON  
BURROWS Retractor,  
blunt  
185 mm



SS-04-123  
GELPI  
Vaginal Retractor  
135 mm



SS-04-124  
GELPI  
Skin- and Vaginal Retractor  
175 mm



SS-04-125  
DE BAKEY  
Femur Retractor  
145 mm

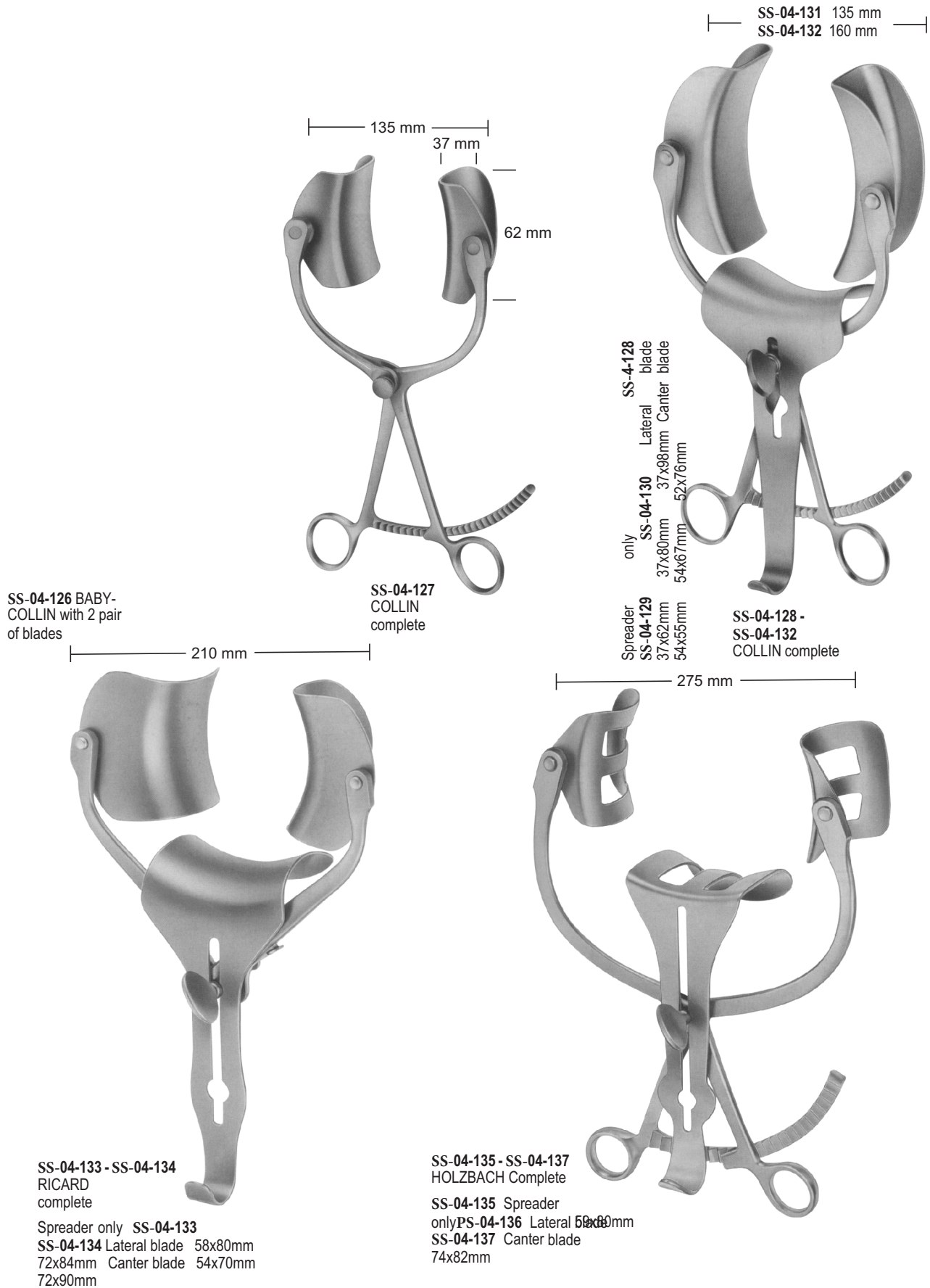



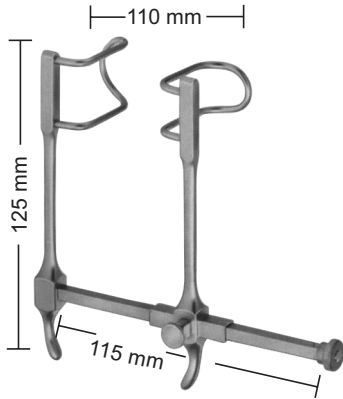

**SS-04-138**  
GOSSET  
Blades:38 mm deep

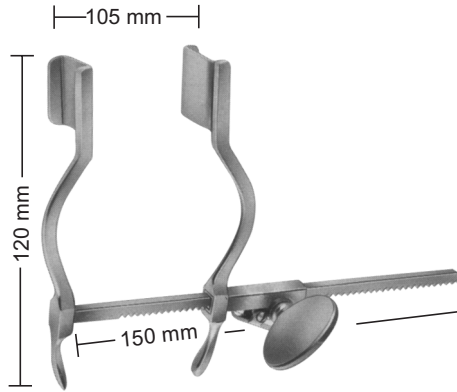

**SS-04-139**  
HERTZLER Blades  
20 X 25 mm

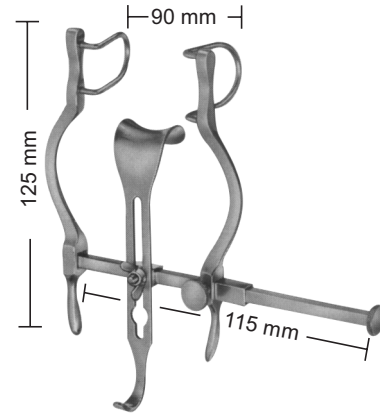

**SS-04-140**  
BALFOUR-BABY  
Lateral blades 27 mm deep  
Center blade 21x24 mm

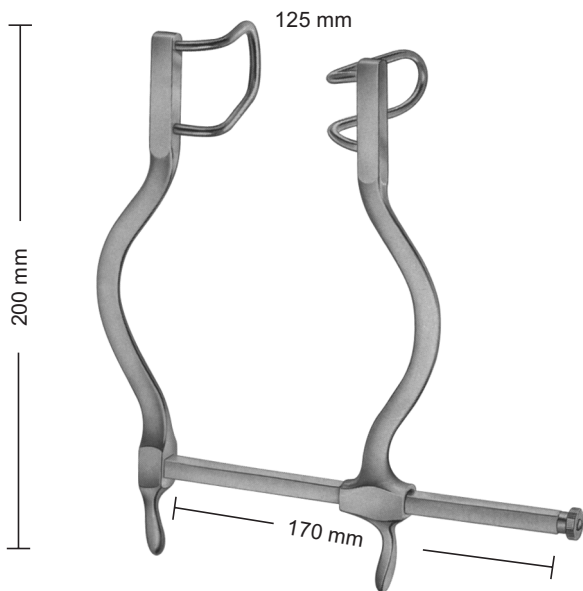

**SS-04-141**  
GOSSET  
Blades:55mm deep

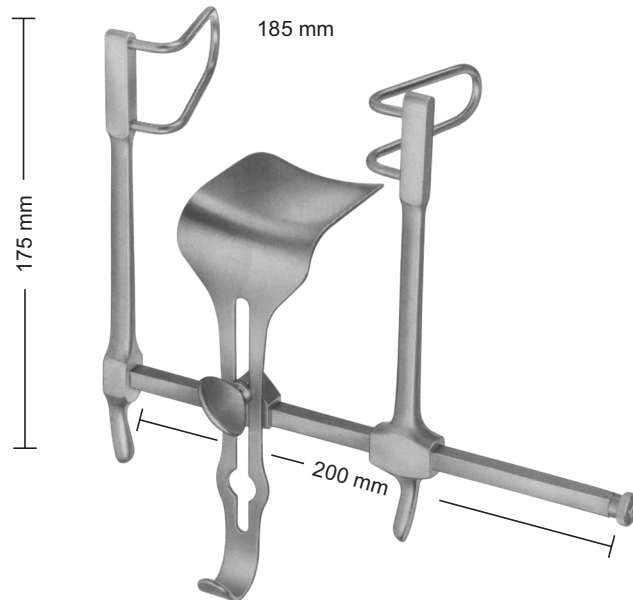

**SS-04-142**  
GOSSET  
Lateral blades 58 mm deep  
Center blade 59 x 57 mm

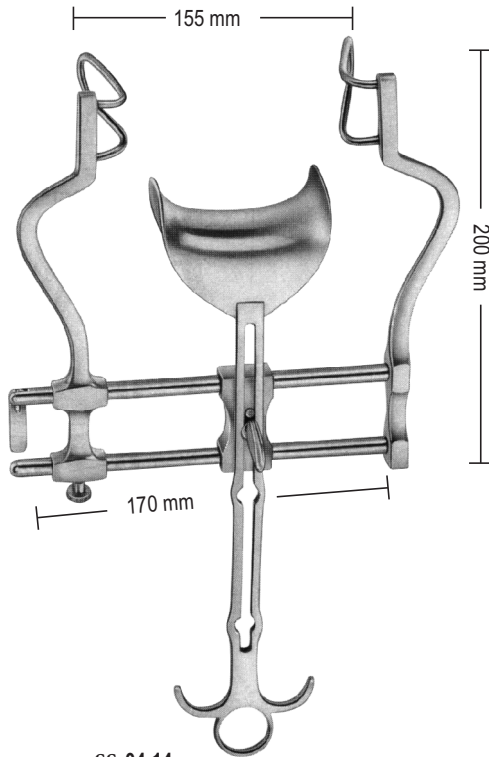

**SS-04-14**  
**3**  
 Balfour  
 Lateral blades 60 mm deep  
 Center blade 47 x 80 mm

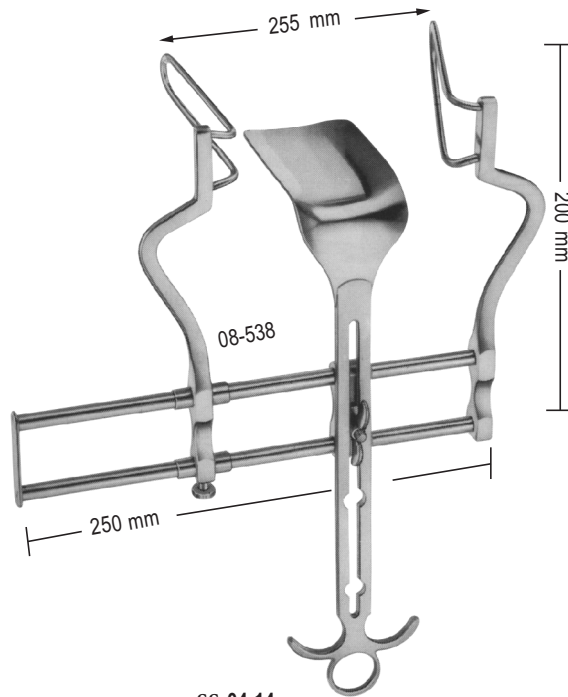

**SS-04-14**  
**4**  
 Balfour  
 Lateral blades 105 mm deep  
 Center blade 107x 59 mm

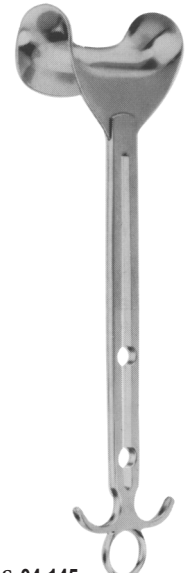

**SS-04-145**  
 Center blade only  
 54x80 mm

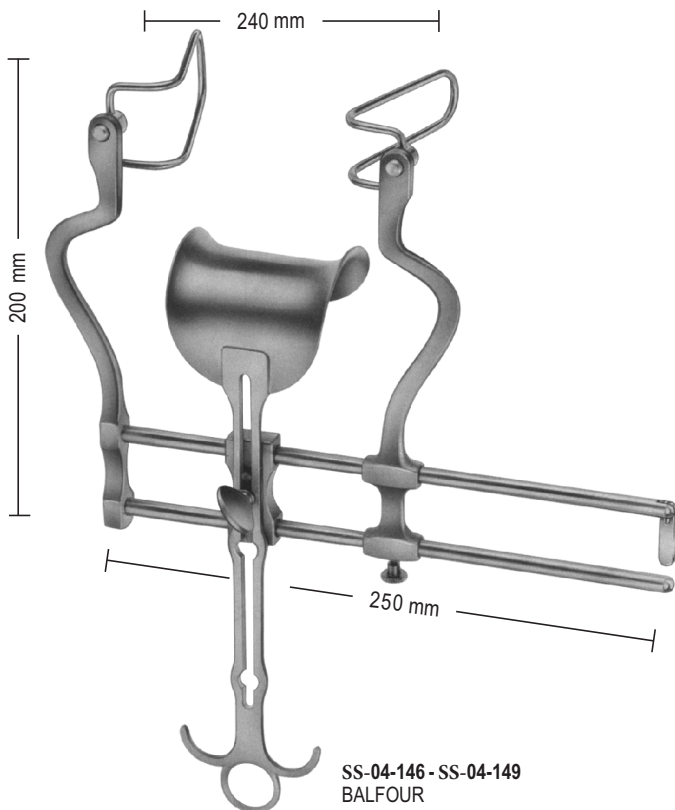

**SS-04-146 - SS-04-149**  
 BALFOUR  
 Spreader only  

Lateral blades	50 mm	60 mm	75 mm	90 mm
Center blade	47 x 80 mm	62x76 mm	80x80 mm	80x80 mm

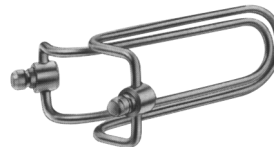

Sales Unit of blades:PR = pair

Lateral blades  
**SS-04-150**  
 50 mm deep  
**SS-04-151**  
 60 mm deep  
**SS-04-152**  
 75 mm deep  
**SS-04-153**  
 90 mm deep



BOSE  
SS-04-154  
60 mm



FINSEN  
SS-04-155  
50 mm



FINSEN  
SS-04-156  
70 mm



FINSEN modif.  
SS-04-157  
75 mm



SS-04-158  
45 mm



SS-04-159  
55 mm



MUELLER  
SS-04-160  
65 mm

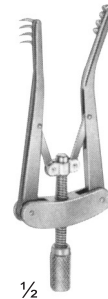

ALM  
SS-04-161 7 cm  
SS-04-162 10 cm



SS-04-161



SS-04-162

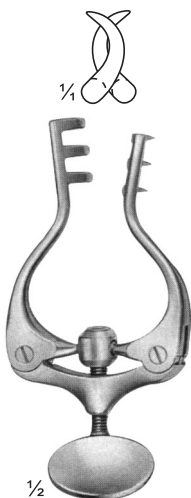

JANSEN  
SS-04-163  
100 mm

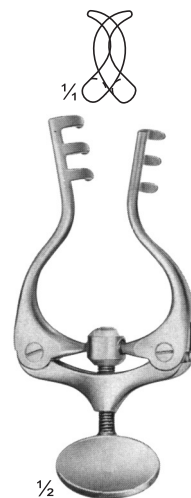

JANSEN  
SS-04-164  
100 mm

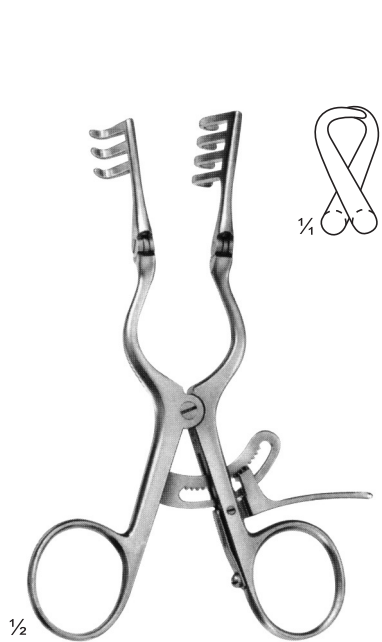

ADSON-BABY  
Blunt  
SS-04-165  
14 cm

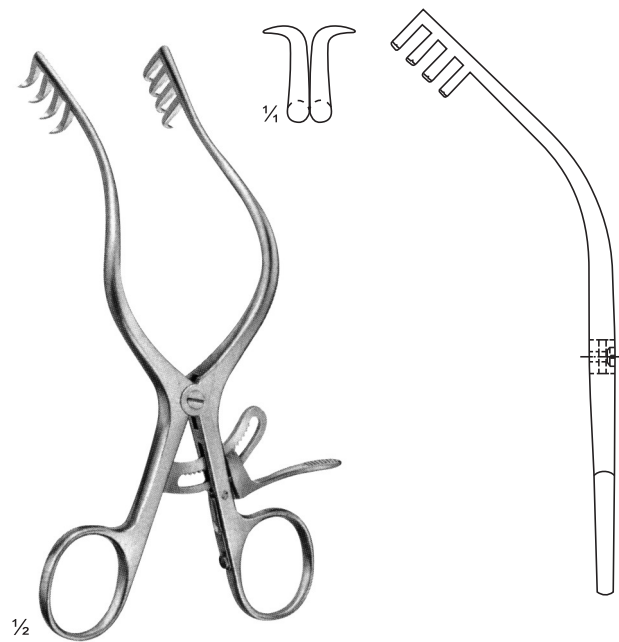

MOLLISON  
Sharp  
SS-04-166  
15.5 cm

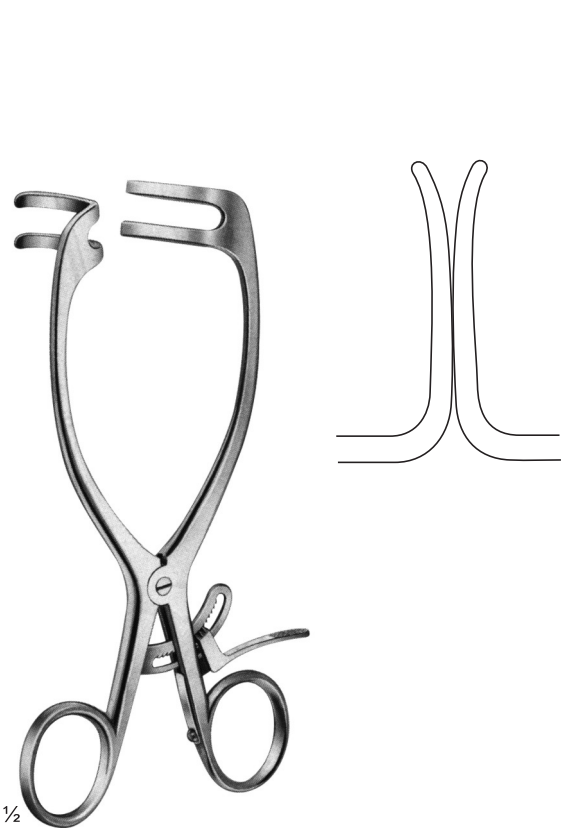

MAYO-ADAMS  
SS-04-167  
16.5 cm



TRAVERS  
SS-04-168  
21.5 cm

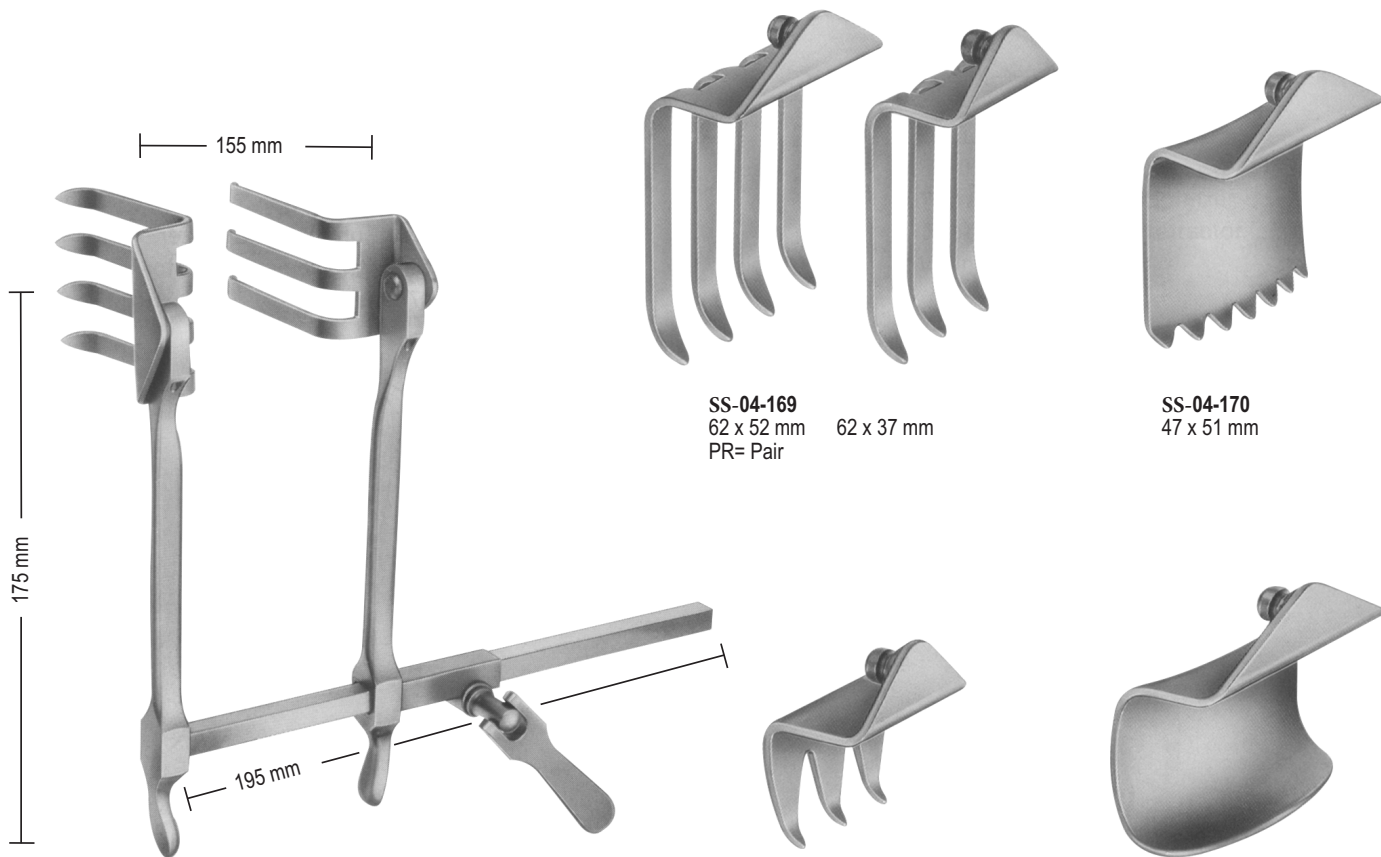

**SS-04-169**  
62 x 52 mm 62 x 37 mm  
PR= Pair

**SS-04-170**  
47 x 51 mm

**SS-04-169 -  
SS-04-172 SCOVILLE-  
RICHTER Retractor**  
with 1 pair blades  
reversible type. The  
Retractor bar and  
shanks may be easily  
rotated 180 when  
blades are in situ.

**SS-04-171**  
30 x 40 mm

**SS-04-172**  
37 x 62 mm

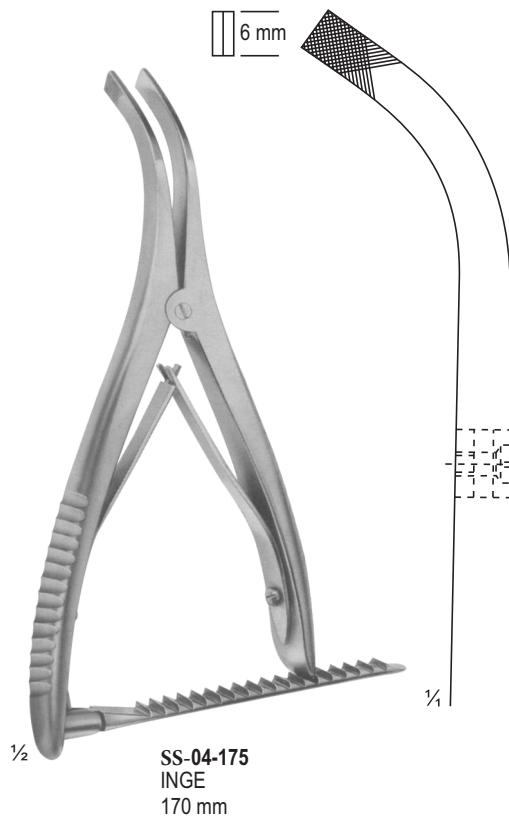
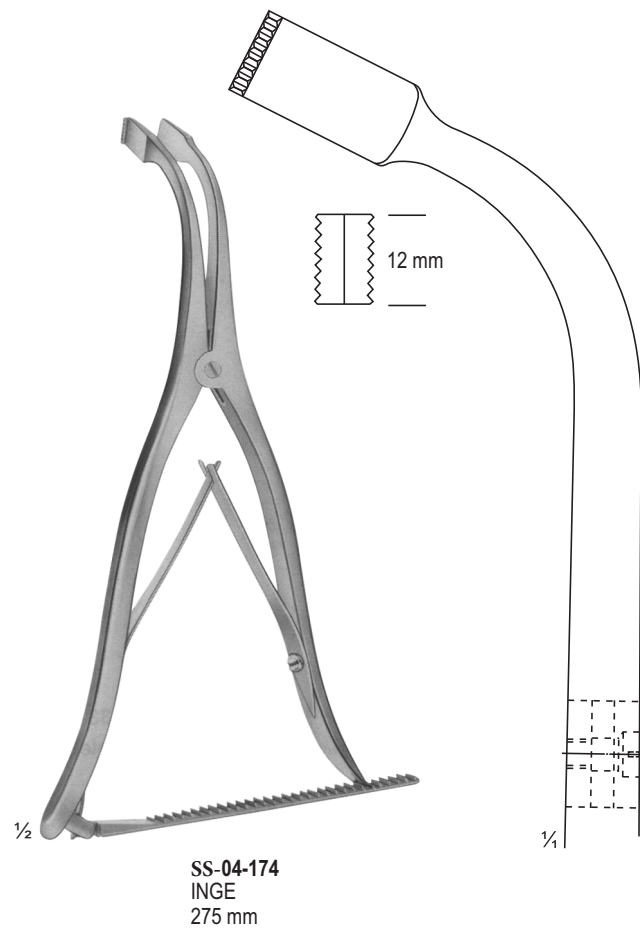
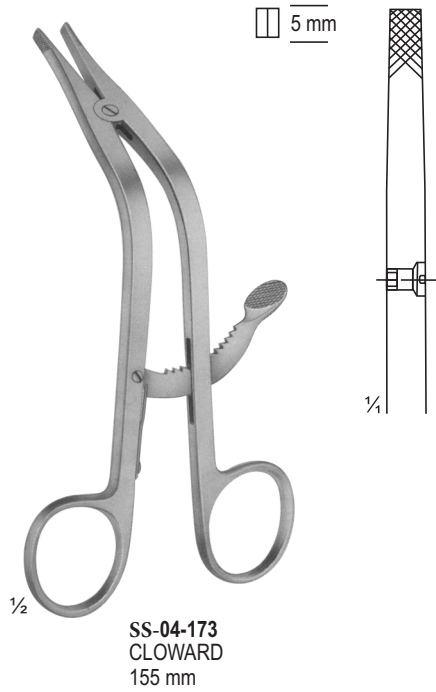

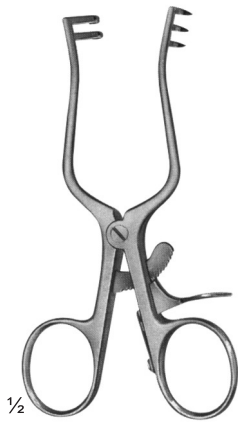

WEITLANER  
Sharp  
SS-04-176  
11 cm

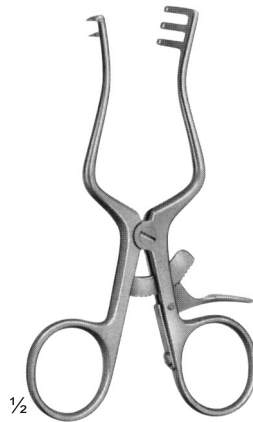

WEITLANER  
Semi-Sharp  
SS-04-177  
11 cm



WEITLANER  
Blunt  
SS-04-178  
11 cm



WEITLANER  
Sharp  
SS-04-179  
13 cm

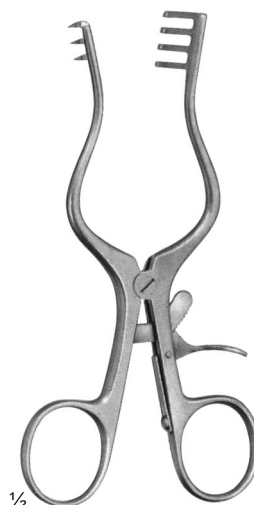

WEITLANER  
Semi-Sharp  
SS-04-180  
13 cm

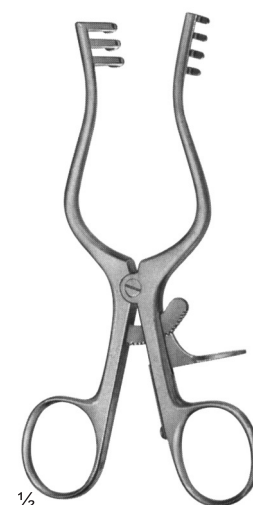

WEITLANER  
Blunt  
SS-04-181  
13 cm

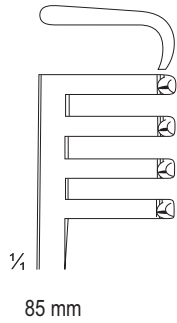

HENLEY  
Complete with 3 Central Baldes  
SS-04-182 - SS-04-184 16.5  
cm

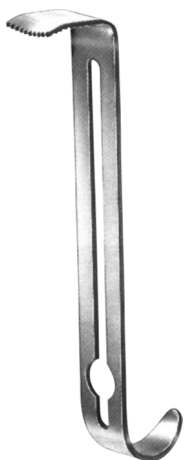

Blades  
SS-04-182  
19 X 17 mm

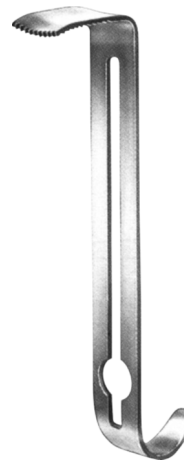

Blades  
SS-04-183  
25 X 17 mm

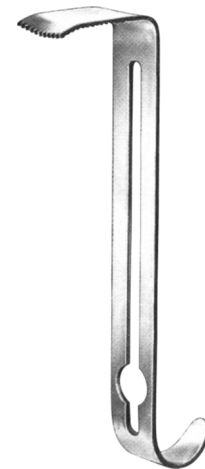

Blades  
SS-04-184  
32 X 17 mm





JOLL ( FRIEDMAN )  
**SS-04-185**  
 Thyroid and Vaginal Retractor  
 15.5 cm

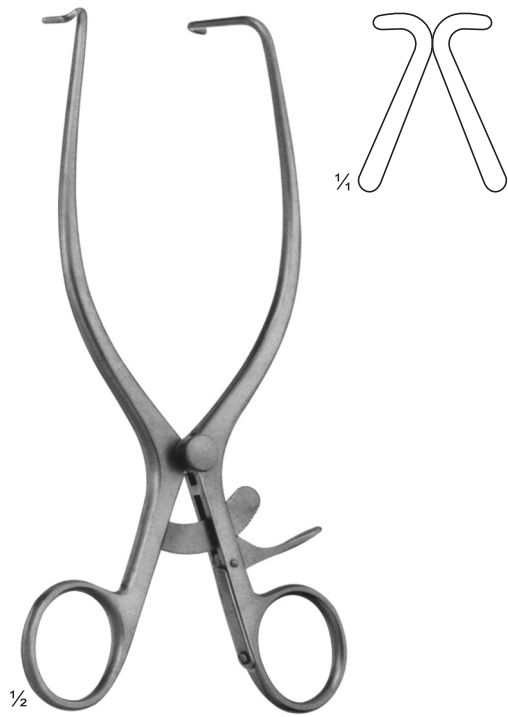

JACKSON BURROWS  
**SS-04-186** Retractor,  
 blunt  
 18.5 cm

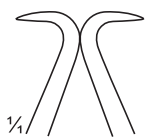

GELPI  
**SS-04-187**  
 13.5 cm

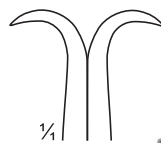

GELPI  
**SS-04-188**  
 17.5 cm

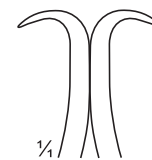

DE BAKEY  
**SS-04-189**  
 14.5 cm

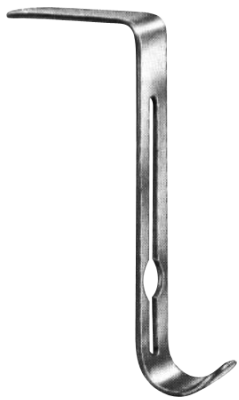

1



2



3

Blades for  
Fig. 1 = SS-04-190 45 X 17 mm Fig. 2 =  
SS-04-191 90 X 37 mm Fig. 3 = SS-04-192 90 X  
45 mm



CLOWARD modif.  
Spreader Only  
SS-04-193 -  
SS-04-202

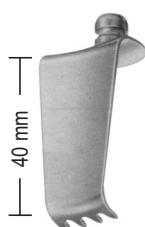

16 mm  
SS-04-193

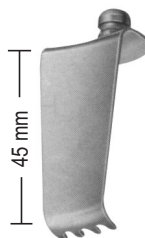

16 mm  
SS-04-194

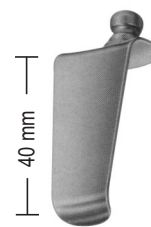

16 mm  
SS-04-195

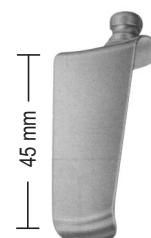

16 mm  
SS-04-196

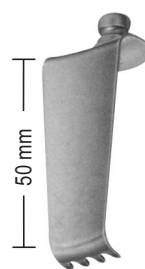

16 mm  
SS-04-197

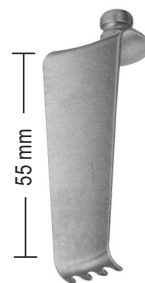

16 mm  
SS-04-198

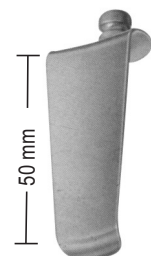

16 mm  
SS-04-199

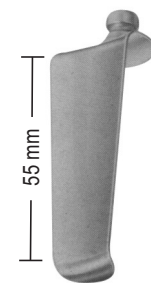

16 mm  
SS-04-200

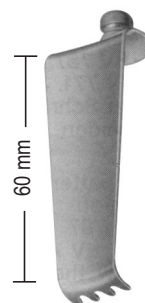

16 mm  
SS-04-201

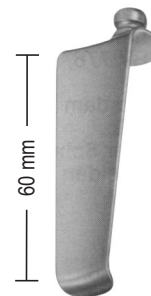

16 mm  
SS-04-202



CLOWARD-TYPE  
**SS-04-203**  
 25.5 cm  
 with ball snap closure Cervical Retractor  
 complete consisting of Retractor Body  
 25.5 cm, 110 mm spread (without blades)



**SS-04-204 - SS-04-208**  
**SS-04-204** 15 x 40 mm  
**SS-04-205** 15 x 45 mm  
**SS-04-206** 15 x 50 mm  
**SS-04-207** 15 x 55 mm  
**SS-04-208** 15 x 60 mm  
 serrated



**SS-04-209 - SS-04-213**  
**SS-04-209** 15 x 40 mm  
**SS-04-210** 15 x 45 mm  
**SS-04-211** 15 x 50 mm  
**SS-04-212** 15 x 55 mm  
**SS-04-213** 15 x 60 mm  
 Blunt

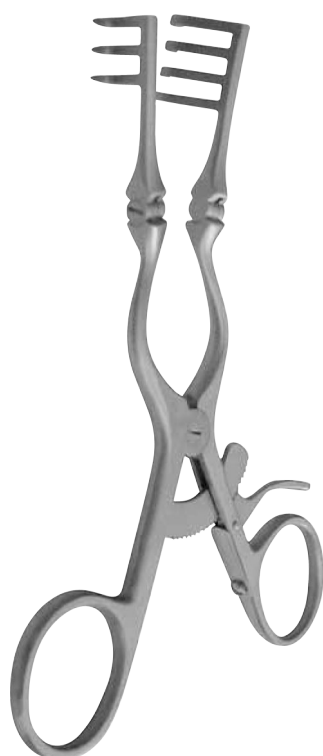

CONE  
**SS-04-214 - SS-04-221**  
**SS-04-214** 14 cm, 18 mm 3 x 4  
**SS-04-215** 16 cm, 18 mm 3 x 4  
**SS-04-216** 20 cm, 20 mm 3 x 4  
**SS-04-217** 24 cm, 27 mm 3 x 4  
**SS-04-218** 14 cm, 18 mm 3 x 4  
**SS-04-219** 16 cm, 18 mm 3 x 4  
**SS-04-220** 20 cm, 20 mm 3 x 4  
**SS-04-221** 24 cm, 27 mm 3 x 4  
 prongs blunt



MARKHAM-MEYERDING  
**SS-04-222**  
 18 cm, 50 x 25 mm left  
 Hemilaminectomy Retractor



MARKHAM-MEYERDING  
**SS-04-223**  
 18 cm, 50 x 25 mm right  
 Hemilaminectomy Retractor



**MINI-WEITLANER**

**SS-04-224 - SS-04-225**

**SS-04-224** 11 cm, 16 mm 2 x 3 prongs sharp

**SS-04-225** 11 cm, 16 mm 2 x 3 prongs blunt



**WEITLANER**

**SS-04-226 - SS-04-233**

**SS-04-226** 13 cm, 18 mm 3 x 4 prongs sharp

**SS-04-227** 16 cm, 18 mm 3 x 4 prongs sharp

**SS-04-228** 20 cm, 21 mm 3 x 4 prongs sharp

**SS-04-229** 25 cm, 27 mm 3 x 4 prongs sharp

**SS-04-230** 13 cm, 18 mm 3 x 4 prongs blunt

**SS-04-231** 16 cm, 18 mm 3 x 4 prongs blunt

**SS-04-232** 20 cm, 21 mm 3 x 4 prongs blunt

**SS-04-233** 25 cm, 27 mm 3 x 4 prongs blunt



**ANDERSON-ADSON**

**Cerebellar Retractor**

**SS-04-234** 20 cm 4 x 4 prongs sharp



WEITLANER  
**SS-04-235 - SS-04-236**  
**SS-04-235** 26 cm, 27 mm 5 x 6 prongs sharp  
**SS-04-236** 26 cm, 27 mm 5 x 6 prongs blunt



HEMILAMINECTOMY  
**SS-04-237 - AE-04-238**  
**AE-04-238** 29 cm, 42 mm 6 x 6 prongs sharp  
**SS-04-238** 29 cm, 42 mm 6 x 6 prongs blunt



**SS-04-239 - SS-04-242**  
 Right blade 42 mm, left blade 22 mm deep  
**SS-04-239** 29 cm, 22/42 mm 6 x 6 prongs sharp  
**SS-04-240** 29 cm, 22/42 mm 6 x 6 prongs blunt  
  
 Right blade 22 mm, left blade 42 mm deep  
**SS-04-241** 29 cm, 22/42 mm 6 x 6 prongs sharp  
**SS-04-242** 29 cm, 22/42 mm 6 x 6 prongs blunt

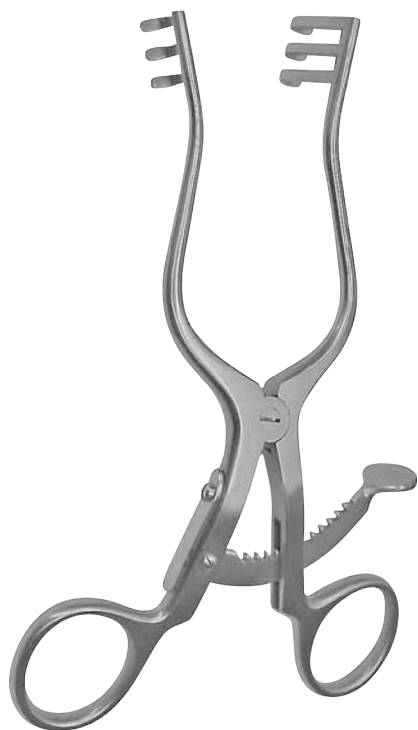

**SCALP CONTOUR**

**SS-04-243 - SS-04-246**

- SS-04-243** 14 cm, 18 mm 1 x 1 prongs blunt
- SS-04-244** 14 cm, 18 mm 3 x 3 prongs blunt
- SS-04-245** 14 cm, 18 mm 3 x 4 prongs sharp
- SS-04-246** 14 cm, 18 mm 3 x 4 prongs blunt



**BECKMANN-ADSON**

**SS-04-247 - SS-04-252**

- SS-04-247** 31 cm, 25 mm 4 x 4 prongs sharp
- SS-04-248** 31 cm, 37 mm 4 x 4 prongs sharp
- SS-04-249** 31 cm, 48 mm 4 x 4 prongs sharp
- SS-04-250** 31 cm, 25 mm 4 x 4 prongs blunt
- SS-04-251** 31 cm, 37 mm 4 x 4 prongs blunt
- SS-04-252** 31 cm, 48 mm 4 x 4 prongs blunt

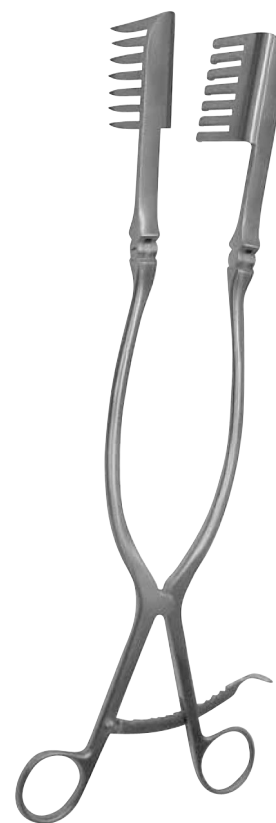

**BECKMANN-EATON**

**SS-04-253**

- 32 cm, 50 mm 7 x 7 prongs sharp



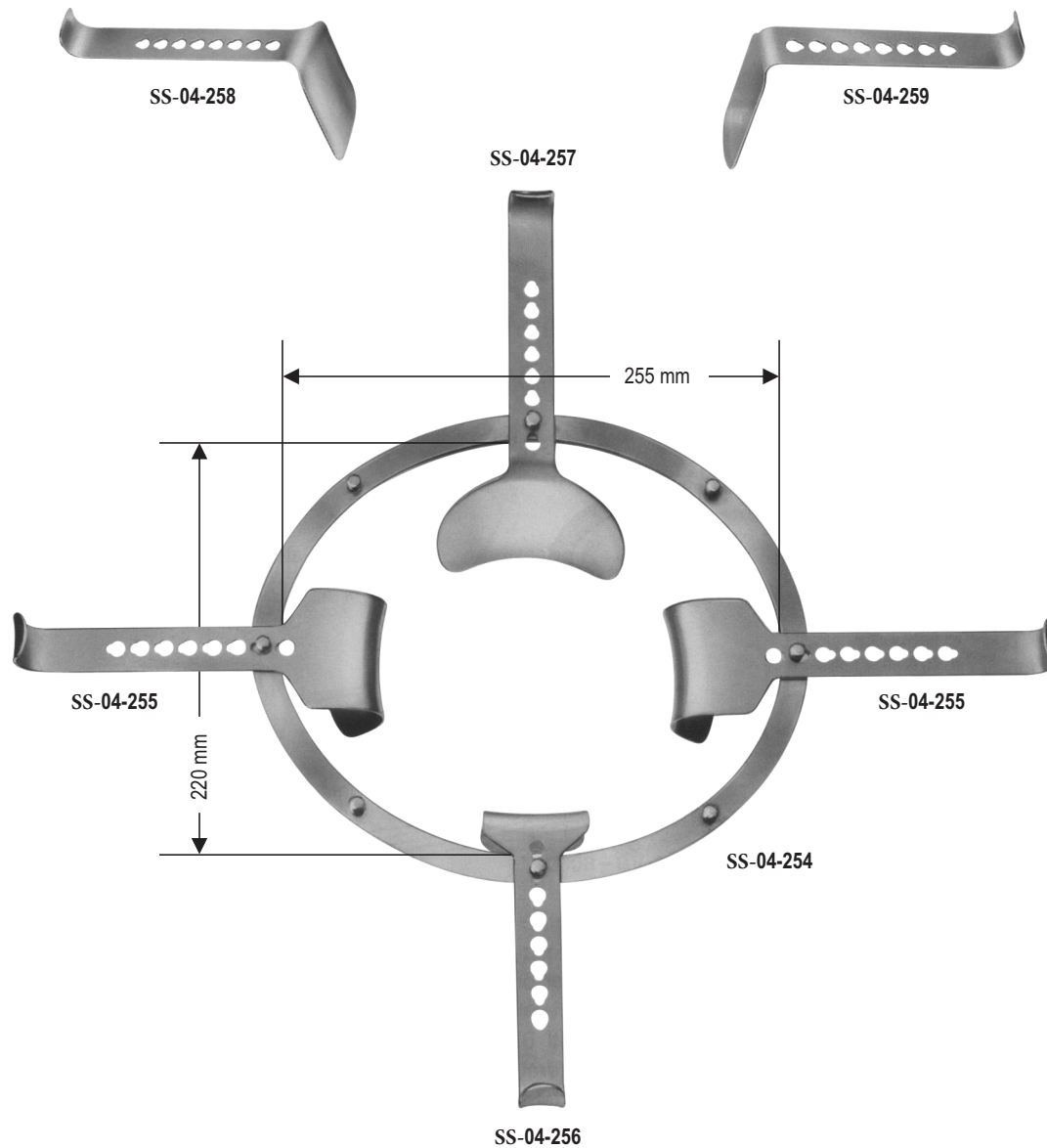

**SS-04-254 - SS-04-259**

SEMM

consisting of:

**SS-04-254** 1 frame 225 x 220 mm

**SS-04-255** 2 blades 46 x 64 mm

**SS-04-256** 1 blade 53 x 54 mm  
(for bladder)

**SS-04-257** 1 blade 82 x 97 mm  
(for intestine)

**SS-04-258** 1 blade 98 x 51 mm  
(for intestine)

**SS-04-259** 1 blade,  
107 x 36 mm narrow

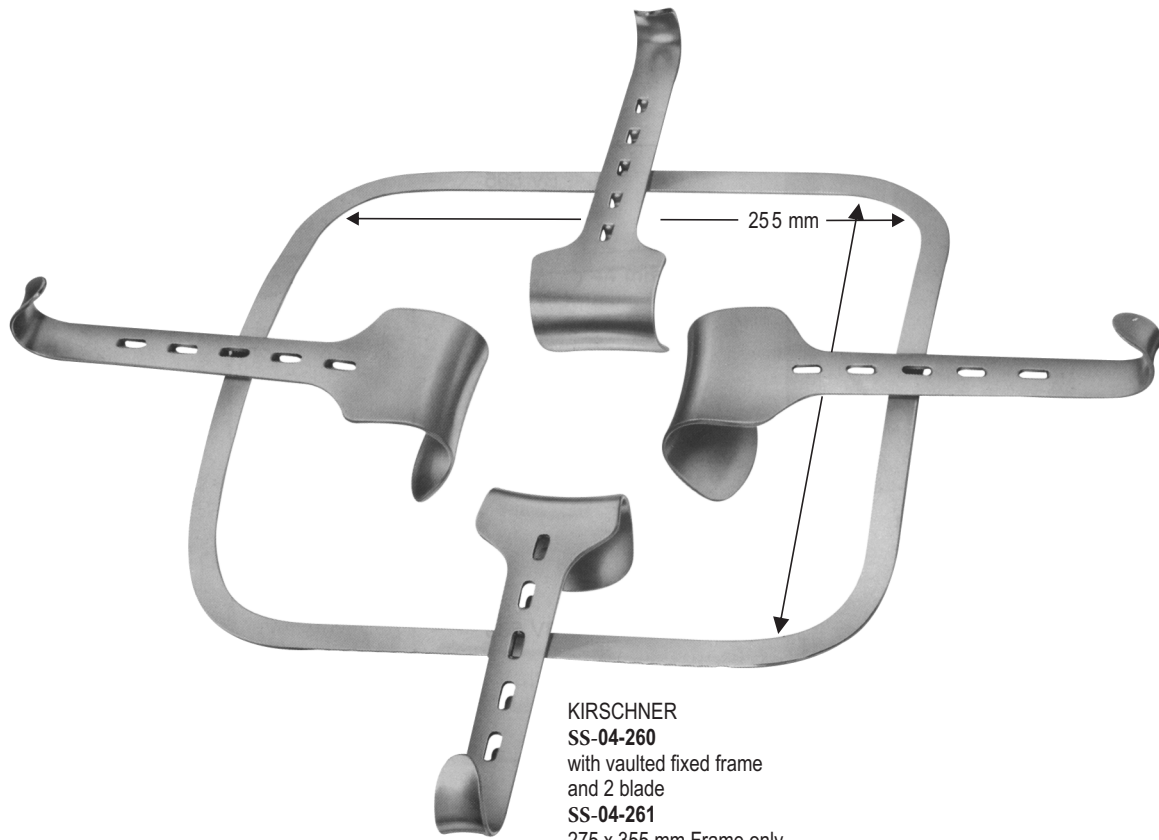

KIRSCHNER  
**SS-04-260**  
 with vaulted fixed frame  
 and 2 blade  
**SS-04-261**  
 275 x 355 mm Frame only,  
 over-sized **SS-04-262** 295  
 x 275 mm Frame only



**SS-04-263**  
 KIRSCHNER  
 64 x 80 mm



**SS-04-264**  
 KIRSCHNER-BALFOUR  
 80x 82 mm



**SS-04-265 - SS-04-267**  
 KIRSCHNER  
**SS-04-265** 90x 69mm  
**SS-04-266** 92x 95mm  
**SS-04-267** 78x 58mm



**SS-04-268 - SS-04-270**  
 KIRSCHNER  
**SS-04-268** 108x42mm  
**SS-04-269** 91x 55mm  
**SS-04-270** 121x 55mm

WE HAVE ALL RANGE OF INSTRUMENTS



## CONTACT INFO



+92-340 0473111



swisons.ind@gmail.com



www.swisons.com



Small Industrial Estate, Sialkot 51310 Pakistan

Get your high quality Instruments