

Get Your High Quality Instruments



DENTAL INSTRUMENTS

Swisons Instruments is a brand for manufacturing quality instruments. An eminent name among Disposable & Reusable Dental instruments manufacturers in Pakistan. The **Swisons Instruments** features a wide range of products details are available on website and catalogue.

www.swisons.com

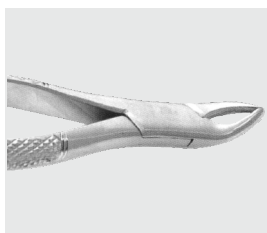

01

Extracting Forceps

Page 01-31



02

Root Elevators

Page 32-50

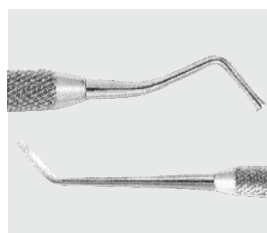

03

Filling Instruments

Page 51-55

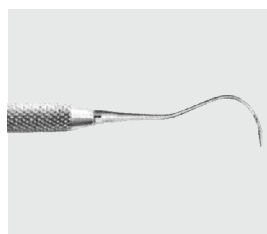

04

Dental Probes

Page 56-59

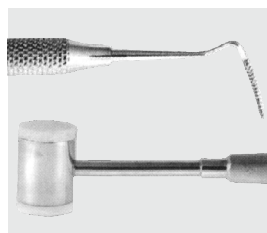

05

Periodontia Instruments
Mallets

Page 60-67

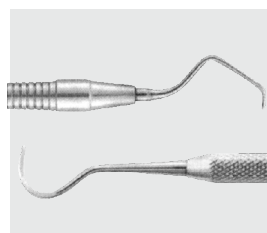

06

Curettes
Scalers

Page 68-74

TABLE OF CONTENTS

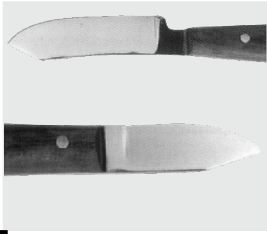
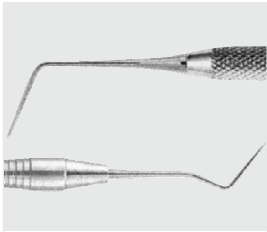
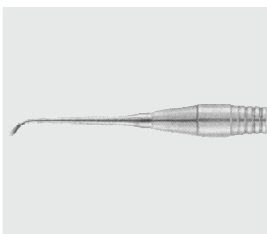
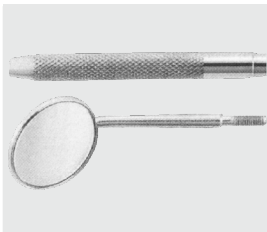
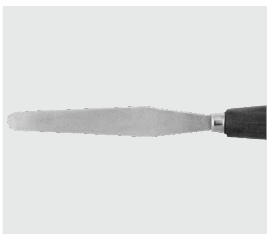
Page 75-77	Modelling Instruments Measuring Instruments	07	
Page 78-79	Wax / Plaster Knives	08	
Page 80-85	Diagnostic (Explorers) Endodontic Instruments	09	
Page 86-87	Excavators	10	
Page 88-89	Handles For Mouth Mirrors Mouth Mirrors	11	
Page 90-93	Spatulas	12	

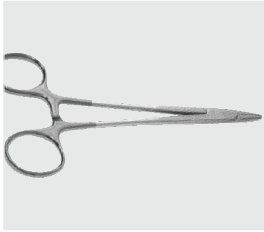

13

Needle Holders &
Saliva Ejectors

Page 94-100

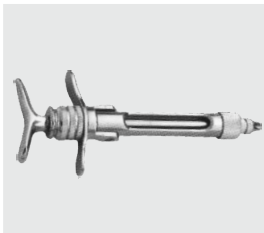

14

Syringes & Scissors

Page 101-109



15

Dental Tweezers

Page 110-114

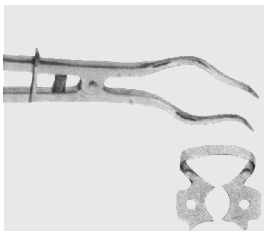

16

Rubber Dam Clamps

Page 115-117

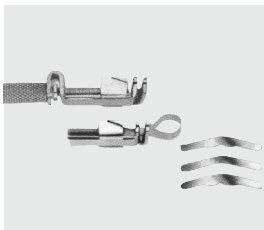

17

Matrix Retainers &
Matrix Bands

Page 118-119

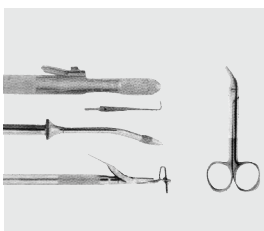





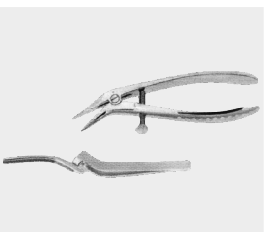
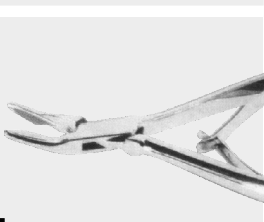

18

Crown Removers, Scissors,
Forceps, Amalgam Guns & Carriers

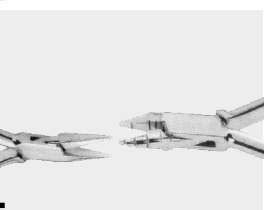
Page 120-122

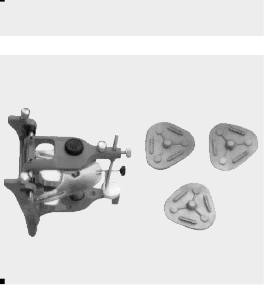
TABLE OF CONTENTS

Page 123	Copper Ring Removing Pliers & Paper Articulating Forceps	19	
Page 124-127	Rongeurs	20	
Page 128-129	Bone Elevators, Files & Chisels	21	
Page 130-151	Pliers For Orthodontics, Mouth Gags, Tongue Depressors Lip and Cheek Retractors and Implantology Instrumetns	22	
Page 152-155	Impression Trays	23	
Page 156-157	Articulators	24	
Page 158-160	Hollowares	25	



Page
1-31

- Extracting Forceps - English Pattern





SS-1-5101
Fig 8
lower premolars



SS-1-5102
Fig 13
lower premolars

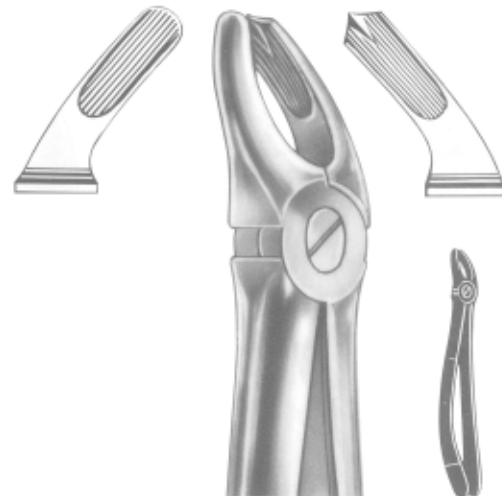

SS-1-5103
Fig 17
upper molars, right

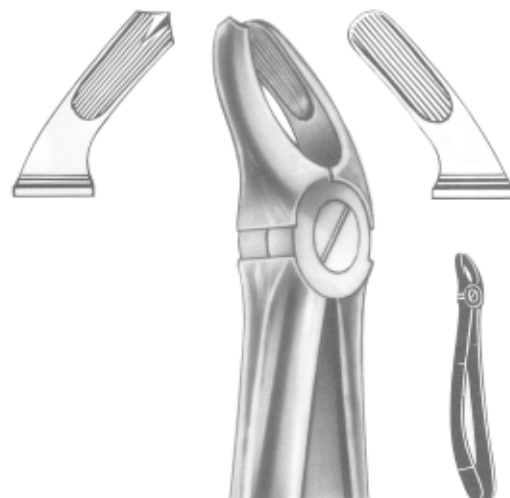

SS-1-5104
Fig 18
upper molars, left

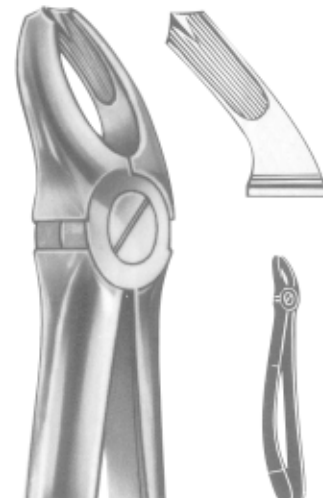

SS-1-5105
Fig 18 A
upper molars



SS-1-5106
Fig 19
upper wisdoms

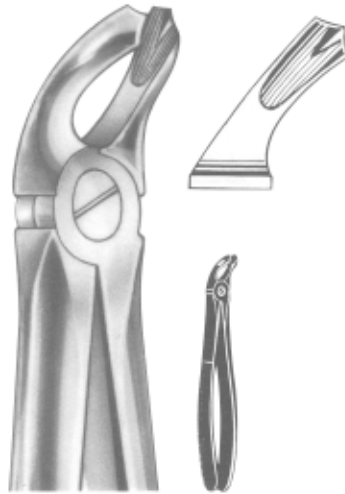

SS-1-5107
Fig 20
lower wisdoms

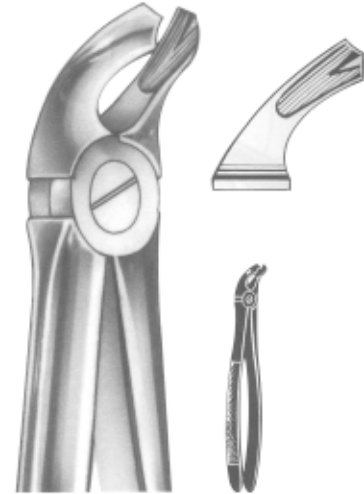

SS-1-5108
Fig 21
lower molars



SS-1-5109
Fig 22
lower molars



SS-1-5110
Fig 22 A
Albrecht
lower molars



SS-1-5111
Fig 33 A
lower roots

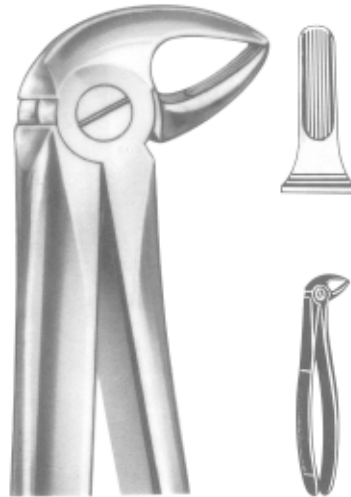

SS-1-5112
Fig 33 B
lower roots

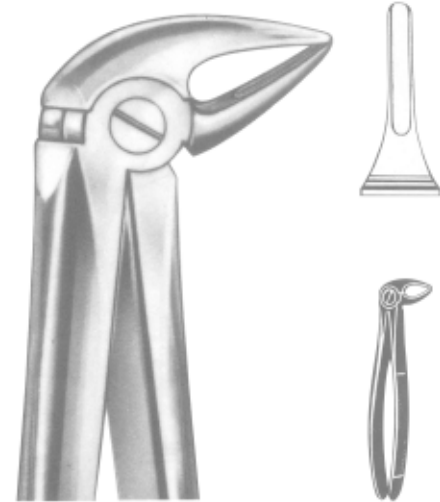

SS-1-5113
Fig 33 L
lower roots



SS-1-5114
Fig 33 L
lower roots



SS-1-5115
Fig 33 S
lower roots, for children



SS-1-5116
Fig 44
upper roots

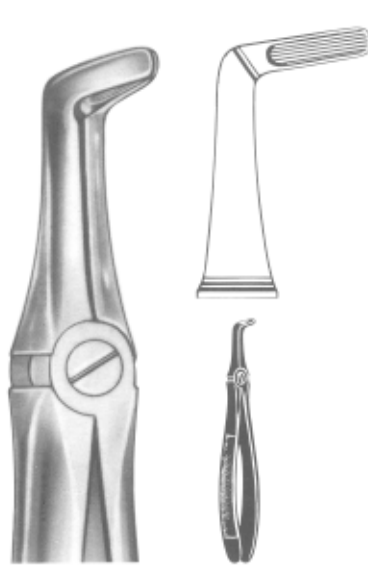

SS-1-5117
Fig 45
lower roots

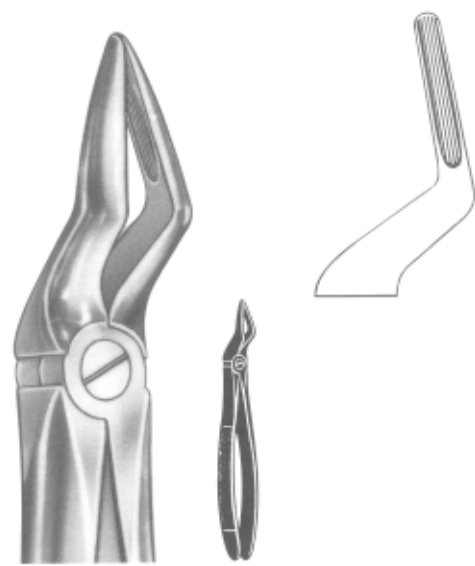

SS-1-5118
Fig 12
upper roots

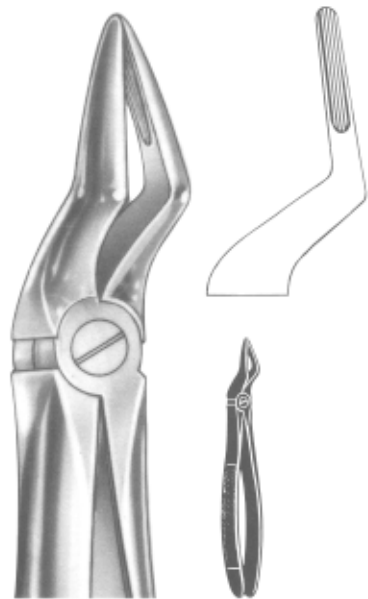

SS-1-5119
Fig 51 A
upper roots

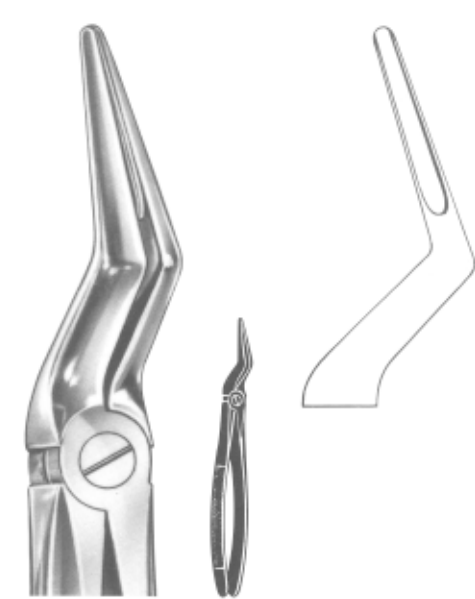

SS-1-5120
Fig 51 L
upper roots



Relax
SS-1-5121
 Fig 51
 upper roots



Relax
SS-1-5122
 Fig 51 A
 upper roots



Relax
SS-1-5123
 Fig 51 L
 upper roots



Relax
SS-1-5124
 Fig 67
 upper wisdoms



Relax
SS-1-5125
 Fig 67 A
 upper wisdoms



SS-1-5126
Fig 37
Upper incisors



WITH SERRATED
TIPS

SS-1-5127
Fig 39
Upper molars



WITH SERRATED
TIPS

SS-1-5128
Fig 39 R
Upper molars, right



WITH SERRATED
TIPS

SS-1-5129
Fig 39 L
Upper molars, left



WITH SERRATED
TIPS

SS-1-5130
Fig 515
Upper roots



Klein
SS-1-5132
Fig 137
upper incisors



Klein
SS-1-5131
Fig 6
lower molars



Klein
SS-1-5133
Fig 5
lower incisors

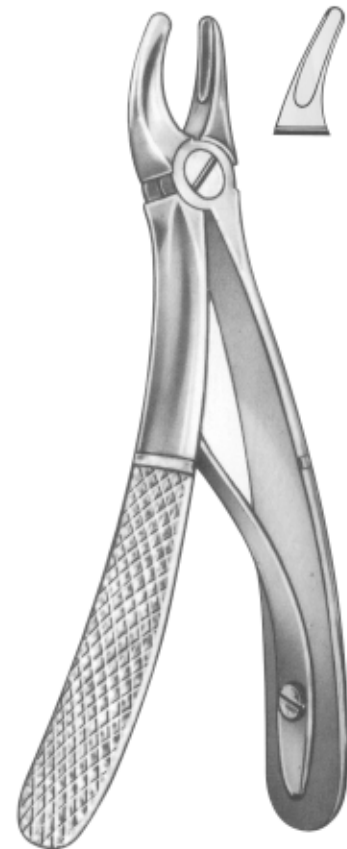

Klein
SS-1-5134
Fig 139
uper premolars



SS-1-5135
Fig 43 A
Fractured or decayed
upper teeth



WITH SERRATED
TIPS



SS-1-5136
Fig 44
Upper roots



WITH SERRATED
TIPS



SS-1-5137
Fig 45
Lower roots



WITH SERRATED
TIPS

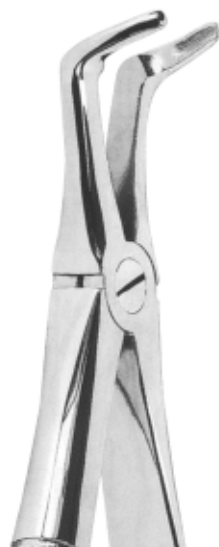

SS-1-5138
Fig 46
Lower roots



WITH SERRATED
TIPS



SS-1-5139
Fig 46 L
Lower roots



WITH SERRATED
TIPS



WITH SERRATED TIPS

SS-1-5140
Fig 48
Upper roots



WITH SERRATED TIPS

SS-1-5141
Fig 51
Upper roots



WITH SERRATED TIPS

SS-1-5142
Fig 49
Upper roots



WITH SERRATED TIPS

SS-1-5143
Fig 51 L
Upper roots



WITH SERRATED TIPS

SS-1-5144
Fig 51 A
Upper roots



SS-1-5145
Fig 51 LX
Upper roots



1046
Fig 52
Upper roots and canines



SS-1-5147
Fig 54
For separating upper molars



SS-1-5148
Fig 55
For separating upper molars



SS-1-5149
Fig 56
For separating lower molars



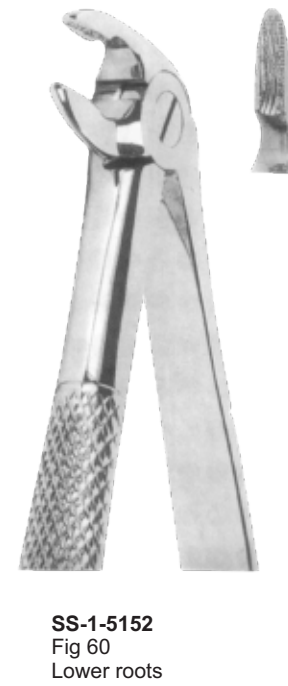



SS-1-5155
Fig 66 L
Upper molars, left



SS-1-5156
Fig 66 R
Upper molars, right



SS-1-5157
Fig 67
Upper three molars



SS-1-5158
Fig 67 A
Upper third molars



SS-1-5159
Fig 68
Lower roots





SS-1-5160
Fig 67½ L
Upper third molars, left



WITH SERRATED TIPS



SS-1-5161
Fig 67½ R
Upper third molars, right



WITH SERRATED TIPS



SS-1-5162
Fig 73
Lower molars



WITH SERRATED TIPS



SS-1-5163
Fig 74
Lower roots



WITH SERRATED TIPS



SS-1-5164
Fig 74 M
Lower roots



WITH SERRATED TIPS



SS-1-515
Fig 74 N
Lower roots



SS-1-516
6 Fig 75
Lower canines and premolars



SS-1-517
Fig 79
Lower third molars



SS-1-5168
Fig 79 A
Lower third molars



SS-1-5169
Fig 79 C
Lower third molars



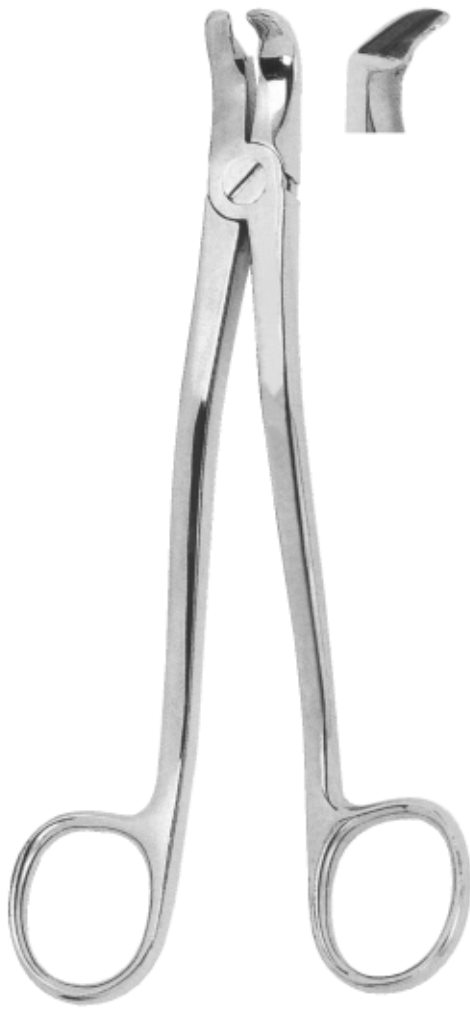

SS-1-5170
Fig 86 W
Lower third molars



SS-1-5171
Fig 86 1/2 L
Lower third molars, left



SS-1-5172
Fig 86 1/2 R
Lower third molars, right



SS-1-5173
Fig 86 C
Lower molars



SS-1-5174
Fig 87
Lower decayed molars
or broken-down crowns



WITH SERRATED
TIPS

SS-1-5175
Fig 89
Upper molars, right



WITH SERRATED
TIPS

SS-1-5176
Fig 90
Upper molars, left

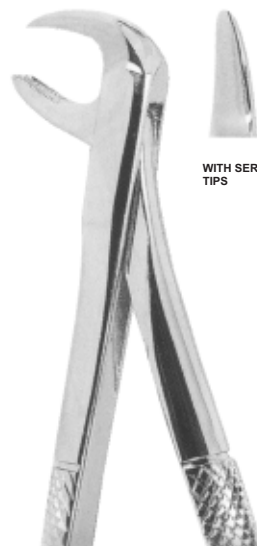

WITH SERRATED
TIPS

SS-1-5177
Fig 99
Broken-down lower molars

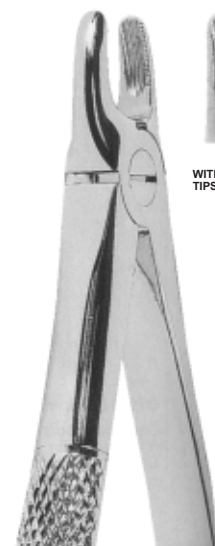

WITH SERRATED
TIPS

SS-1-5178
Fig 107
Upper canines



SS-1-5179
Fig 121
Upper third molars

WITH SERRATED TIPS



SS-1-5180
Fig 145
Lower roots

WITH SERRATED TIPS



SS-1-5181
Fig 151½
Upper roots

WITH SERRATED TIPS



SS-1-5182
Fig 166
Universal extracting forceps for upper teeth, in particular molars and premolars

WITH SERRATED TIPS



SS-1-5183
Fig 167
Universal extracting forceps for lower teeth, in particular molars and premolars

WITH SERRATED TIPS



WITH SERRATED TIPS

SS-1-5184
Fig 168
Upper canines



WITH SERRATED TIPS

SS-1-5185
Fig 169
Lower canines

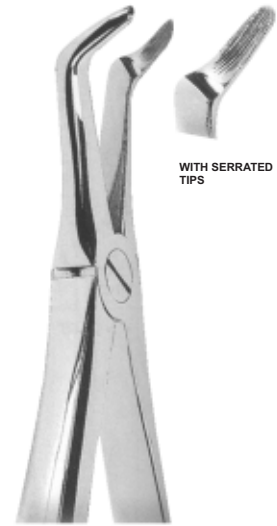

WITH SERRATED TIPS

SS-1-5186
Fig 346
Lower roots



WITH SERRATED TIPS

SS-1-5187
Fig 349
Upper roots

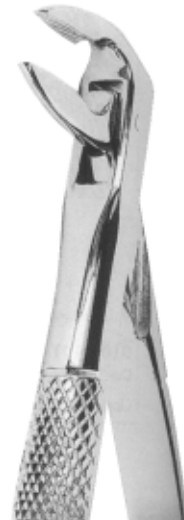

WITH SERRATED TIPS

SS-1-5188
Fig 359
Lower roots



SS-1-5189
Fig 1
Universal extracting forcep for upper incisors and canines

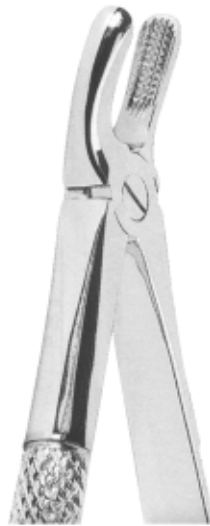

SS-1-5190
Fig 2
Upper molars

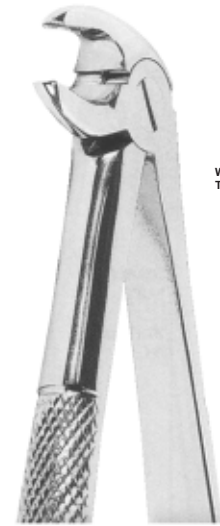

SS-1-5191
Fig 3
Lower incisors, premolar and roots



SS-1-5192
Fig 4
Lower molars





SS-1-5193
Fig 1
Upper incisors
and canines



SS-1-5194
Fig 2
Upper incisors
and canines

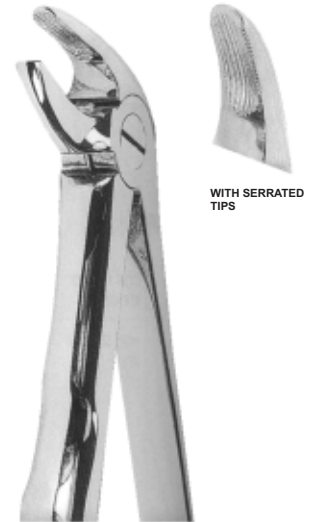

SS-1-5195
Fig 4
Lower incisors
and canines

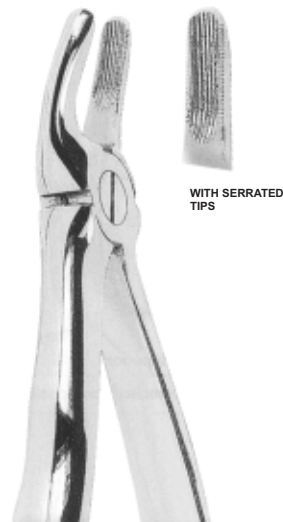

SS-1-5196
Fig 7
Upper premolars



SS-1-5197
Fig 13
Lower premolars



SS-1-5198
Fig 17
Upper molars, right



SS-1-5199
Fig 18
Upper molars, left

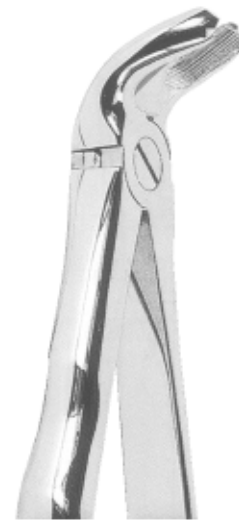

SS-1-5200
Fig 21
Lower molars



SS-1-5201
Fig 22
Lower molars



SS-1-5202
Fig 33
Lower roots





SS-1-5203
Fig 45
Lower roots



WITH SERRATED TIPS



SS-1-5204
Fig 51 A
Upper roots

WITH SERRATED TIPS



SS-1-5205
Fig 67 A
Upper third molars

WITH SERRATED TIPS



SS-1-5206
Fig 74
Lower roots

WITH SERRATED TIPS



SS-1-5207
Fig 79
Lower third molars

WITH SERRATED TIPS



SS-1-5208
Fig 86 C
Lower molars

WITH SERRATED TIPS



SS-1-5209
Fig 359
Lower roots

WITH SERRATED TIPS



SS-1-5210
Fig 89
Upper molars, right



WITH SERRATED TIPS



SS-1-5211
Fig 90
Upper molars, left



WITH SERRATED TIPS



SS-1-5212
Fig 145
Lower roots



WITH SERRATED TIPS



SS-1-5213
Fig 151 1/2
Upper roots



WITH SERRATED TIPS



SS-1-5214
Fig 349
Upper roots



WITH SERRATED TIPS



SS-1-5215
Fig 5
Lower third molars



SS-1-5216
Fig 6
Separating forceps



SS-1-5217
Fig 105
Upper molars



SS-1-5218
Fig 16
Lower molars



SS-1-5219
Fig 17
Lower molars



SS-1-5220
Fig 18 L
Upper molars, left



SS-1-5221
Fig 18 R
Upper molars, right



SS-1-5222
Fig 23
Lower molars



SS-1-5223
Fig 53 R
Upper molars, right



SS-1-5224
Fig 53 L
Upper molars, left



SS-1-5225
Fig 65
Upper incisors and roots



SS-1-5226
Fig 69
Upper and lower roots



SS-1-5227
Fig 88 R
Upper molars, right



SS-1-5228
Fig 88 L
Upper molars, left



SS-1-5229
Fig 101
Deciduous teeth



SS-1-5230
Fig 150
Upper incisors, premolars, roots



SS-1-5231
Fig 150 S
Upper teeth (for children)



SS-1-5232
Fig 151
Upper incisors, premolars, roots



SS-1-5233
Fig 151S
Lower teeth (for children)



SS-1-5234
Fig 222
Lower third molars



SS-1-5235
Fig 1
upper incisors and bicuspid

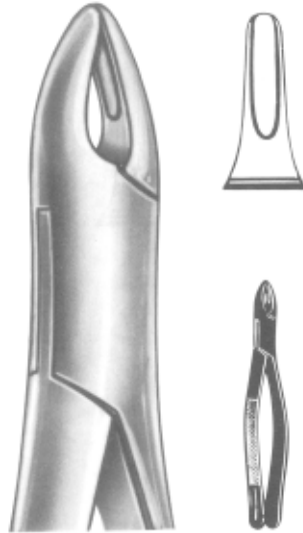

SS-1-5236
Fig 1 B
upper roots, anterior



Physick
SS-1-5237
Fig 5
lower wisdoms

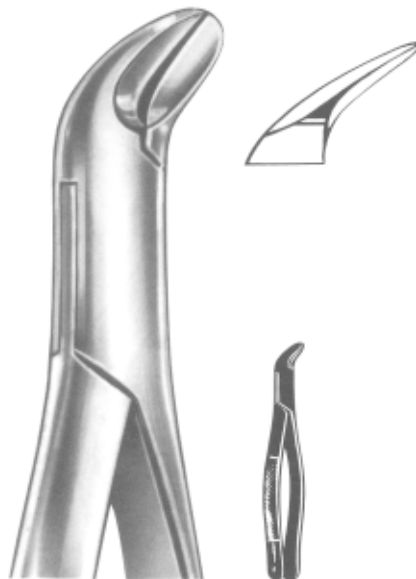

SS-1-5238
Fig 6
lower molars, splitting forceps



SS-1-5239
Fig 10 H
upper molars





SS-1-5240
Fig 135
Lower premolars



WITH SERRATED TIPS



SS-1-5241
Fig 225
Lower molars



SS-1-5242
Fig 305
Upper incisors and roots



SS-1-5243
Fig 33 S
Lower roots



WITH SERRATED TIPS



SS-1-5244
Fig 38
Lower incisors and canines



WITH SERRATED TIPS



SS-1-5245
Fig 1
Upper incisors



WITH SERRATED TIPS



SS-1-5246
Fig 2
Upper permolars



WITH SERRATED TIPS



SS-1-5247
Fig 3
Upper molars



WITH SERRATED TIPS



SS-1-5248
Fig 4
Upper roots



WITH SERRATED TIPS



SS-1-5249
Fig 5
Lower incisors



WITH SERRATED TIPS



SS-1-5250
Fig 6
Lower molars



WITH SERRATED TIPS



SS-1-5251
Fig 7
Lower roots



WITH SERRATED TIPS



SS-1-5252
Fig 1
Lower roots



SS-1-5253
Fig 2
Upper roots



SS-1-5255
Fig 2
Roots fragments



SS-1-5254
Fig 1
Roots fragments



Page
32-50

- Root Elevators



lower jaw, left side

lower jaw, right side

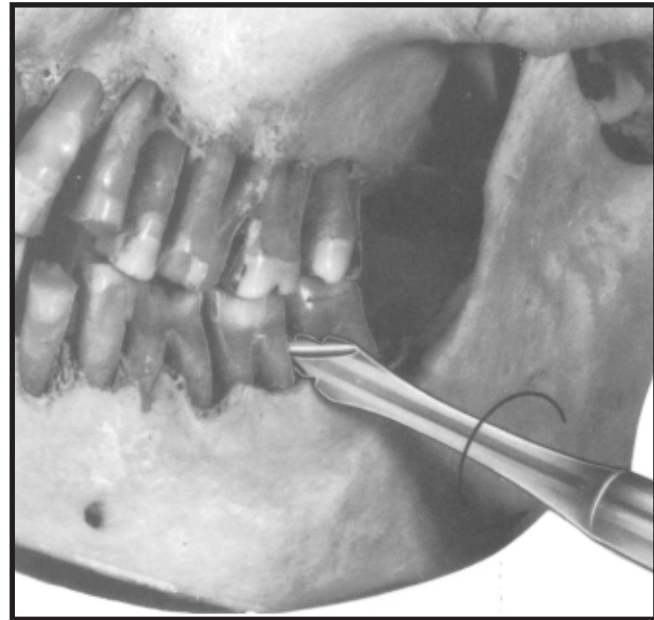

SS-2-5101



SS-2-5102

Root elevator, spiral-shaped, for extremely facilitated extraction of the molars in the lower jaw. The slender, conical points allow deep penetration between tooth and gum. Owing to the hook-shaped working parts, slipping of the elevator is avoided.



Bein

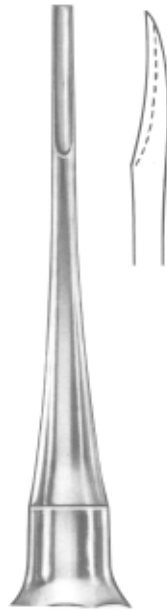

Bein
SS-2-5103
Fig 1



Bein
SS-2-5104
Fig 2

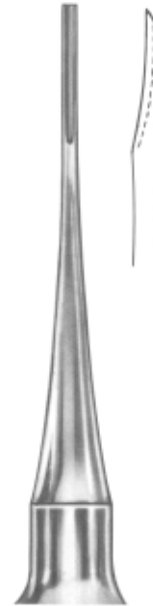

Bein
SS-2-5105
Fig 0



Bein
SS-2-5106
Fig 3

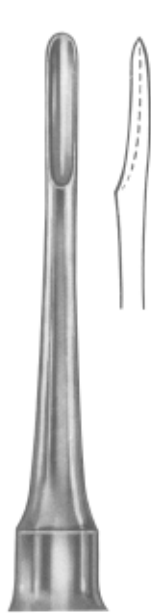

Bein
SS-2-5107
Fig 4



Bein
SS-2-5108
Fig 5

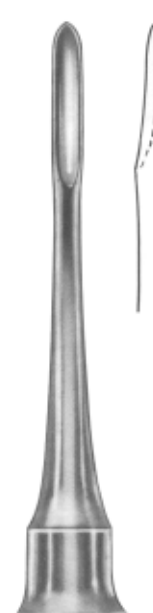

Bein
SS-2-5109
Fig 6



Seldin



Seldin
SS-2-5110
Fig 1L



Seldin
SS-2-5111
Fig 1R



Seldin
SS-2-5112
Fig 2



Seldin
SS-2-5113
Fig 3



Seldin
SS-2-5114
Fig 4L



Seldin
SS-2-5115
Fig 4R



**Cryer
SS-2-5116
Fig 3**



**Cryer
SS-2-5117
Fig 4**



**Cryer
SS-2-5118
Fig 12**



**Cryer
SS-2-5119
Fig 27**



**Cryer
SS-2-5120
Fig 28**



**Cryer
SS-2-5121
Fig 27 S**



**Cryer
SS-2-5122
Fig 28 S**



Apical



Apical
SS-2-5123
Fig 1



Apical
SS-2-5124
Fig 2



Apical
SS-2-5125
Fig 3



Apical
SS-2-5126
Fig 4



Cryer



Cryer
SS-2-5127
Fig 1

Cryer
SS-2-5128
Fig 2



Coupland



Coupland
SS-2-5129
Fig 1

Coupland
SS-2-5130
Fig 2

Coupland
SS-2-5131
Fig 3



SS-2-5132
Fig 1

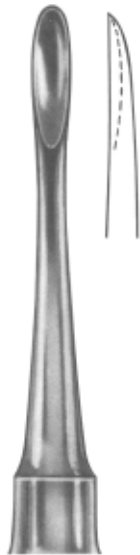

SS-2-5133
Fig 2

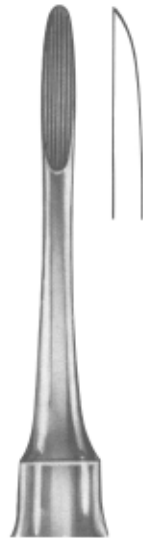

SS-2-5134
Fig 3



Flohr
SS-2-5135
Fig 1



Flohr
SS-2-5136
Fig 2



Flohr
SS-2-5137
Fig 3



Kopp
SS-2-5138
Fig 1



Kopp
SS-2-5139
Fig 2



Kopp
SS-2-5144
Fig 1



Kopp
SS-2-5145
Fig 2



Kopp



Kopp
SS-2-5140
Fig 3



Kopp
SS-2-5141
Fig 4



Kopp



Kopp
SS-2-5146
Fig 3



Kopp
SS-2-5147
Fig 4



Kopp
SS-2-5142
Fig 5



Kopp
SS-2-5143
Fig 6



Hylin



Hylin
SS-2-5148
Fig 1



Hylin
SS-2-5149
Fig 2



Bein

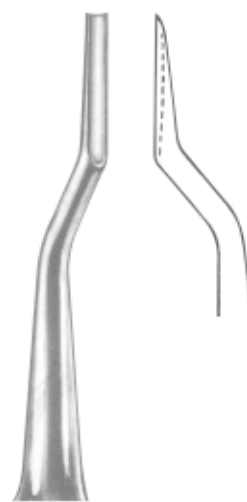

Bein
SS-2-5150
Fig 1



Bein
SS-2-5152
Fig 3

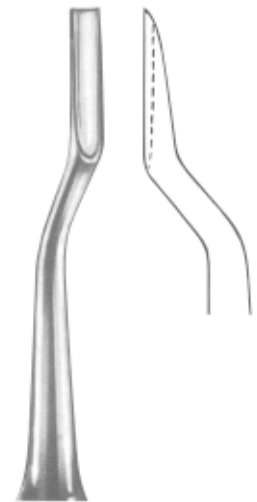

Bein
SS-2-5151
Fig 2



Bein
SS-2-5153
Fig 4



**Warwick-James
SS-2-5154
Fig 1**



**Warwick-James
SS-2-5155
Fig 2**



**Warwick-James
SS-2-5156
Fig 3**

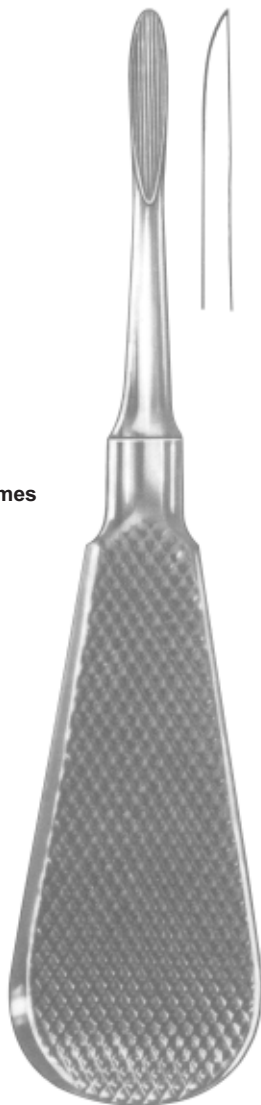

**London
Hospital
SS-2-5157
Fig 1**



**London
Hospital
SS-2-5158
Fig 2**



**London
Hospital
SS-2-5159
Fig 3**



**Ott
SS-2-5160**

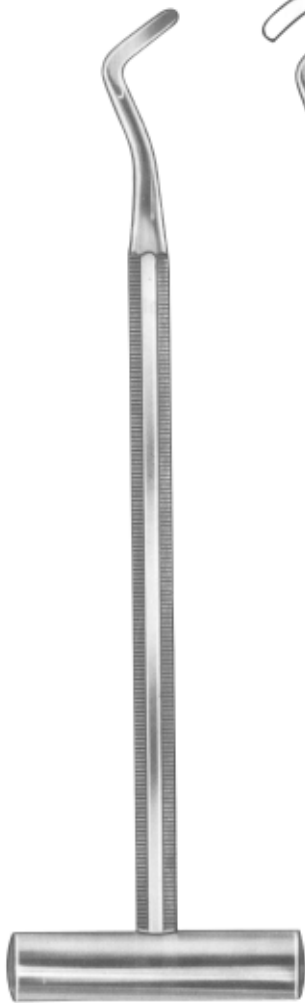

Pott



Pott
SS-2-5162
Fig 1



Pott
SS-2-5163
Fig 2

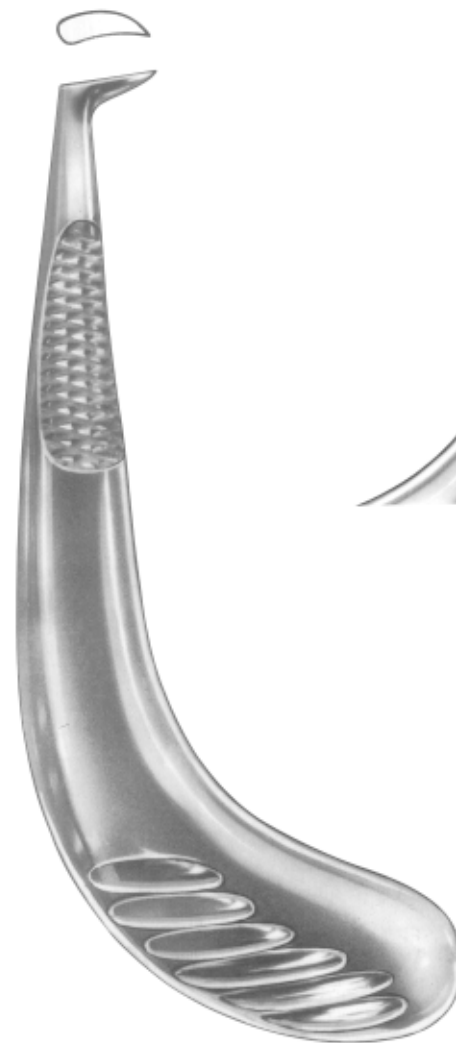

SS-2-5164
Fig 1

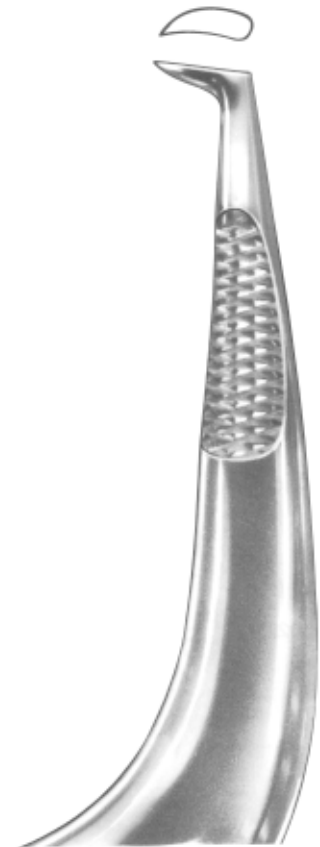

SS-2-5165
Fig 2



**Mead
SS-2-5166
MD 1**



**Mead
SS-2-5167
MD-5 A**



**Mead
SS-2-5168
MD-6 A**



**Mead
SS-2-5169
MD-7 A**



**Mead
SS-2-5170
MD-8**

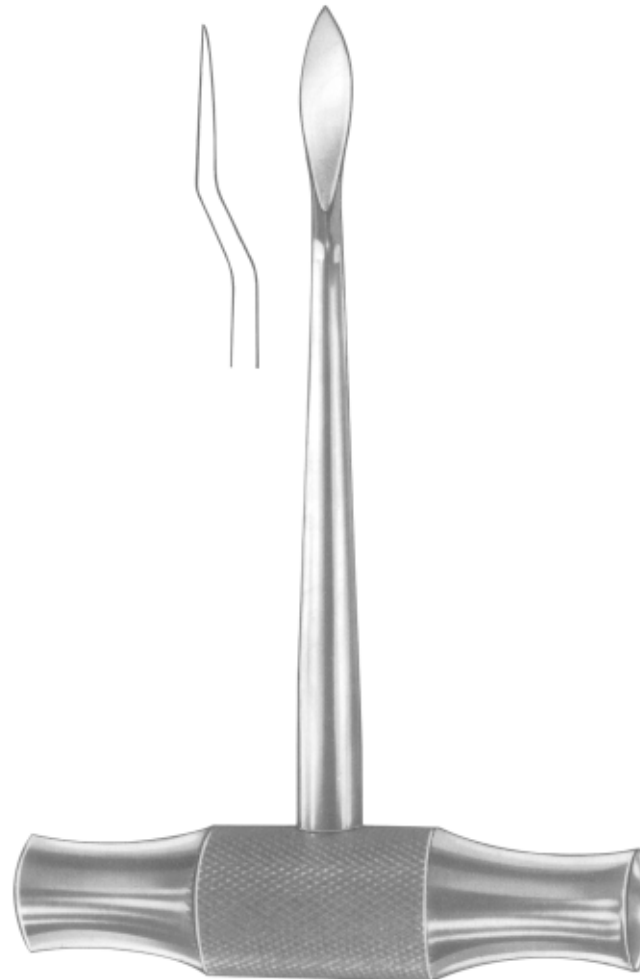

**Lecluse
SS-2-5171**



**Chompret
SS-2-5172
Fig 1**



**Chompret
SS-2-5173
Fig 2**



**Chompret
SS-2-5174
Fig 3**



**Chompret
SS-2-5175
Fig 4**



**Apical
SS-2-5176**



SS-2-5177
Fig 1



SS-2-5178
Fig 2



SS-2-5179
Fig 3



Heidbrink
SS-2-5180
Fig 1



Heidbrink
SS-2-5181
Fig 2



Heidbrink
SS-2-5182
Fig 3



Winter
SS-2-5183
Fig 1L



Winter
SS-2-5184
Fig 1R



Winter
SS-2-5185
Fig 2L



Winter
SS-2-5186
Fig 2R



Winter



Winter
SS-2-5187
Fig 11 L



Winter
SS-2-5188
Fig 11 R



Winter
SS-2-5189
Fig 12 L



Winter
SS-2-5190
Fig 12 R



Winter
SS-2-5191
Fig 14 L



Winter
SS-2-5192
Fig 14 R



Barry
SS-2-5193
Fig 1



Barry
SS-2-5194
Fig 2



Barry
SS-2-5195
Fig 3



Barry
SS-2-5196
Fig 4



Barry



Barry
SS-2-5197
Fig 11



Barry
SS-2-5198
Fig 12



Barry
SS-2-5199
Fig 17



Barry
SS-2-5200
Fig 18



Cryer
SS-2-5201
Fig 26



Seldin
SS-2-5202
Fig 27



Cryer
SS-2-5203
Fig 28



Cryer
SS-2-5204
Fig 29



Heidbrink
SS-2-5205
Fig 22



Heidbrink
SS-2-5206
Fig 23



SS-2-5207



Kopp
SS-2-5208
Fig 31



Kopp
SS-2-5209
Fig 32



Kopp
SS-2-5210
Fig 33



Kopp
SS-2-5211
Fig 34



Kopp
SS-2-5212
Fig 35



Kopp
SS-2-5213
Fig 44



SS-2-5214



Heidbrink
SS-2-5215
Fig 10



Winter
SS-2-5216
Fig 11



Winter
SS-2-5217
Fig 12



Barry
SS-2-5218
Fig 17



Barry
SS-2-5219
Fig 18



SS-2-5220
Fig 20



SS-2-5221

Root Elevators according to Dr. Sader,
with interchangeable working tips



SS-2-5222

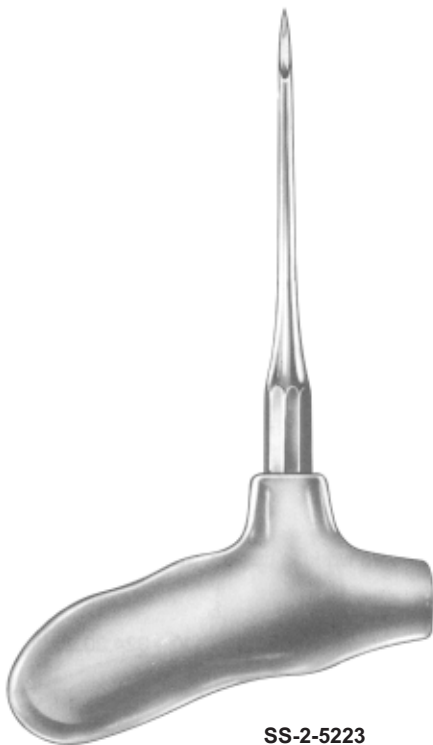

SS-2-5223



SS-2-5224



Page
51-55

- Filling Instruments





SS-2-5225
Williams

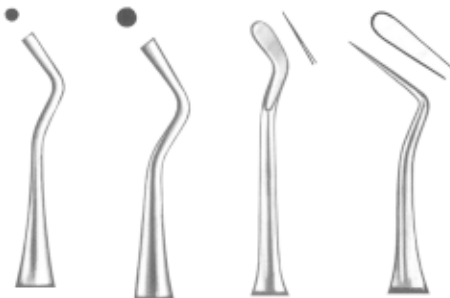

SS-2-5226 Williams
SS-2-5227 Williams
SS-2-5228 Williams
SS-2-5229 Williams

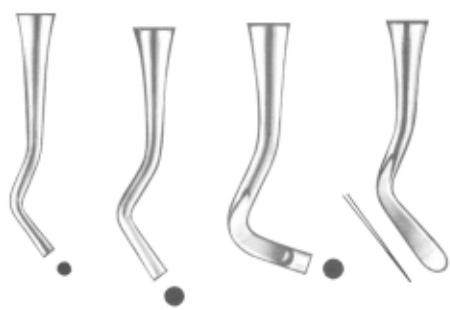

SS-2-5233
White



SS-2-5234 White
SS-2-5235 White
SS-2-5236 White

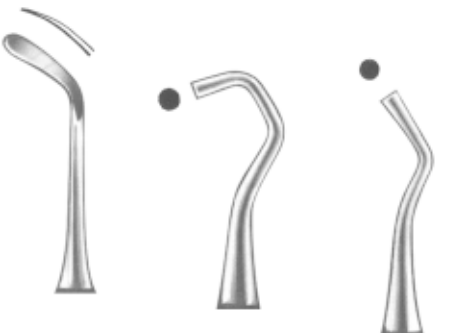

SS-2-5230 Williams
SS-2-5231 Williams
SS-2-5232 Williams



SS-2-5237 White
SS-2-5238 White
SS-2-5239 White



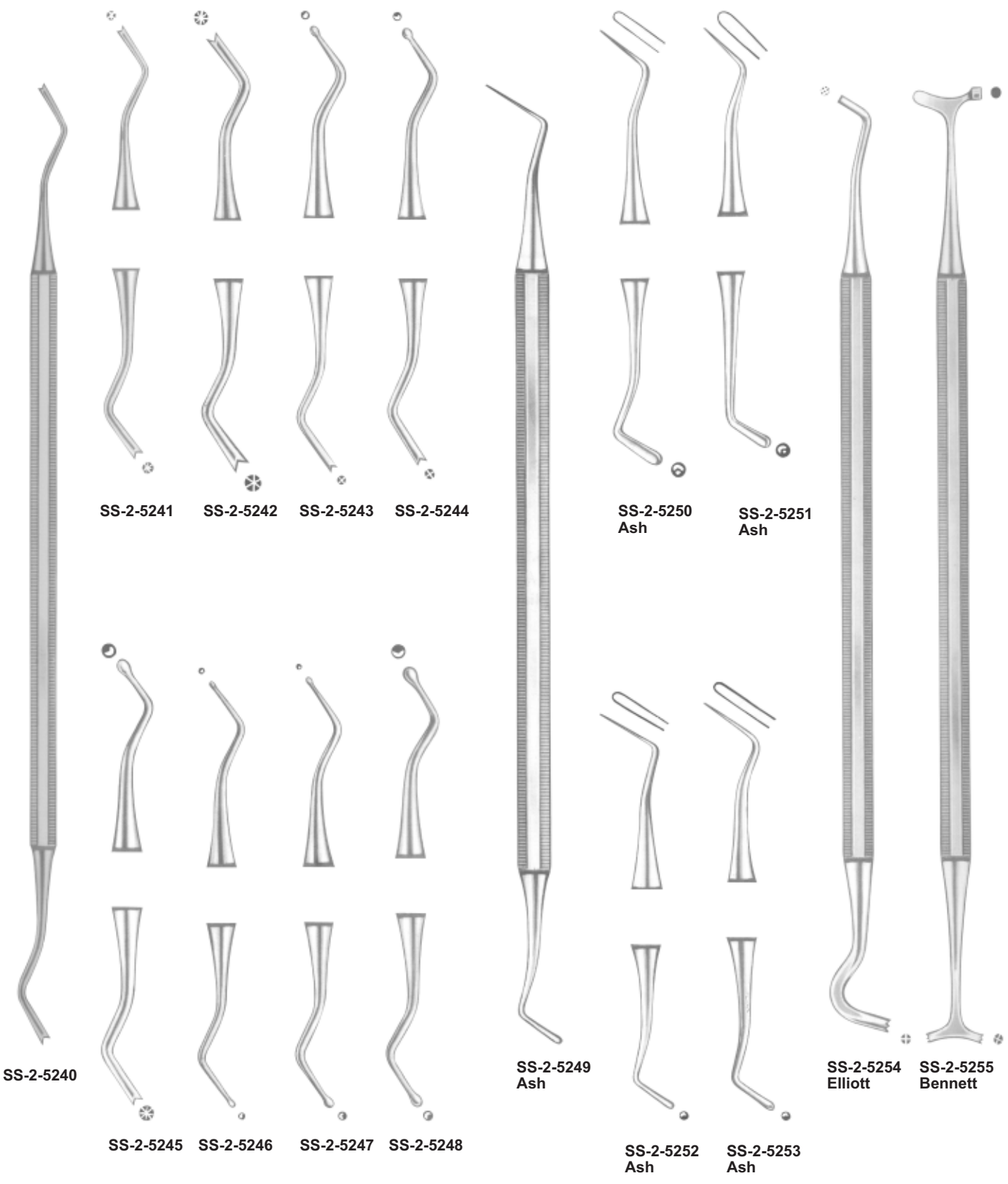

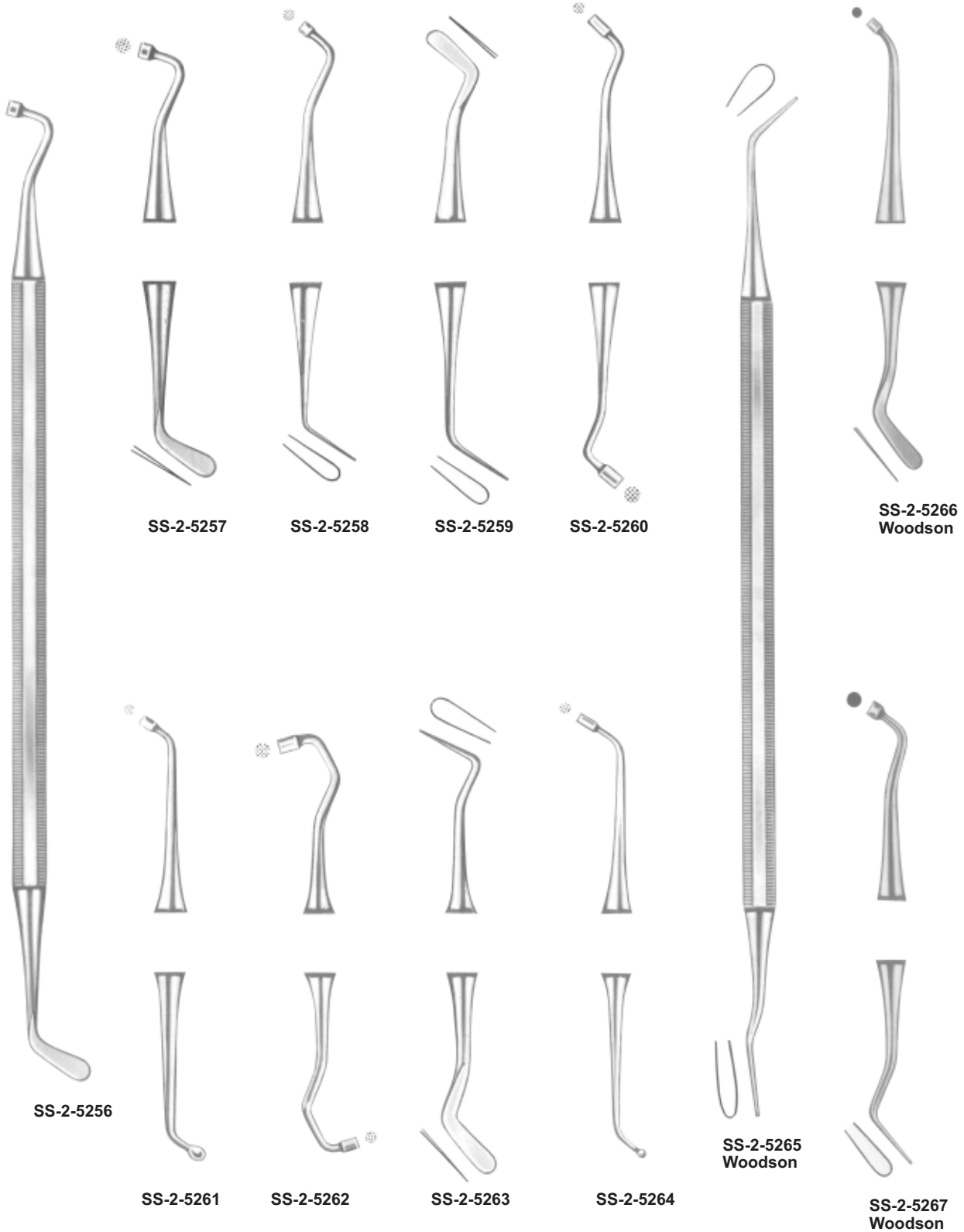

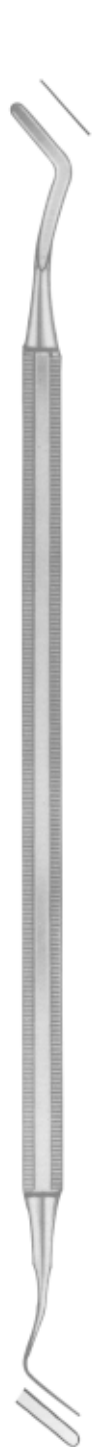

SS-2-5268
Heidemann
Fig 1



SS-2-5269
Heidemann
Fig 2



SS-2-5270
Heidemann
Fig 3

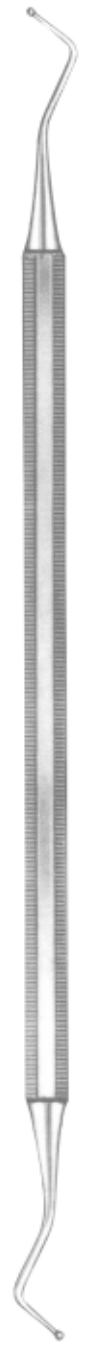

SS-2-5271



SS-2-5272
Fig 146



SS-2-5274
Fig 148



SS-2-5273
Fig 147



SS-2-5275
Fig 149

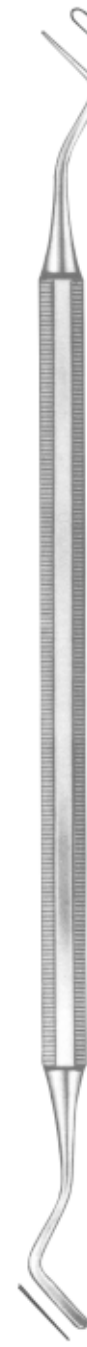

SS-2-5276
Fig 158



SS-2-5277
Fig 159



SS-2-5278
Woodson
Fig 160



SS-2-5279
Gracey



SS-2-5280
Gracey
Fig 1



SS-2-5281
Gracey
Fig 2



SS-2-5282
Gracey
Fig 3



SS-2-5283
Gracey
Fig 4



SS-2-5284
Gracey
Fig 5



SS-2-5285
Gracey
Fig 6



SS-2-5286



SS-2-5287
Fig 18



SS-2-5288
Fig 19



SS-2-5289
Fig 20



SS-2-5290
Fig 22



SS-2-5291
Fig 23



SS-2-5292
Fig 25



SS-2-5293
Fig 26



SS-2-5294
Fig 27





Page
56-59

- Dental Probes



With Point Set In



SS-2-5295



SS-2-5296



SS-2-5297



SS-2-5298



SS-2-5299



SS-2-5300



SS-2-5301



SS-2-5302



SS-2-5303



SS-2-5304



SS-2-5305



SS-2-5306



SS-2-5307
Woodson

Polishing Instruments

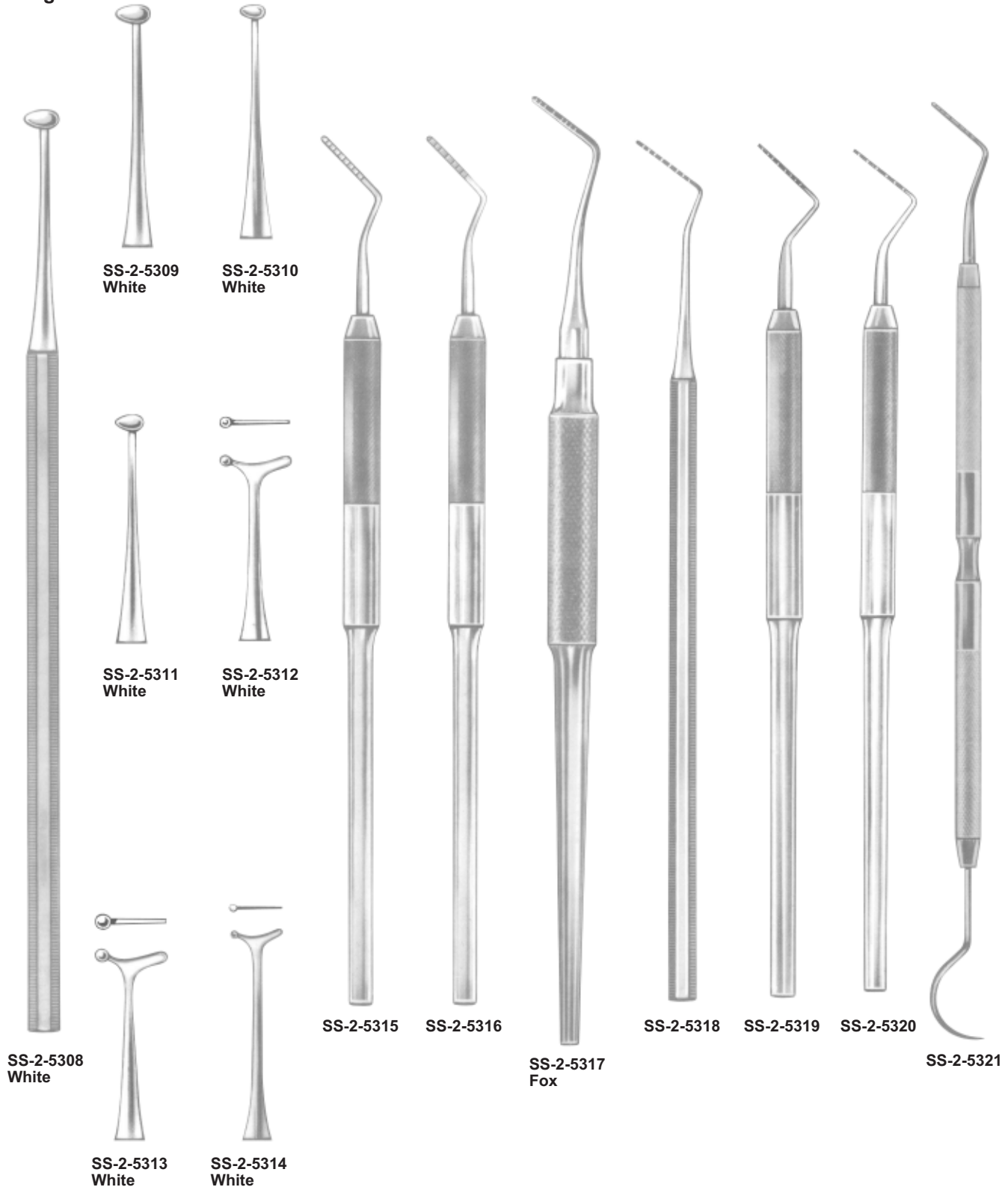

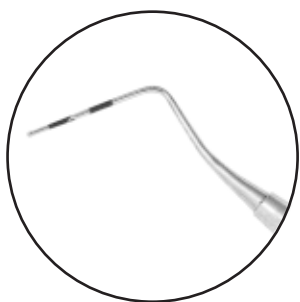

- New marking process.
- Laser system marking.
- No more paint peeling off.
- Permanent marking.
- Antiglare, low depth marking.
- Maximum tip resistance against breaking.



SS-2-5322
Fig CP-C



SS-2-5323
Fig CP-11



SS-2-5324
Fig CP-12



SS-2-5325
Fig CP-12S
O.M.S

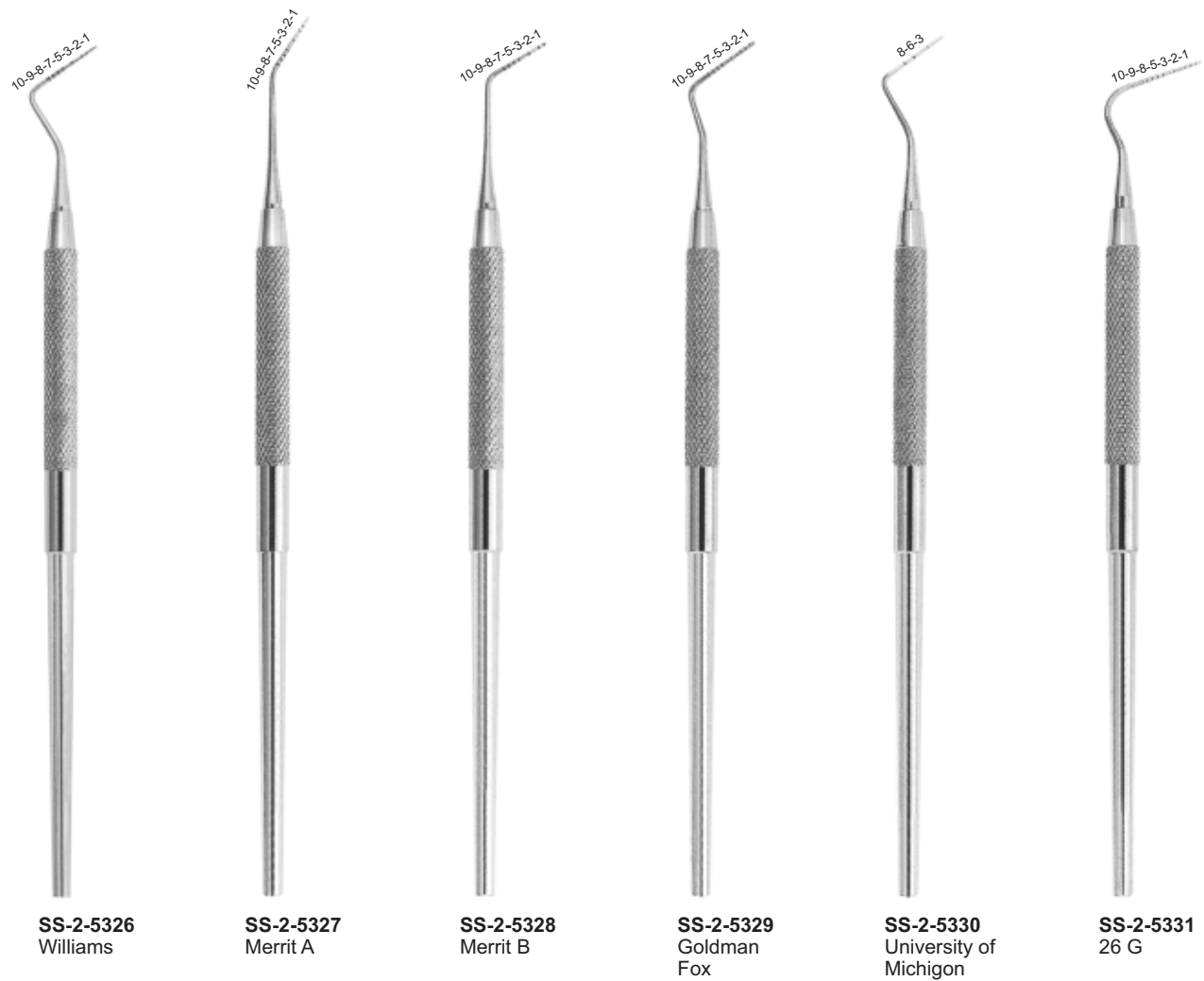



Page
60–67

- Periodontia Instruments, Mallets



Files

Chisels



SS-3-5101
Sugarman
Fig. 1S/2S



SS-3-5102
Sugarman
Fig. 3S/4S



SS-3-5103
Schluger
Fig. 9/10



SS-3-5104
Buck
Fig. 11/12



SS-3-5105
Ochsenbein
Fig. 3



SS-3-5106
Ochsenbein
Fig. 4



SS-3-5107
Rhodes
Back - Action
Fig. 36/37

Files

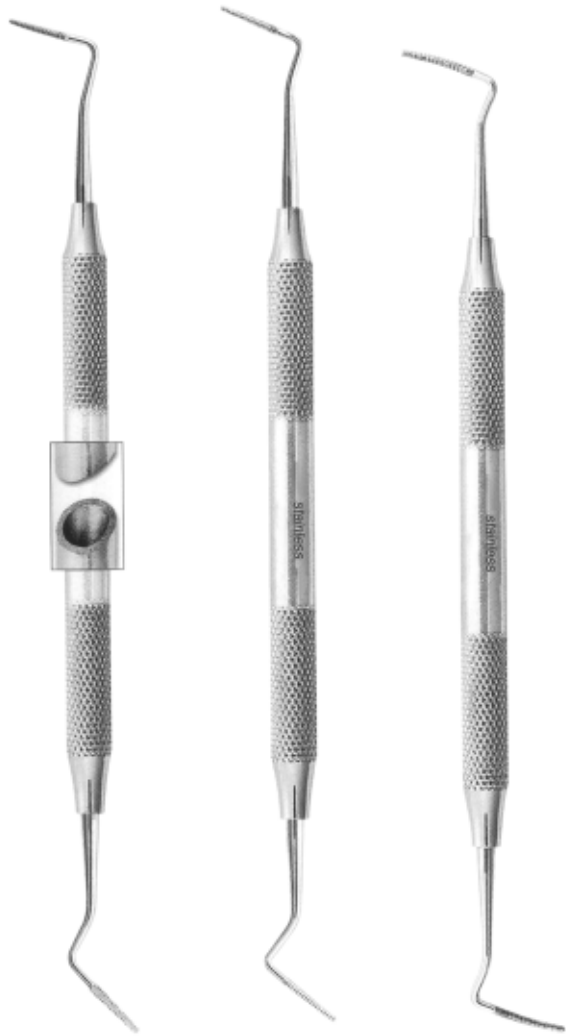

SS-3-5108
Sugarman
Fig. 1S/2S

SS-3-5109
Sugarman
Fig. 3S/4S

SS-3-5110
Schluger
Fig. 9/10



SS-3-5111
Buck
Fig. 11/12

Chisels



SS-3-5112
Ochsenbein
Fig. 3



SS-3-5113
Ochsenbein
Fig. 4



SS-3-5114
Rhodes
Back - Action
Fig. 36/37

Gingivectomy knives



SS-3-5115
Goldman-Fox
Fig. 7



SS-3-5116
Goldman-Fox
Fig. 8



SS-3-5117
Goldman-Fox
Fig. 9



SS-3-5118
Goldman-Fox
Fig. 11



SS-3-5119
Buck
Fig. 3/4



SS-3-5120
Buck
Fig. 5/6

Curettes and Scalers



SS-3-5121
Curette
Fig. HU 1/2



SS-3-5122
Columbia
Fig. 2R/2L



SS-3-5123
Columbia
Fig. 4R/4L



SS-3-5124
Columbia
Fig. 13/14



SS-3-5125
Fig. 411/412



SS-3-5126
Fig. 413/414



SS-3-5127
Zerfing-chisel

Gingivectomy knives

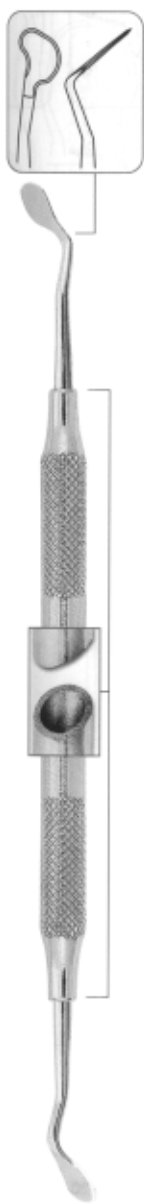

SS-3-5128
Goldman - Fox
Fig. 7



SS-3-5129
Goldman - Fox
Fig. 8



SS-3-5130
Goldman - Fox
Fig. 9



SS-3-5131
Goldman - Fox
Fig. 11



SS-3-5132
Buck
Fig. 3/4



SS-3-5133
Buck
Fig. 5/6

Curettes and Scalers



SS-3-5134
Curette
Fig. HU 1/2



SS-3-5135
Columbia
Fig. 2R/2L



SS-3-5136
Columbia
Fig. 4R/4L



SS-3-5137
Columbia
Fig. 13/14



SS-3-5138
Fig. 413/412



SS-3-5139
Fig. 411/414



SS-3-5140
Zerfing-chisel

Bone Chisels and Gouges

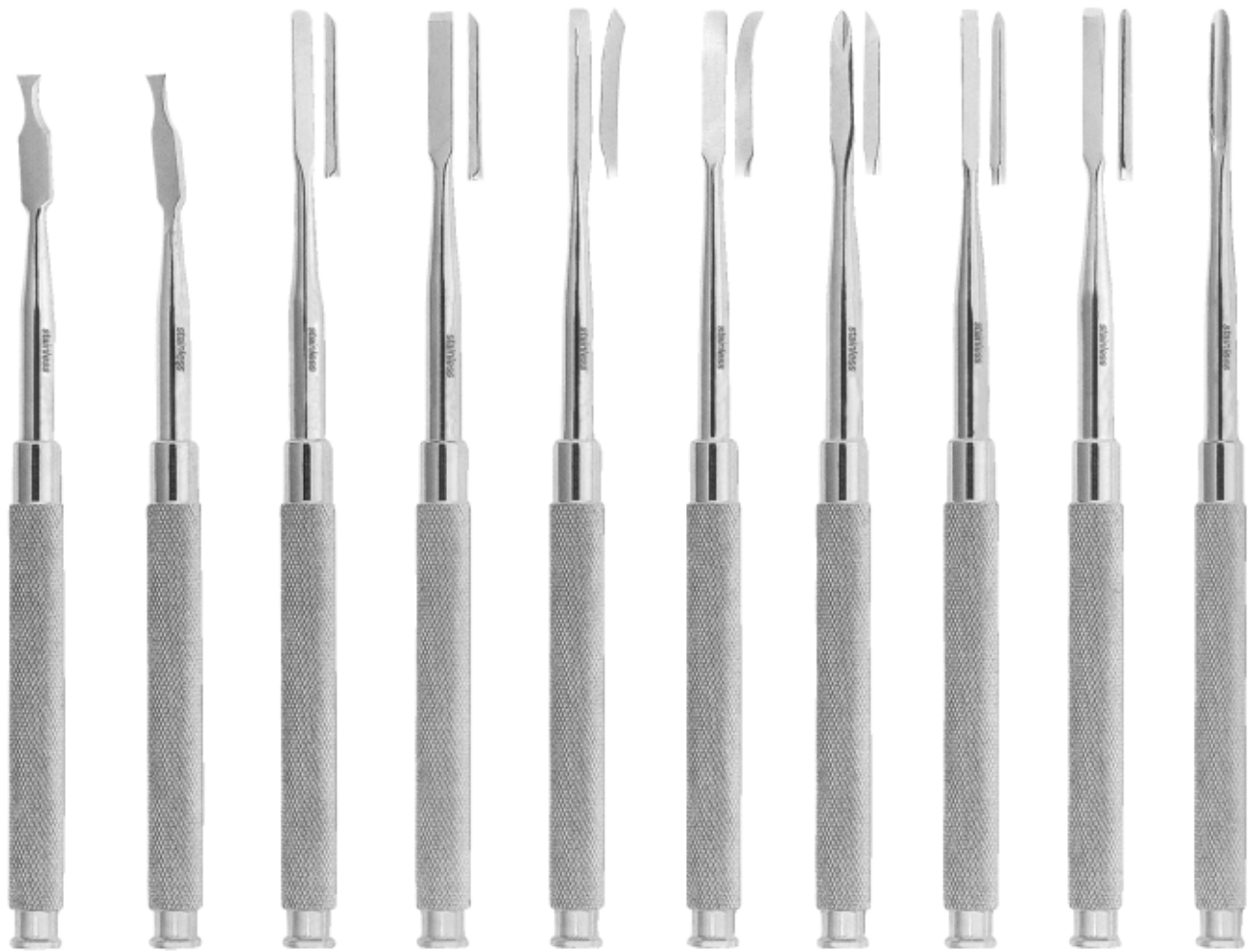

SS-3-5141
Ochsenbein
Fig. 1

SS-3-5142
Ochsenbein
Fig. 2

SS-3-5143
Gardner
Fig. 1

SS-3-5144
Gardner
Fig. 2

SS-3-5145
Gardner
Fig. 5

SS-3-5146
Gardner
Fig. 5R

SS-3-5147
Gardner
Fig. 6

SS-3-5148
Wakefield
Fig. 1W

SS-3-5149
Wakefield
Fig. 2W

SS-3-5150
Buckley
Fig. 3

Bone Chisels and Gouges

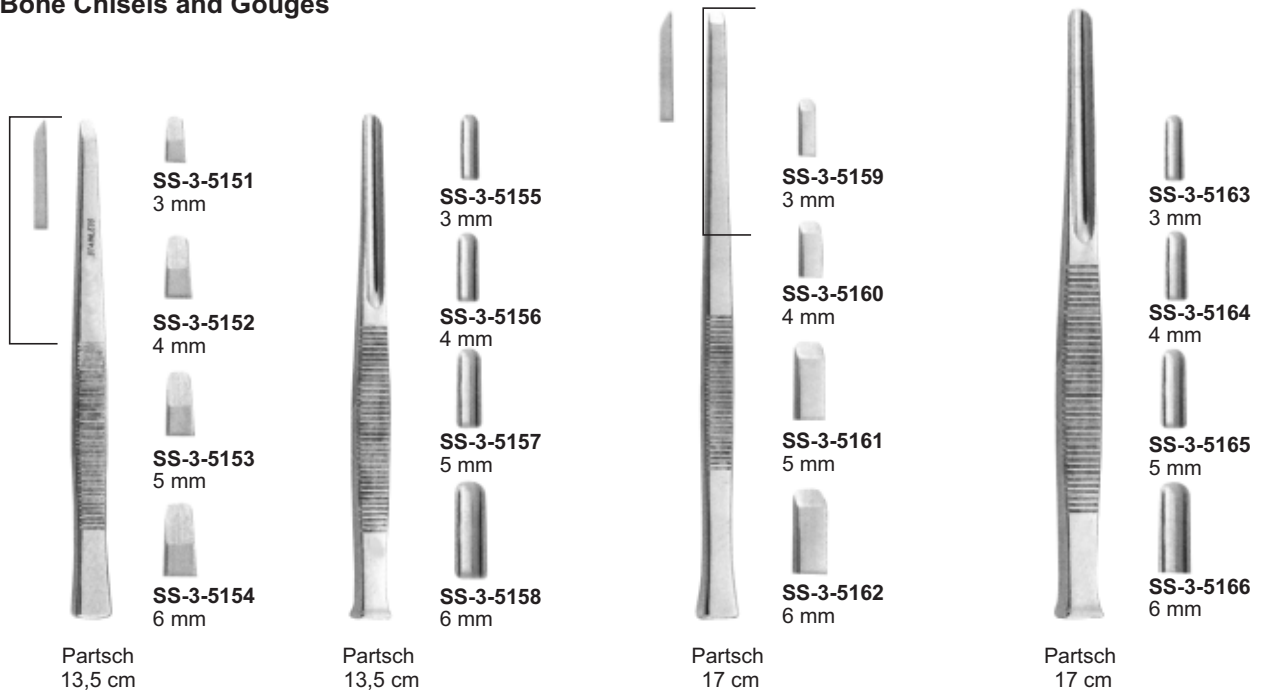

Martelli chirurgici
Mallet

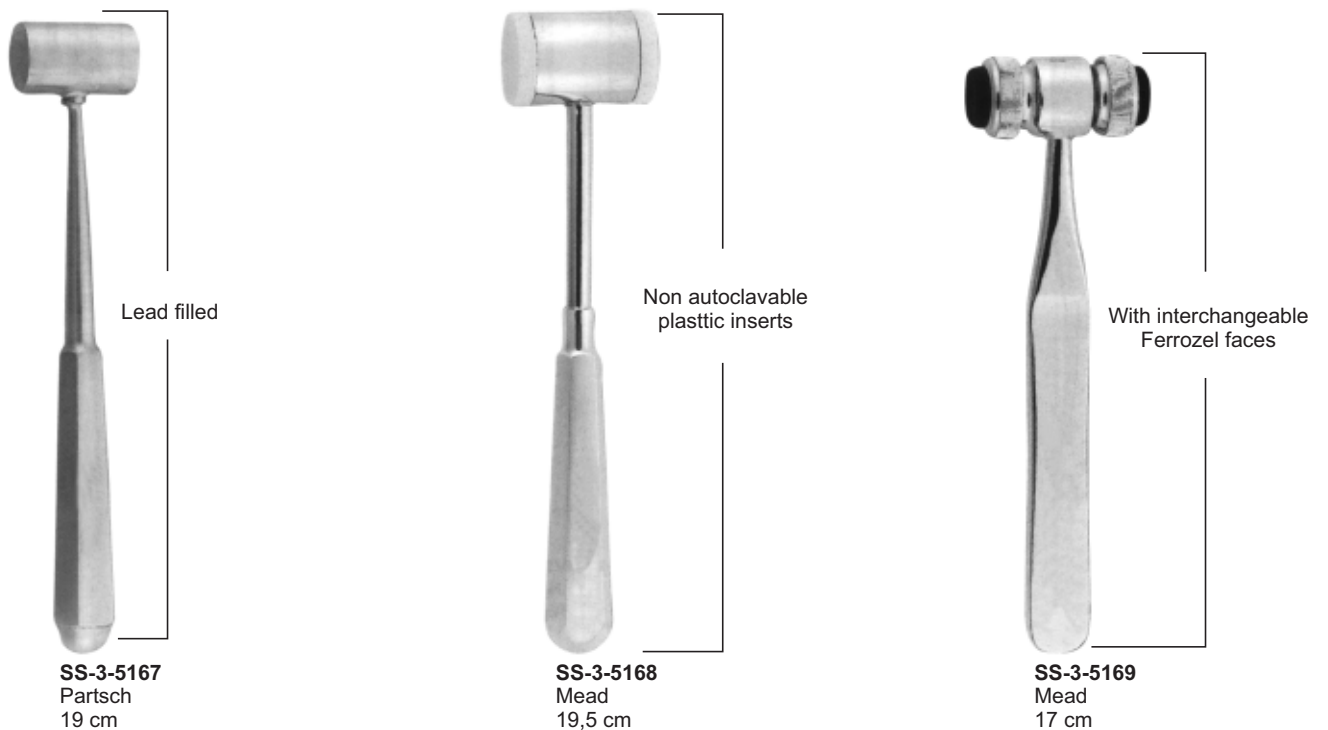



Page
68-74

- Currettes Scalers



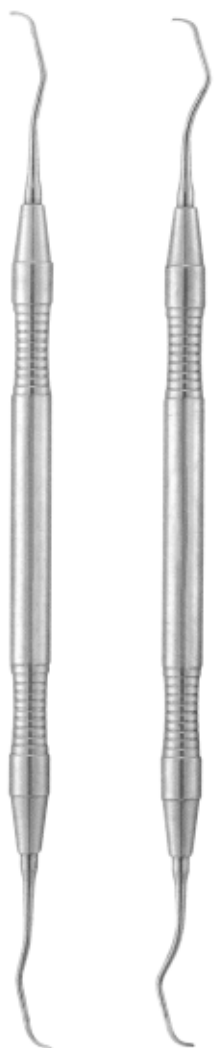
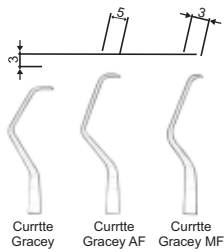

SS-3-5170
Gracey
Fig. 1/2



SS-3-5171
Gracey
Fig. 3/4



SS-3-5172
Gracey
Fig. 5/6



SS-3-5173
Gracey
Fig. 7/8



SS-3-5174
Gracey
Fig. 9/10



SS-3-5175
Gracey
Fig. 11/12



SS-3-5176
Gracey
Fig. 13/14



SS-3-5177
Gracey
Mesial Distal
Fig. 11/14



SS-3-5178
Gracey
Mesial Distal
Fig. 12/13

Gracey Curettes AF Type

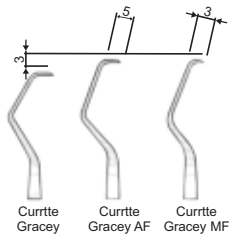

SS-3-5179
Gracey
AF/type
Fig. 1/2



SS-3-5180
Gracey
AF/type
Fig. 3/4



SS-3-5181
Gracey
AF/type
Fig. 5/6



SS-3-5182
Gracey
AF/type
Fig. 7/8



SS-3-5183
Gracey
AF/type
Fig. 11/12



SS-3-5184
Gracey
AF/type
Fig. 13/14



SS-3-5185
Gracey
AF/type
Fig. 15/16

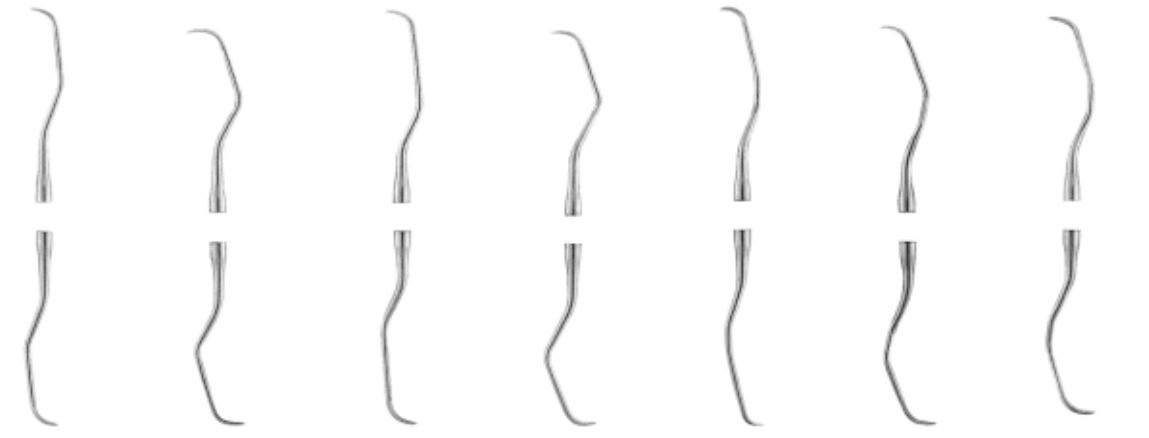

SS-3-5187
Gracey
AF/type
Fig. 1/2

SS-3-5188
Gracey
AF/type
Fig. 3/4

SS-3-5189
Gracey
AF/type
Fig. 5/6

SS-3-5190
Gracey
AF/type
Fig. 7/8

SS-3-5191
Gracey
AF/type
Fig. 11/12

SS-3-5192
Gracey
AF/type
Fig. 13/14

SS-3-5193
Gracey
AF/type
Fig. 15/16



SS-3-5186
Gracey
AF/type

SS-3-5194
Gracey
MF/type
Fig. 1/2

SS-3-5195
Gracey
MF/type
Fig. 3/4

SS-3-5196
Gracey
MF/type
Fig. 5/6

SS-3-5197
Gracey
MF/type
Fig. 7/8

SS-3-5198
Gracey
MF/type
Fig. 11/12

SS-3-5199
Gracey
MF/type
Fig. 13/14

SS-3-5200
Gracey
MF/type
Fig. 15/16

Gracey Curettes AF Type

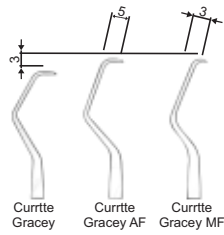

SS-3-5201
Gracey
MF/type
Fig. 1/2



SS-3-5202
Gracey
MF/type
Fig. 3/4



SS-3-5203
Gracey
MF/type
Fig. 5/6



SS-3-5204
Gracey
MF/type
Fig. 7/8



SS-3-5205
Gracey
MF/type
Fig. 11/12



SS-3-5206
Gracey
MF/type
Fig. 13/14



SS-3-5207
Gracey
MF/type
Fig. 15/16



SS-3-5208
Goldman - Fax
Fig. 1



SS-3-5209
Goldman - Fax
Fig. 2



SS-3-5210
Goldman - Fax
Fig. 3



SS-3-5211
Goldman - Fax
Fig. 4



SS-3-5212
Goldman - Fax
Fig. 21

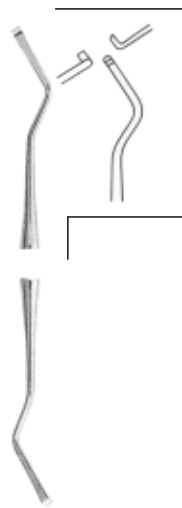

SS-3-5213
Goldman - Fax
Fig. 5



SS-3-5214
Mc Call
Fig. 13S/14S

SS-3-5215
Younger-Good
Fig. 7/8

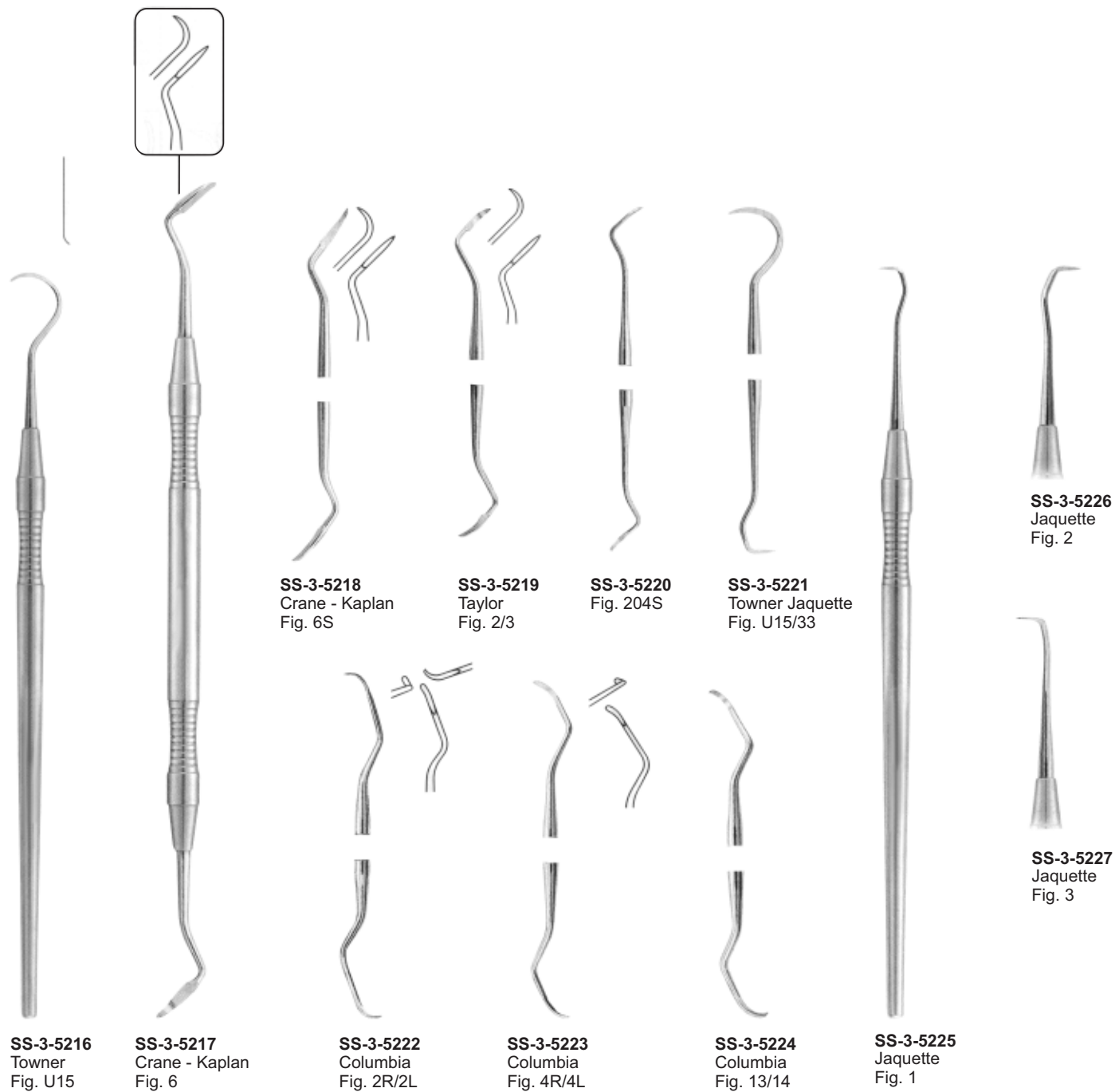



SS-3-5228
Hemingway
Fig. 1



SS-3-5229
Hemingway
Fig. 2



SS-3-5230
Hemingway
Fig. 3



SS-3-5231
Lucas
Fig. 85



SS-3-5232
Lucas
Fig. 86



SS-3-5233
Lucas
Fig. 87



Page
75-77

- Modelling Instruments & Measuring Instruments



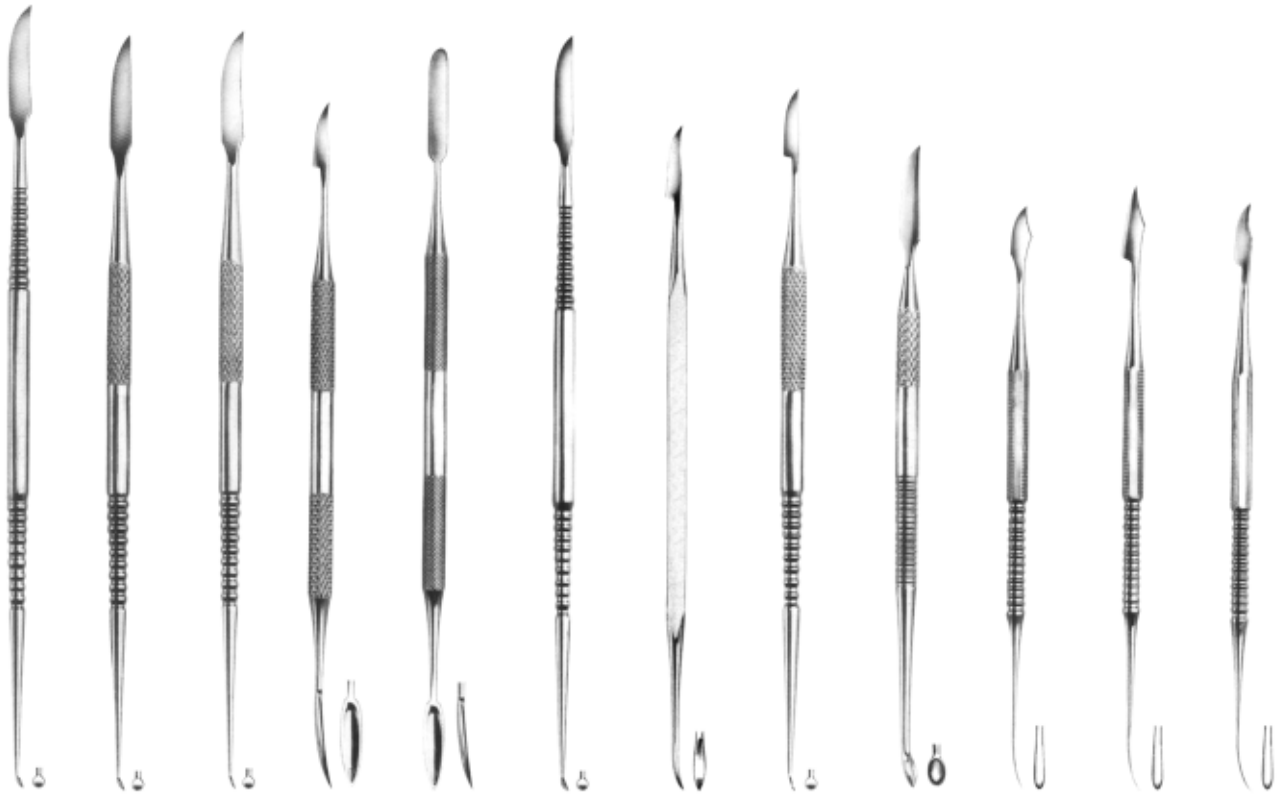

SS-4-5101 Le Cron **SS-4-5102** Le Cron **SS-4-5103** Le Cron **SS-4-5104** MSY **SS-4-5105** MSY **SS-4-5106** Le Cron **SS-4-5107** Hylin **SS-4-5108** Hylin **SS-4-5109** Hylin **SS-4-5110** Zahle **SS-4-5111** Zahle **SS-4-5112** Zahle

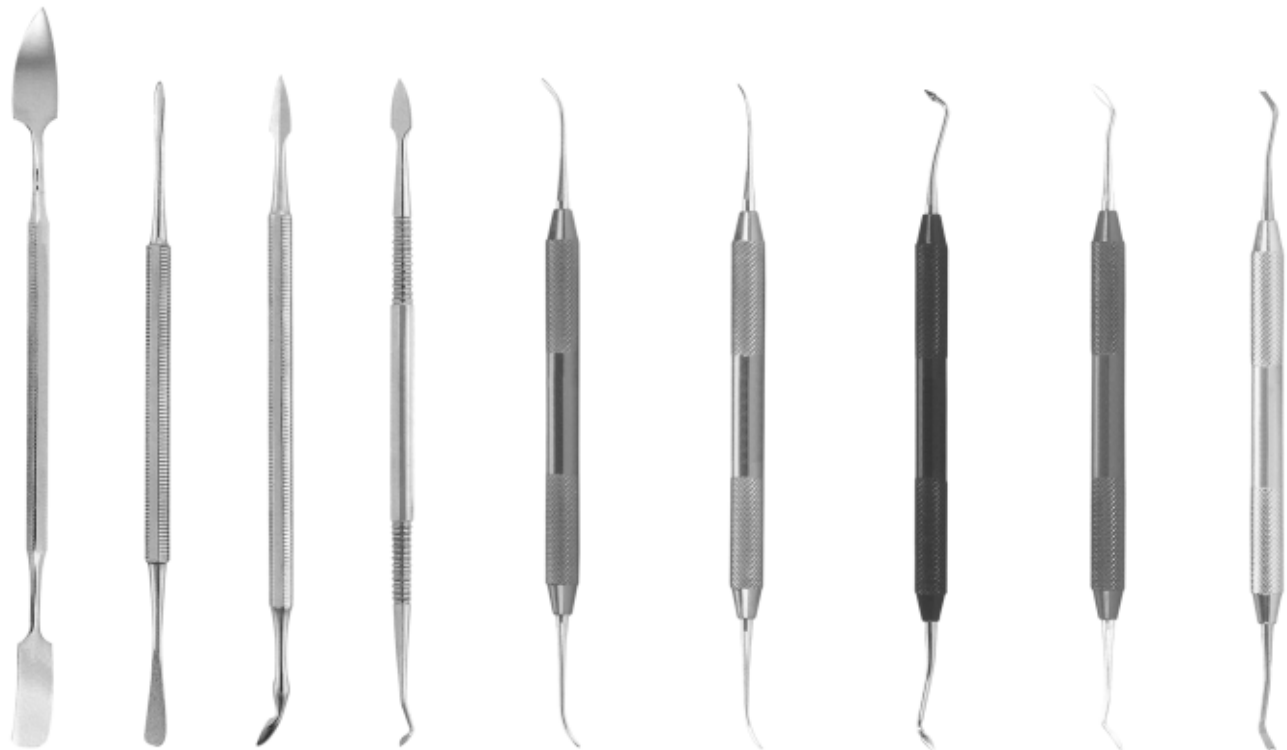

SS-4-5113 Gritman **SS-4-5114** Beale **SS-4-5115** Roach **SS-4-5116** Vehe **SS-4-5117** P.K. Thomas Fig. 1 **SS-4-5118** P.K. Thomas Fig. 2 **SS-4-5119** P.K. Thomas Fig. 3 **SS-4-5120** P.K. Thomas Fig. 4 **SS-4-5121** P.K. Thomas Fig. 5



SS-4-5122
Boley



SS-4-5123
Zuricher
130 mm



SS-4-5124
Vernier
12 cm



SS-4-5125
Vernier

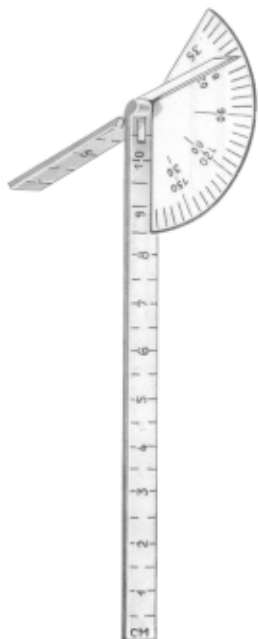

SS-4-5126
Caroll



SS-4-5127
Castroviejo's
Scleral Marker



SS-4-5128
Iwanson

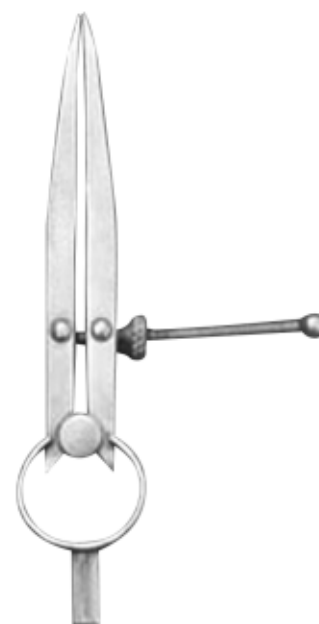

SS-4-5129
Albee



SS-4-5130
18 cm
7 1/8"



SS-4-5131
18 cm
7 1/8"



SS-4-5132
17 cm
6 3/4"
Gritman

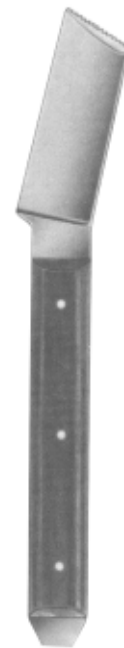

SS-4-5133
17 cm
6 3/4"
Medicon



SS-4-5134
22 cm
8 3/4"



SS-4-5135
Antkoviak



SS-4-5136
Ermert



SS-4-5137
Ermert



Page
78–79

▪ Wax Knives/plaster





SS-4-5138
Fahnenstock
Fig. 1
12,5cm



SS-4-5139
Fahnenstock
Fig. 2
17cm



SS-4-5140
Lessmann
Fig. 1
12,5cm



SS-4-5141
Lessmann
Fig. 2
17cm



SS-4-5142
Con scodellino
Fig. 1
12,5cm



SS-4-5143
Con scodellino
Fig. 2
17cm



SS-4-5144
Fig. 1
17 cm



SS-4-5145
Gritman
Fig. 2
17 cm



SS-4-5146
Fig. 3
16 cm

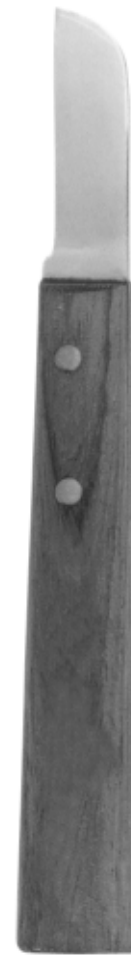

SS-4-5147
Fig. 4
16 cm



Page
80–85

▪ Diagnostic, Explorer, Endodontic Instruments



Explorers



SS-4-5148
Fig 23



SS-4-5149
Fig 6



SS-4-5150
Fig 8



SS-4-5151
Fig 9



SS-4-5152
Fig 17



SS-4-5153
Fig 3
Rein



SS-4-5154
Fig 23/17



SS-4-5155
Fig 17

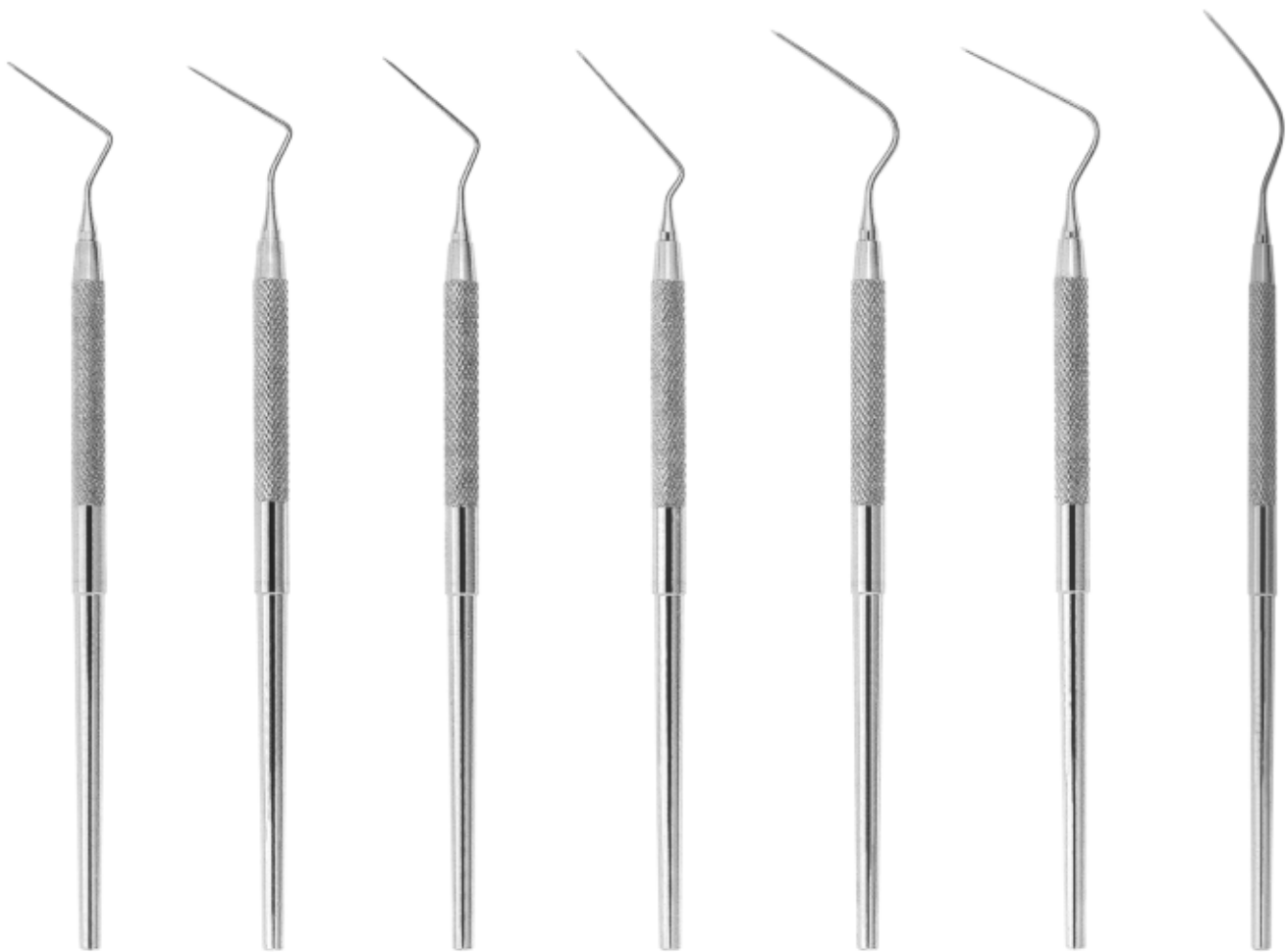

SS-4-5156
Fig.1
Spreader

SS-4-5157
Fig.2
Spreader

SS-4-5158
Fig.3
Spreader

SS-4-5159
Fig.4
Spreader

SS-4-5110
Fig.5
Spreader

SS-4-5111
Fig.6
Spreader

SS-4-5112
Fig.7
Spreader

Double-Ended Root Canal Explorers Plugger/Spreaders

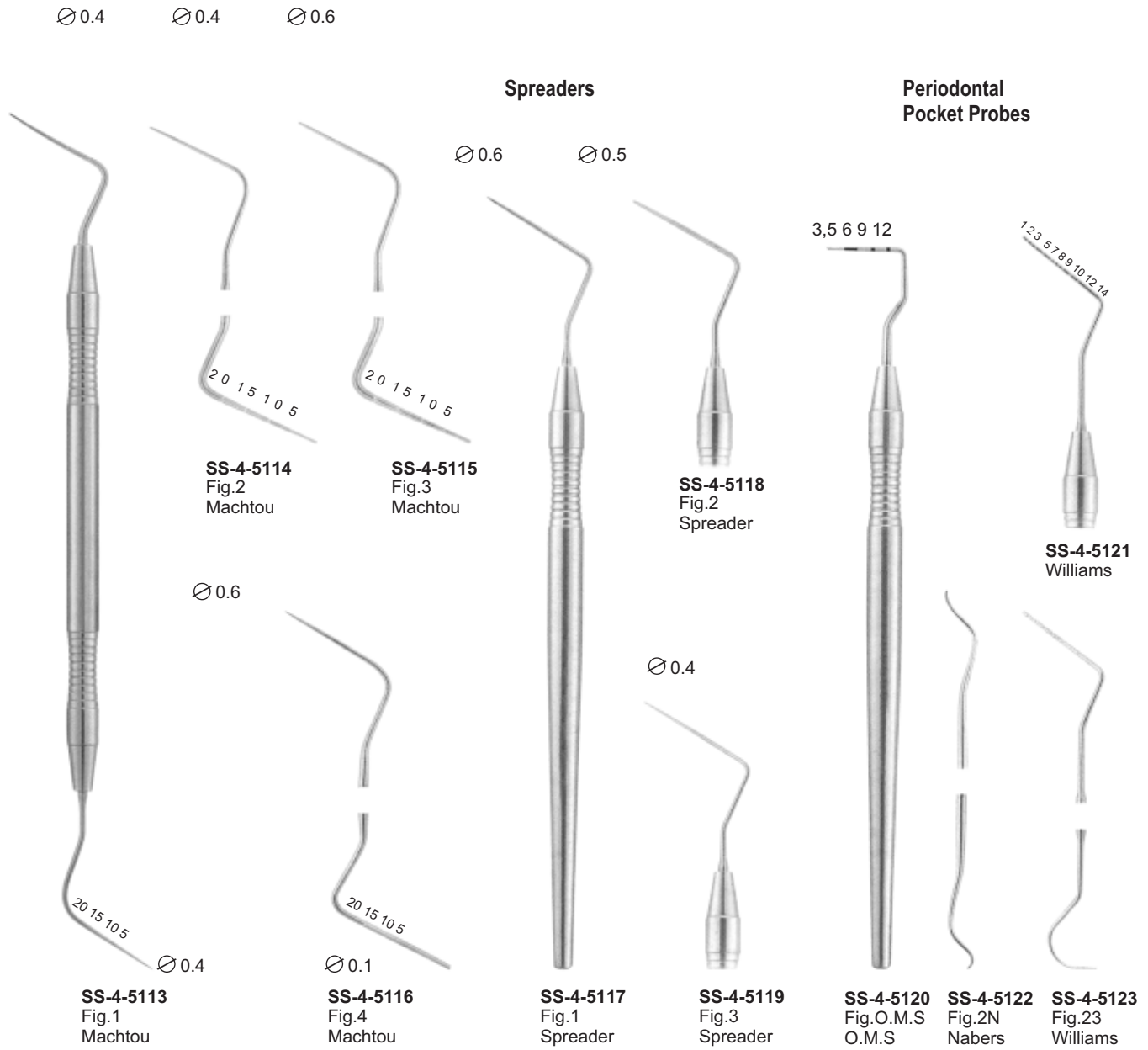

Root-canal pluggers

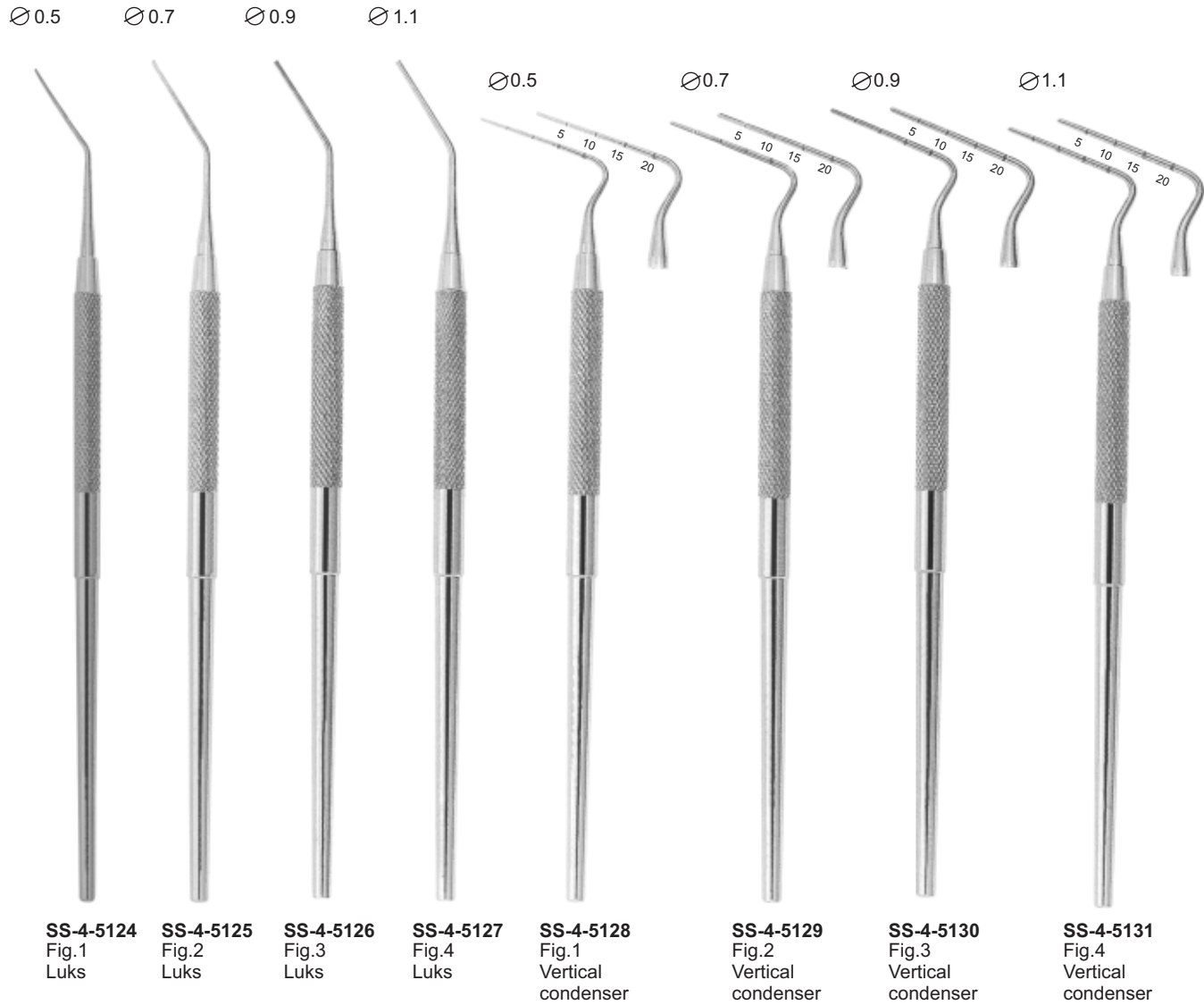

Endodontic set

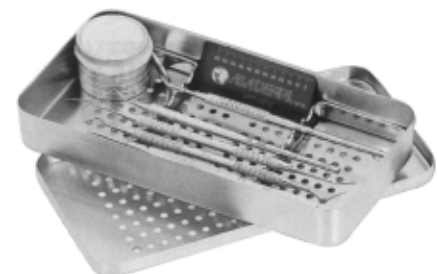

SS-4-5132
MeasuringPlate

Root-canal pluggers

Optimum Flexibility
Very Fine Points

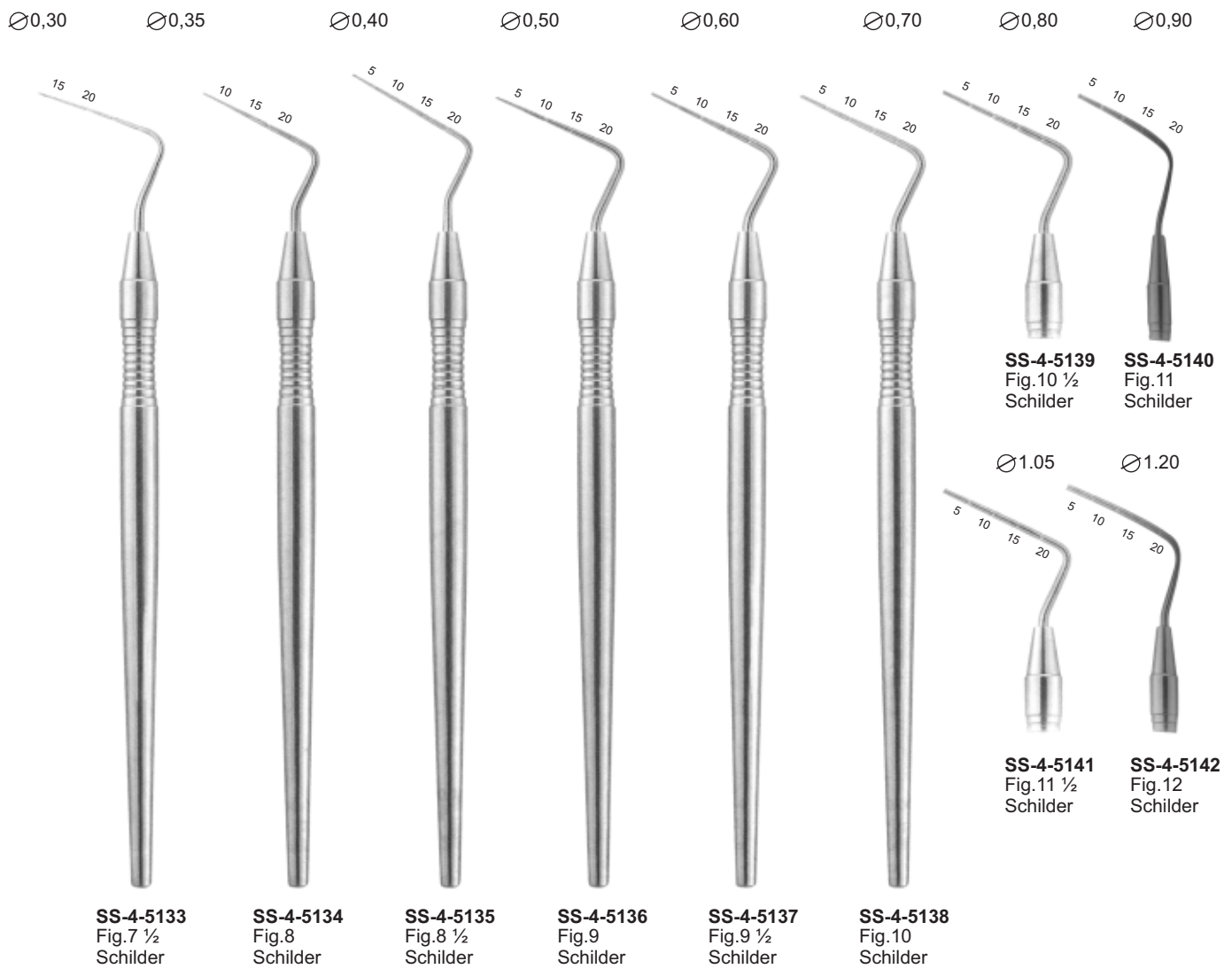

Root-canal explorers

Root-canal excavators



SS-4-5143
Fig.6/1



SS-4-5144
Fig.6/17



SS-4-5145
Fig.6/23



SS-4-5146
Fig.31L



SS-4-5147
Fig.32L



SS-4-5148
Fig.33L



Page
86-87

- Excavators



1 mm



SS-4-5149
Fig 5

1.2 mm



SS-4-5150
Fig 14

1 mm



SS-4-5151
Fig 17

1.2 mm



SS-4-5152
Fig 18

1.6 mm



SS-4-5153
Fig 19

2 mm



SS-4-5154
Fig 20

1 mm



SS-4-5155
ASH
Fig.243

1,4 mm



SS-4-5156
ASH
Fig.G2

0,8 mm



SS-4-5157
Fig.1

0,8 mm



SS-4-5158
Fig.2

1 mm



SS-4-5159
Fig.11

1 mm



SS-4-5160
Fig.12

1,2 mm



SS-4-5161
Fig.21

1,2 mm



SS-4-5162
Fig.22

1,6 mm



SS-4-5163
Fig.31

1,6 mm



SS-4-5164
Fig.32

2 mm



SS-4-5165
Fig.41

2 mm



SS-4-5166
Fig.42



Page
88–89

- Handles For Mouth Mirrors



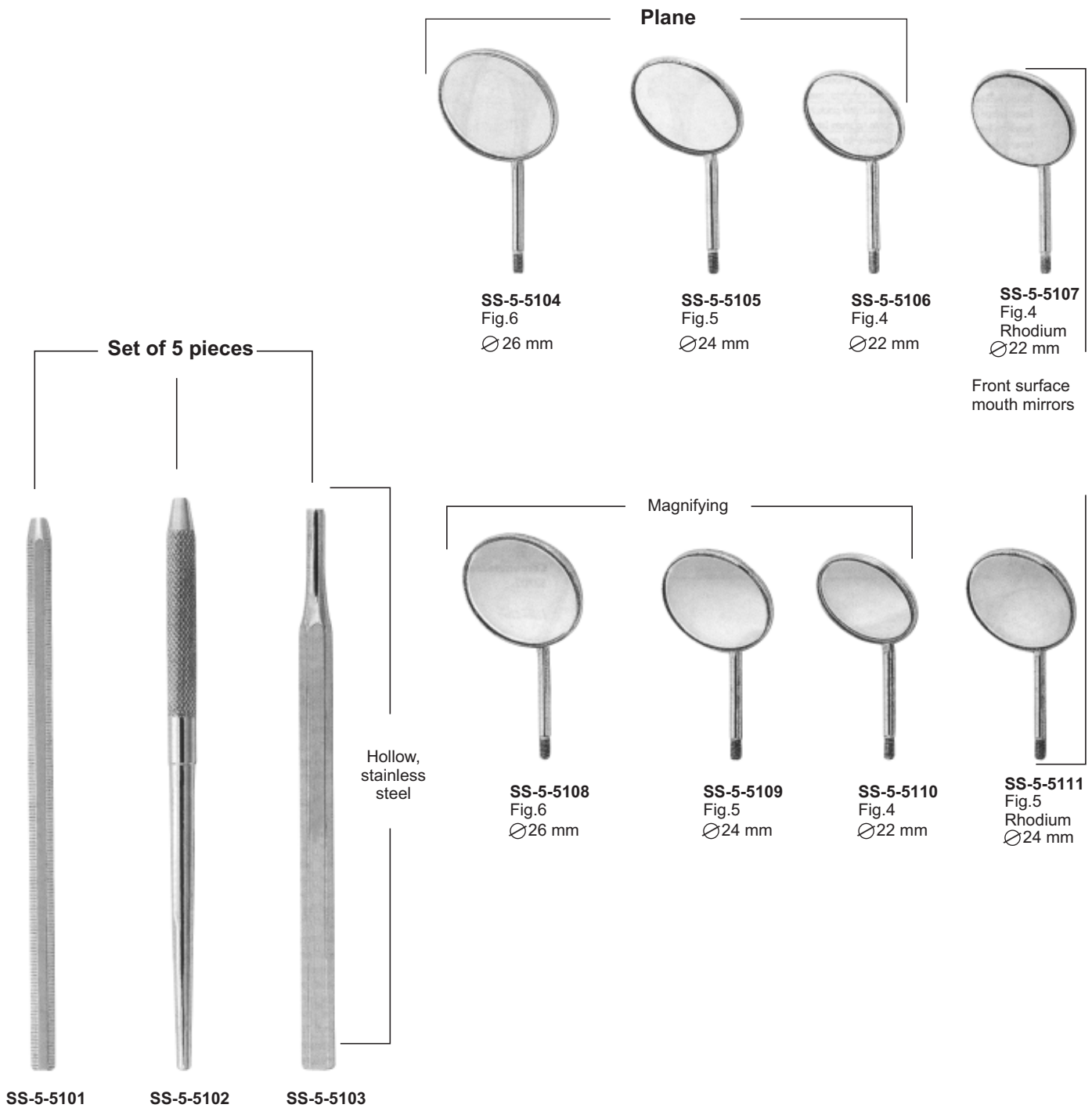



SS-5-5112



SS-5-5113



SS-5-5114



SS-5-5115



SS-5-5116



SS-5-5117
Parallelometer
mouth mirror

SS-5-5118
Parallelometer
mouth mirror
+ handle
code 2101

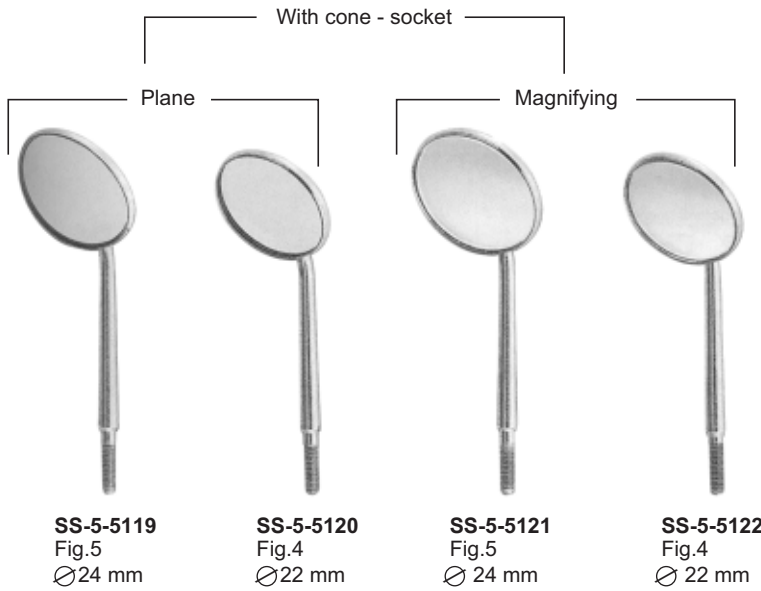

SS-5-5119
Fig.5
Ø24 mm

SS-5-5120
Fig.4
Ø22 mm

SS-5-5121
Fig.5
Ø 24 mm

SS-5-5122
Fig.4
Ø 22 mm



SS-5-5123
Cone - socket



SS-5-5124
Cone - socket



SS-5-5125
Cone - socket



Page
90–93

- Spatulas



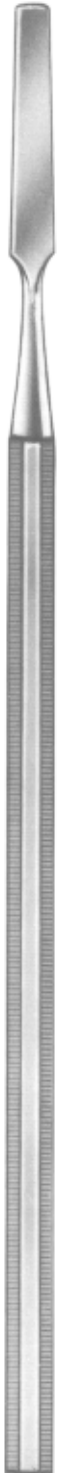

SS-5-5126

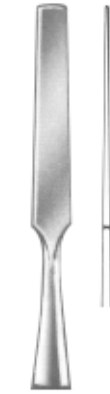

SS-5-5127



SS-5-5128



SS-5-5129

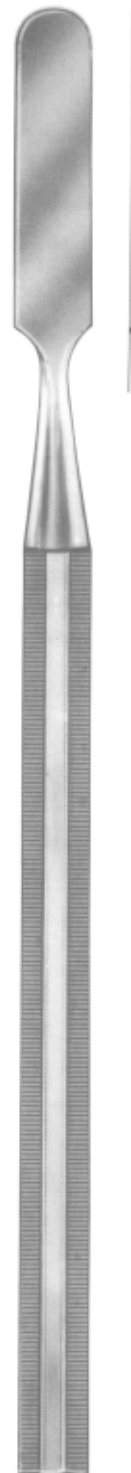

SS-5-5130



SS-5-5131



SS-5-5132



SS-5-5133

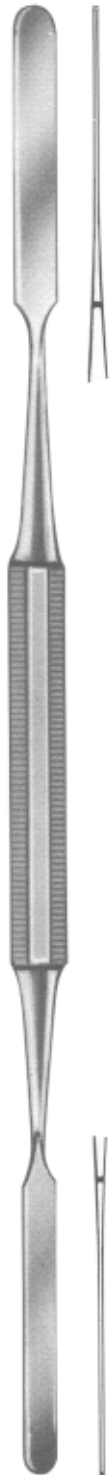

SS-5-5134



SS-5-5135



SS-5-5136

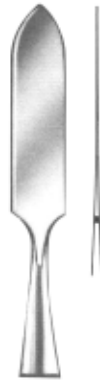

SS-5-5137



SS-5-5138



SS-5-5139



SS-5-5140



SS-5-5136



SS-5-5137



SS-5-5138



SS-5-5139



SS-5-5140



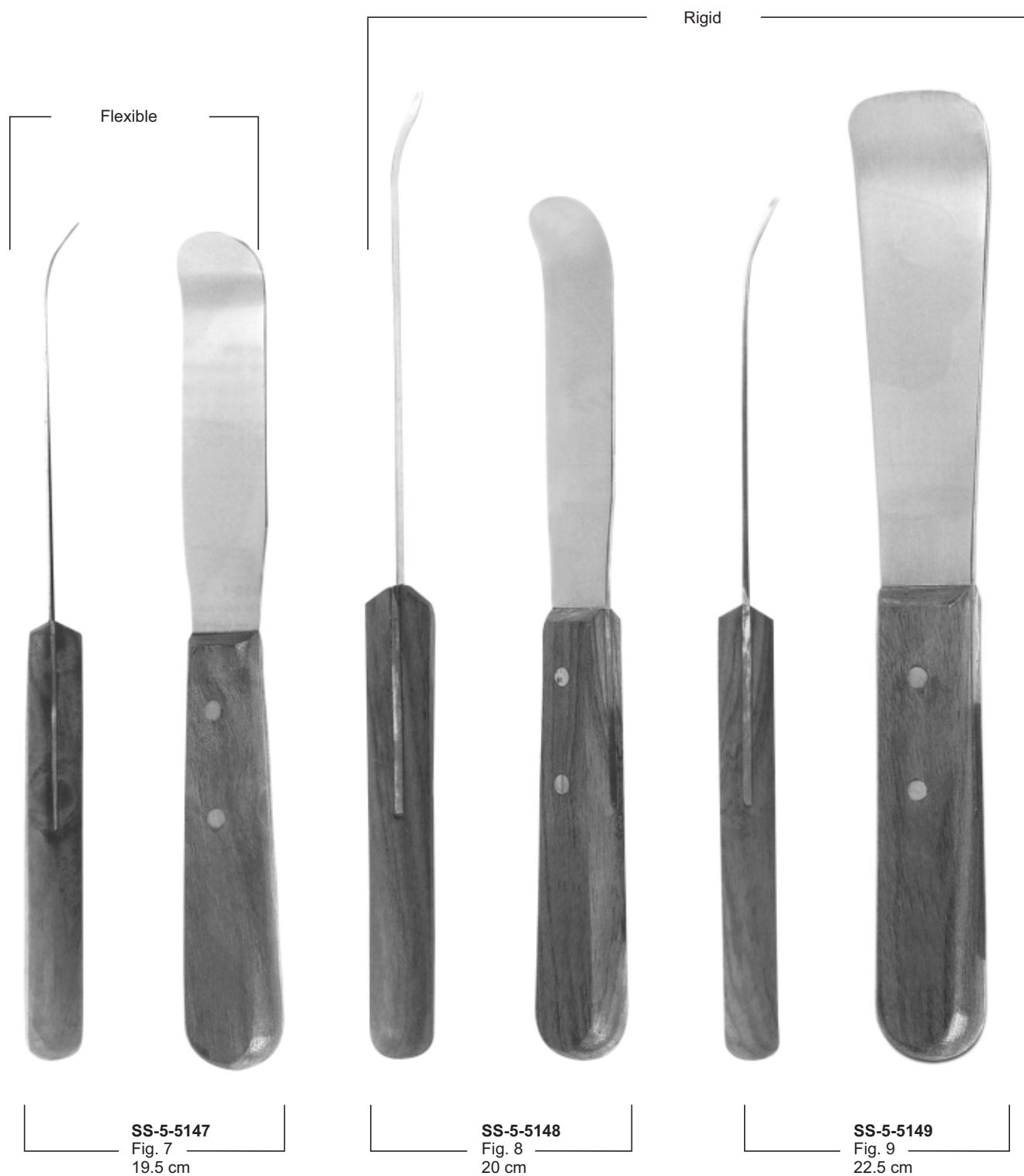



Page 94-100

- Needle Holders





SS-5-5150
Mayo-Hegar
16 cm



SS-5-5151
Mayo-Hegar TC
16 cm



SS-5-5152
Mayo-Hegar
18 cm



SS-5-5153
Mayo-Hegar TC
18 cm



SS-5-5154
Mini-Ryder
18 cm



SS-5-5155
Mini-Ryder
15 cm



SS-5-5156
Derf
12 cm



SS-5-5157 Hegar-
Baumgarther 14 cm



SS-5-5158
Crile-Wood
15 cm



SS-5-5159
Crile-Wood TC
15 cm



SS-5-5160
Adson
17.5 cm



SS-5-5161
Olsen-Hegar
14 cm



SS-5-5162
Baumgarther
14.5 cm



SS-5-5163
Gillies
16 cm



SS-5-5164
Gillies
16 cm



SS-5-5165 Hegar-
Baumgarther 14 cm



SS-5-5166
Toennis
18 cm



SS-5-5167
Toennis
18 cm



SS-5-5168
Lichtenberg
17 cm



SS-5-5169
Lichtenberg
17 cm



SS-5-5170
Eiselberg-Mathieu
19.5 cm



SS-5-5171
Boynton
12 cm



SS-5-5172
Arruga
16 cm



SS-5-5173
Boynton
12 cm



SS-5-5174
Arruga
16 cm



SS-5-5175
Castroviejo
14 cm



SS-5-5176
Castroviejo
14 cm



SS-5-5177
Castroviejo
14/60 cm



SS-5-5178
Castroviejo
18 cm



SS-5-5179
Castroviejo
18 cm



SS-5-5180
Castroviejo
14 cm



SS-5-5181
Castroviejo
14 cm



SS-5-5182
Castroviejo
14/60 cm



SS-5-5183
Castroviejo
18 cm



SS-5-5184
Castroviejo
18 cm



SS-5-5185
Mathieu
14 cm



SS-5-5186
Mathieu
14 cm



SS-5-5187
Mathieu
14 cm



SS-5-5188
Mathieu
14 cm



SS-5-5189
Mathieu
17 cm



SS-5-5190
Mathieu
17 cm



SS-5-5191
Mathieu
14 cm



SS-5-5192
Micro-Barraquer
18 cm



The tips have tungsten carbide inserts for better handling.



SS-5-5193
Mathieu
17 cm



SS-5-5194
Mathieu
17 cm



SS-5-5195
Micro-Barraquer
14 cm



SS-5-5196
Castroviejo
13 cm



SS-5-5197
Castroviejo-Barraquer
13 cm



SS-5-5198
Castroviejo
13 cm



SS-5-5199
Castroviejo
13 cm



SS-5-5200
18.03mm,cm



SS-5-5201
18.04mm,cm



SS-5-5202
18.05mm,cm



SS-5-5206
Fig.6FR
Fraizer
15.02mm,cm

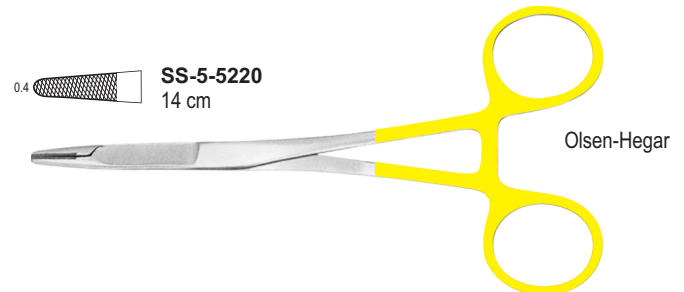
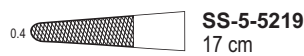
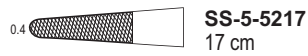
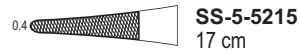
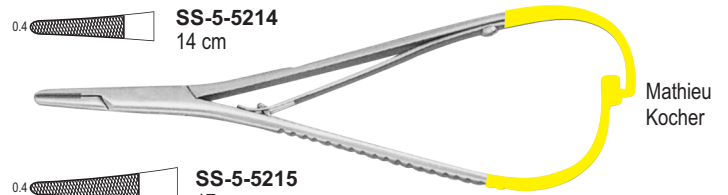
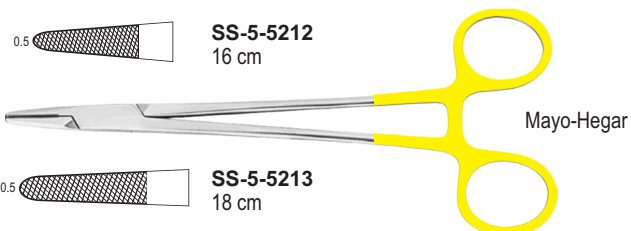
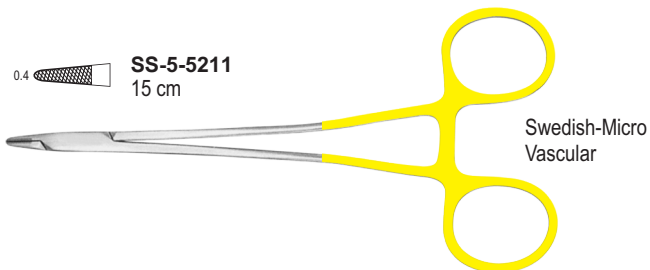
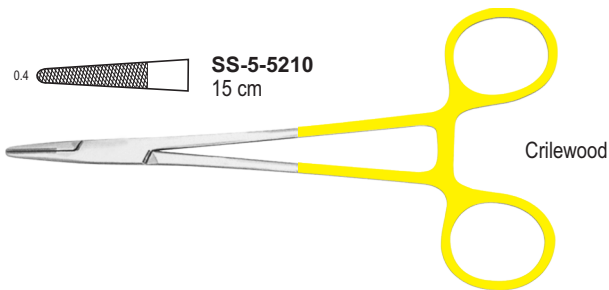
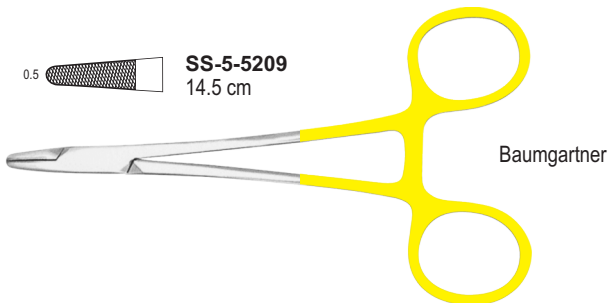
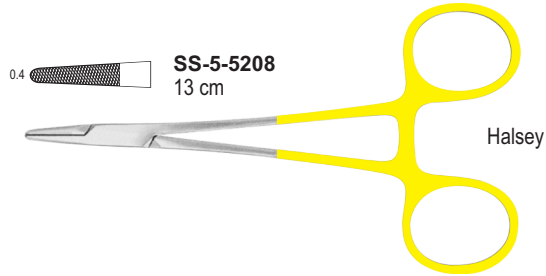
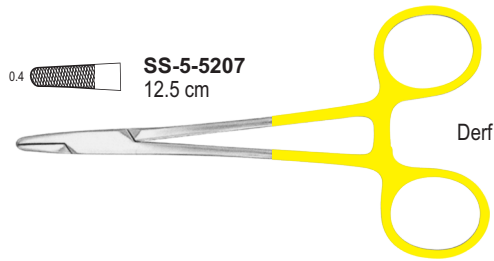



Page 101-109

- Syringes and Scissors



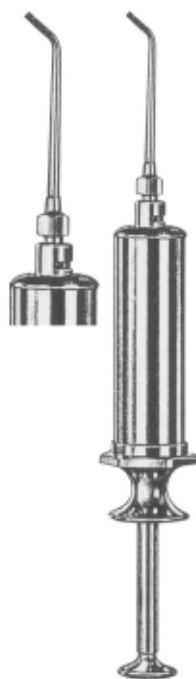

SS-5-5222

Water Syringe complete with 1 cannula (Lure-Lock)



SS-5-5223

Water Syringe complete with 1 cannula (Lure-Lock)



SS-5-5224

Metal water syringe, self-filling, with 1 cannula (Lure-Lock)



SS-5-5225

Sparrel Barrel with plunger suitable for syringes



SS-5-5226 Cannula, only, with

Luer-Lock connector suitable for syringes



SS-5-5227
Aspirating Syringe

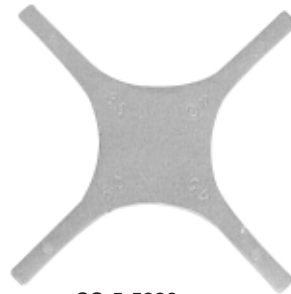

SS-5-5228
Position Gauge

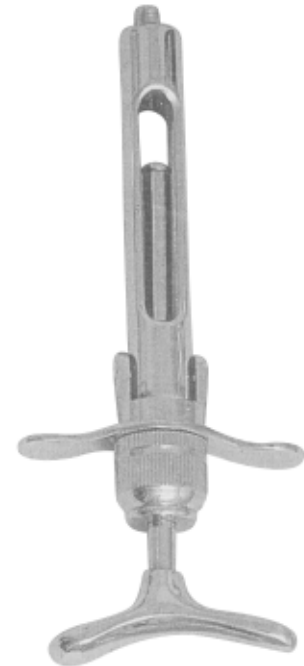

SS-5-5229
Breech Loading Syringe



SS-5-5230
Aspirating & Breech Syringe



SS-5-5231
Band Adaptor



SS-5-5232
Endo Finger Ruler
With Adjustable Slide



SS-5-5233
Aspirating Syringe



SS-5-5234



SS-5-5235



SS-5-5236

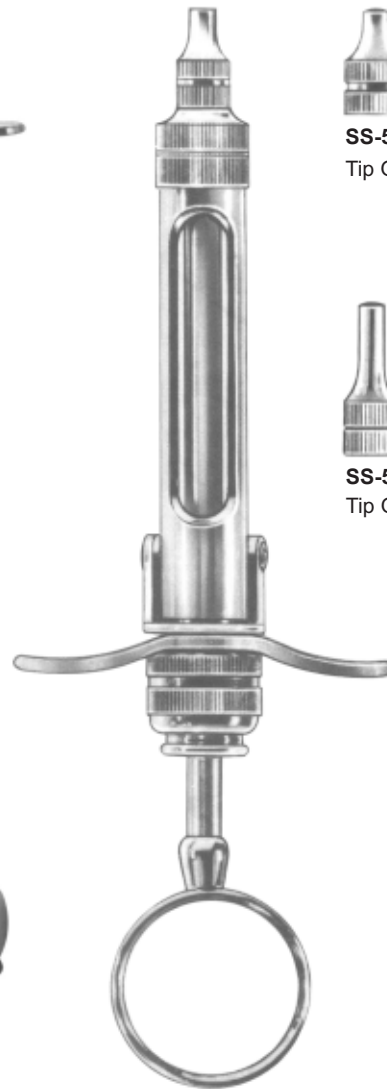

SS-5-5237 1,8 ml

SS-5-5238 2,2 ml

Cartridge Syringe complete
With 2 tips and without needles



SS-5-5239

Tip Only, short



SS-5-5240

Tip Only, long



SS-5-5241



SS-5-5242



SS-5-5243



SS-5-5244
Cork screw tip



SS-5-5245
Cork screw tip



SS-5-5246
Folding type, cork
screw tip



SS-5-5247
Folding type, cork
screw tip



SS-5-5248



SS-5-5249
Cork screw tip



SS-5-5250
Spare cap with
metric thread



SS-5-5251
With Whitworth
thread



AS-5252
Autoclavable Plastic Protection sleeve



SS-5-5253
Brass syringe with stainless steel moving parts

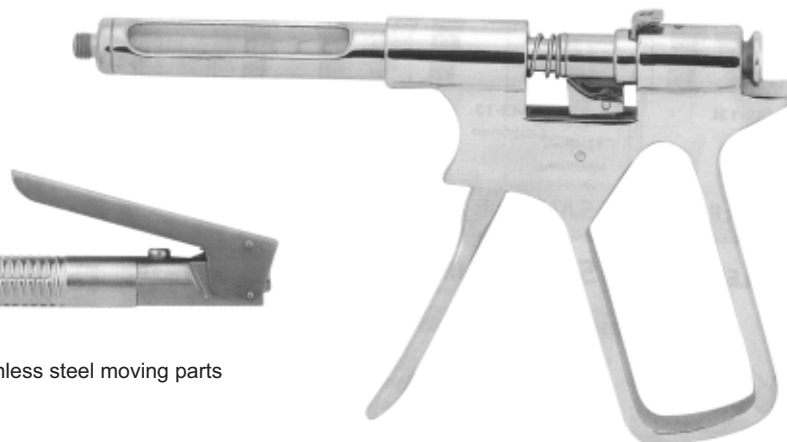

SS-5-5254
Brass syringe with stainless
steel moving parts



Suture Scissors | Tijeras para Hilos | Fadenscheren

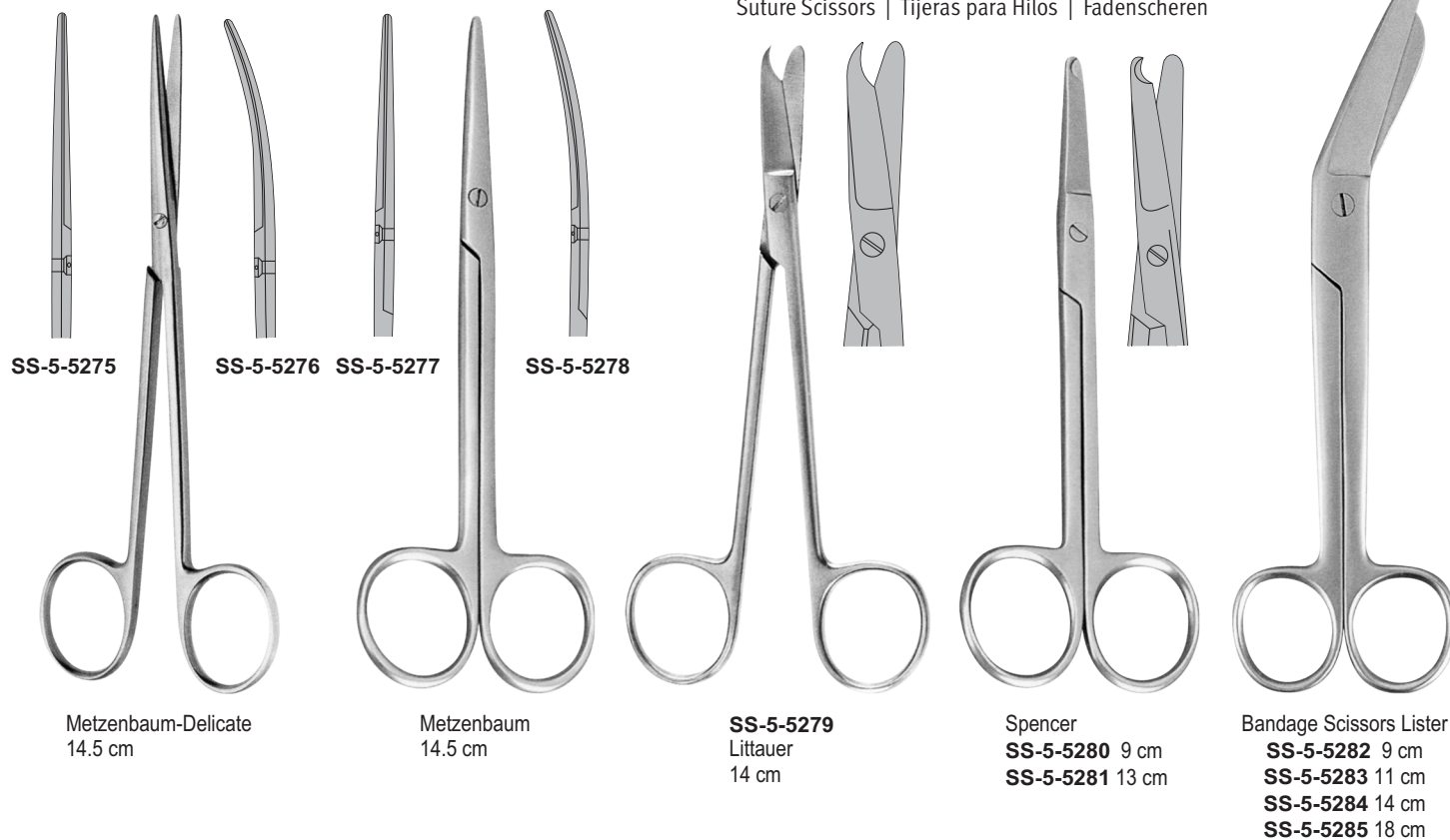



Iris
11.5 cm

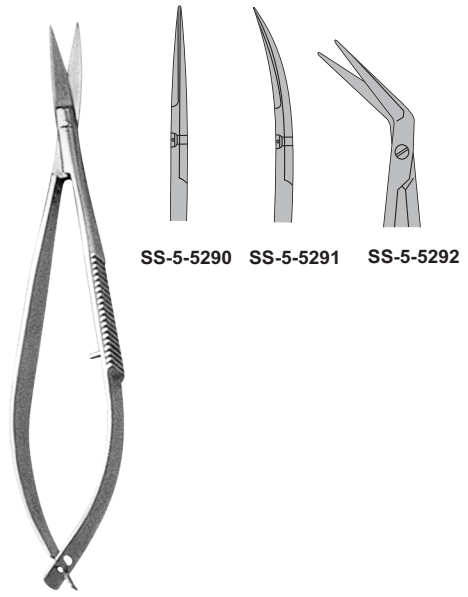

Noyes / Castroviejo
12 cm

SS-5-52903
La Grange
11.5 cm



SS-5-5294
Universal
18 cm

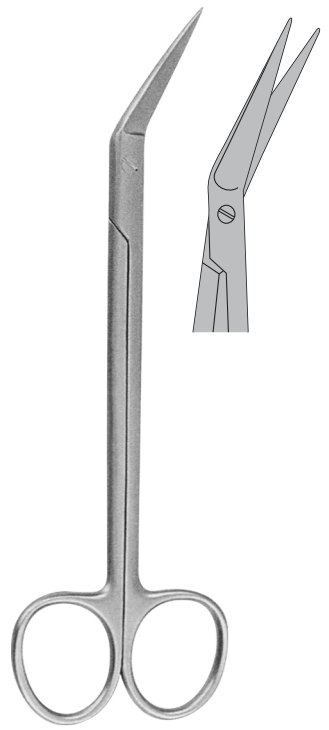

SS-5-5295
Kelly
16 cm

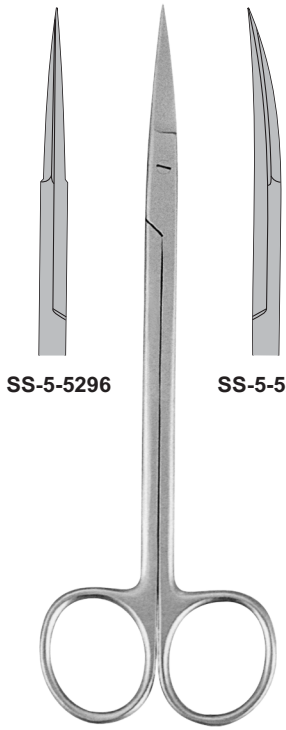

Kelly
16 cm



SS-5-5298
Goldman-Fox
13 cm

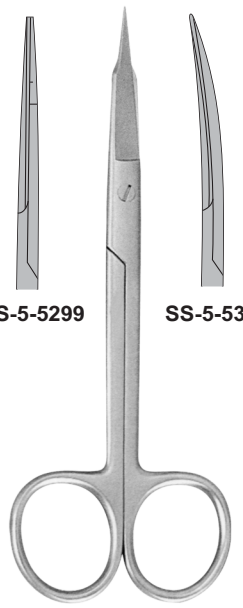

Goldman-Fox
13 cm

Scissors, One Blade Serrated

- One blade is with fine serrations to avoid tissue or ligature slippage.
- Manufactured from high quality stainless steel to provide longer-lasting cutting edge.
- Single black ring for easy identification.



Iris
11.5 cm



Goldman-Fox
13 cm

SS-5-5306
Goldman-Fox
13 cm

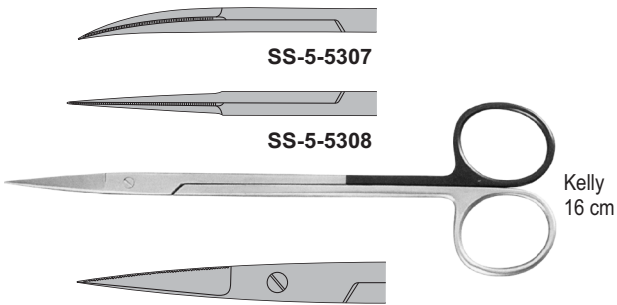

Kelly
16 cm

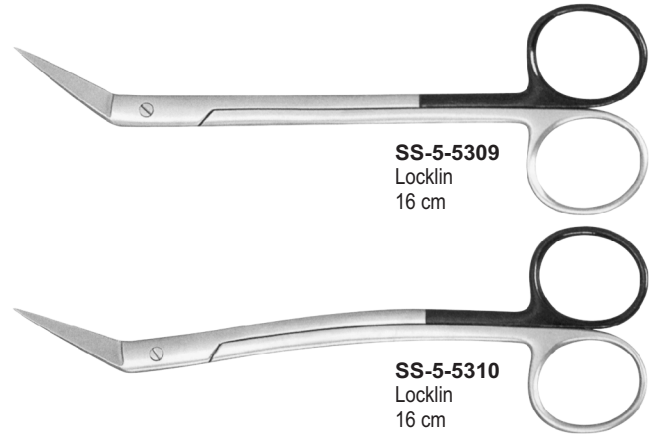

SS-5-5309
Locklin
16 cm

SS-5-5310
Locklin
16 cm

Super-Cut

- Cutting Blade horned to "razor" sharpness with opposing blade finished with fine serrations to avoid tissue slippage.
- Extremely smooth cutting with less trauma.
- Manufactured from high quality stainless steel to provide longer-lasting cutting edge.
- Single gold plated ring for easy identification.



Iris
11.5 cm



SS-5-5313
La Grange
11.5 cm



Goldman-Fox
13 cm



SS-5-5316 SS-5-5317



Iris
11.5 cm

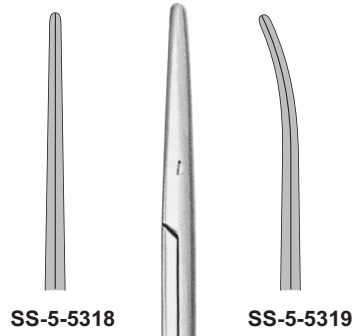

SS-5-5318 SS-5-5319



Metzenbaum
14.5 cm

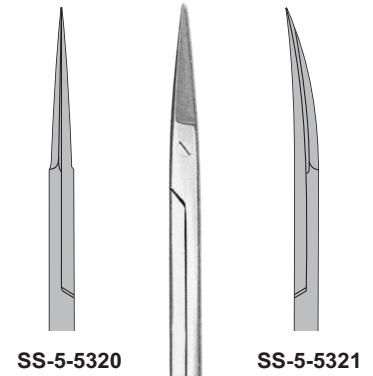

SS-5-5320 SS-5-5321



Kelly
16 cm

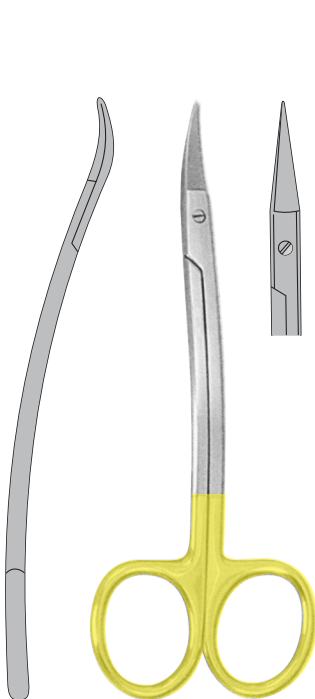

SS-5-5322
La Grange
11.5 cm

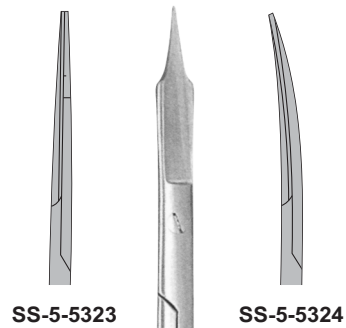

SS-5-5323 SS-5-5324



Goldman-Fox
13 cm

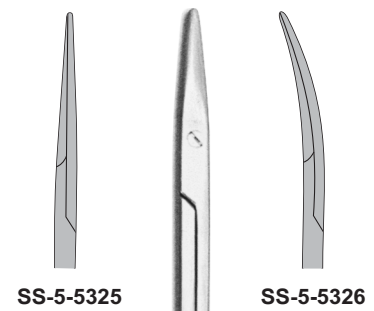

SS-5-5325 SS-5-5326



Strabismus
11.5 cm

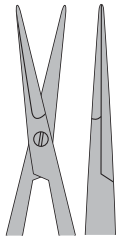
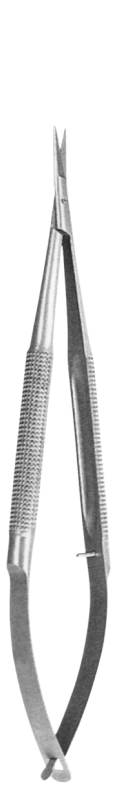

SS-5-5327
15 cm

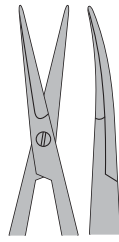

SS-5-5328
15 cm

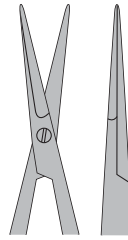
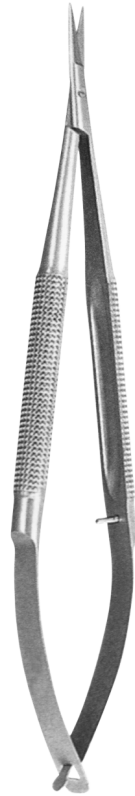

SS-5-5329
18 cm

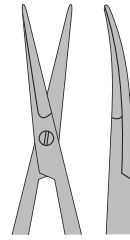

SS-5-5330
18 cm

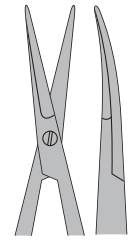
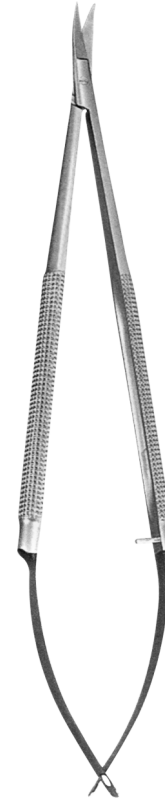

SS-5-5331
18 cm

Micro Scissor
Stainless Steel

Micro Scissor
Stainless Steel

Micro Scissor
Stainless Steel
for ligature, one blade serrated

Micro Scissors with Titanium Stainless Steel Tips

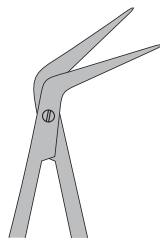

SS-5-5332
18 cm

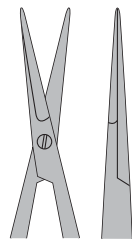

SS-5-5333
18 cm

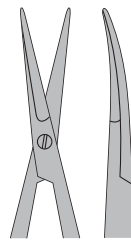

SS-5-5334
18 cm

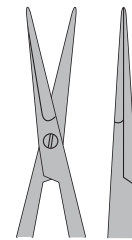

SS-5-5335
15.5 cm

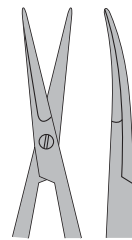

SS-5-5336
15.5 cm



Page
110-114

- Dental Tweezers





smooth

SS-5-5337
College
15 cm

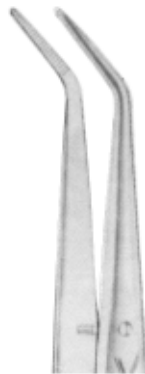

serrated

SS-5-5338
College
15 cm



smooth

SS-5-5339
College
15 cm



serrated

SS-5-5340
College
15 cm



smooth

SS-5-5341
College
15 cm



serrated

SS-5-5342
College
15 cm



smooth

SS-5-5343
College
15 cm



serrated

SS-5-5344
College
15 cm

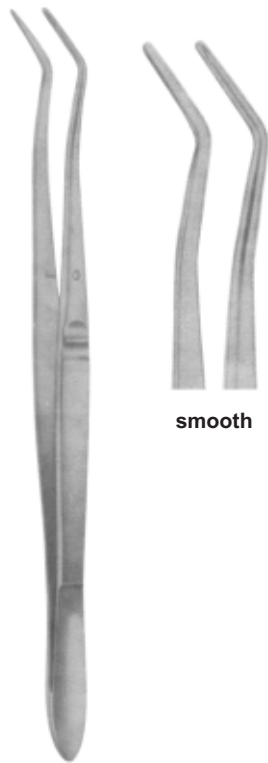

smooth

SS-5-5345
Meriam
16 cm

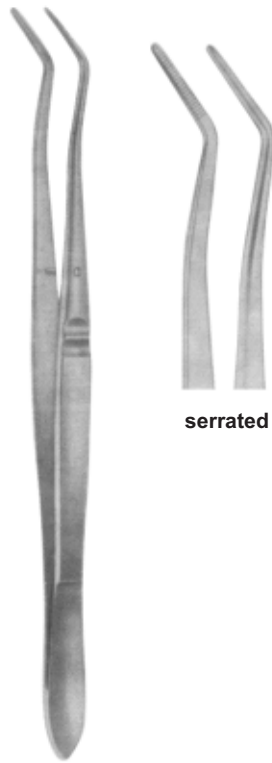

serrated

SS-5-5346
Meriam
16 cm

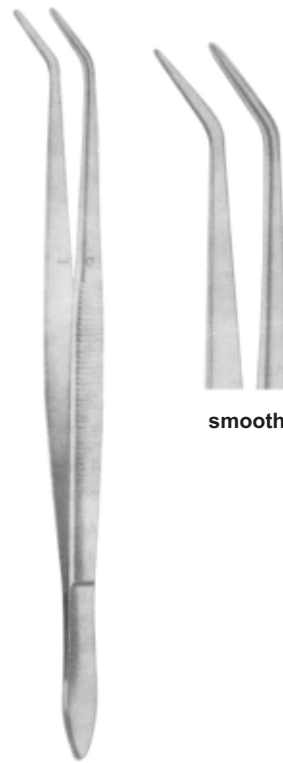

smooth

SS-5-5347
Meriam
16 cm

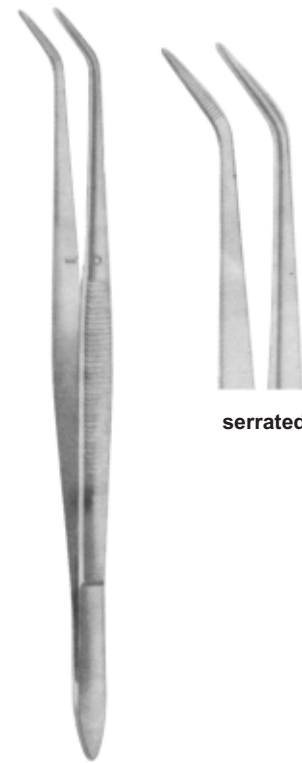

serrated

SS-5-5348
Meriam
16 cm

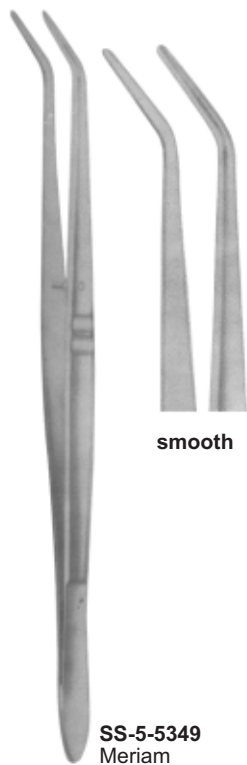

smooth

SS-5-5349
Meriam
16 cm

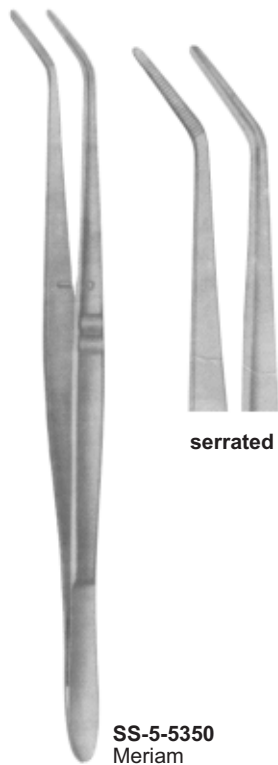

serrated

SS-5-5350
Meriam
16 cm

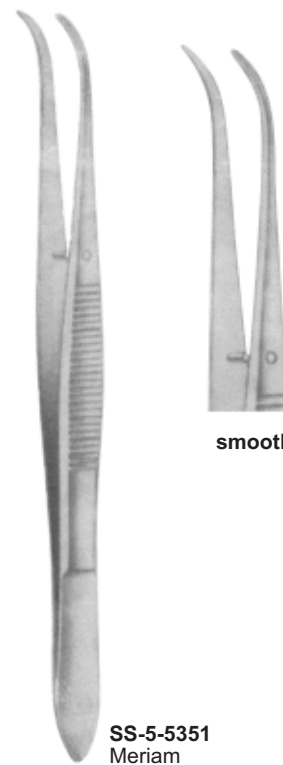

smooth

SS-5-5351
Meriam
16 cm

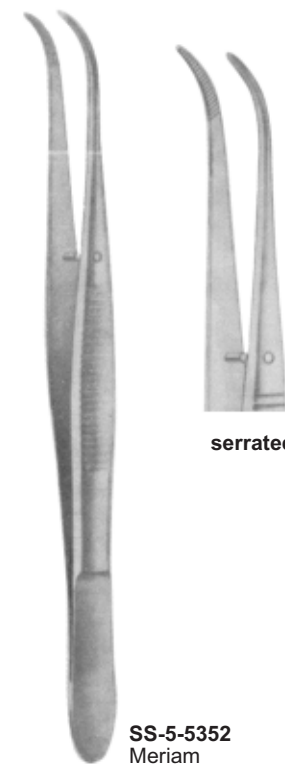

serrated

SS-5-5352
Meriam
16 cm

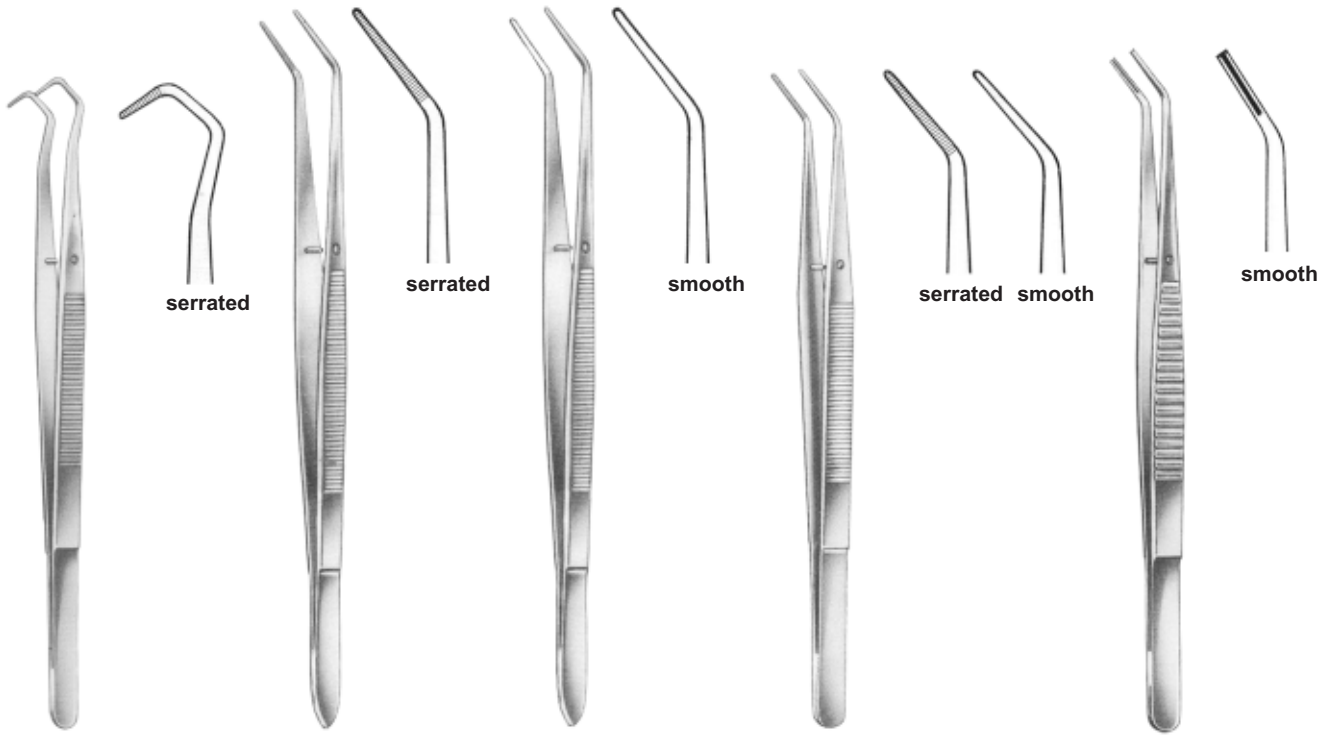

SS-5-5353
College
14.5 cm, 5³/₄"

SS-5-5354
Flagg
16 cm, 6¹/₄"

SS-5-5355
Flagg
16 cm, 6¹/₄"

SS-5-5356
Landgraf
15 cm, 6"

SS-5-5357
15,5 cm, 6¹/₈"

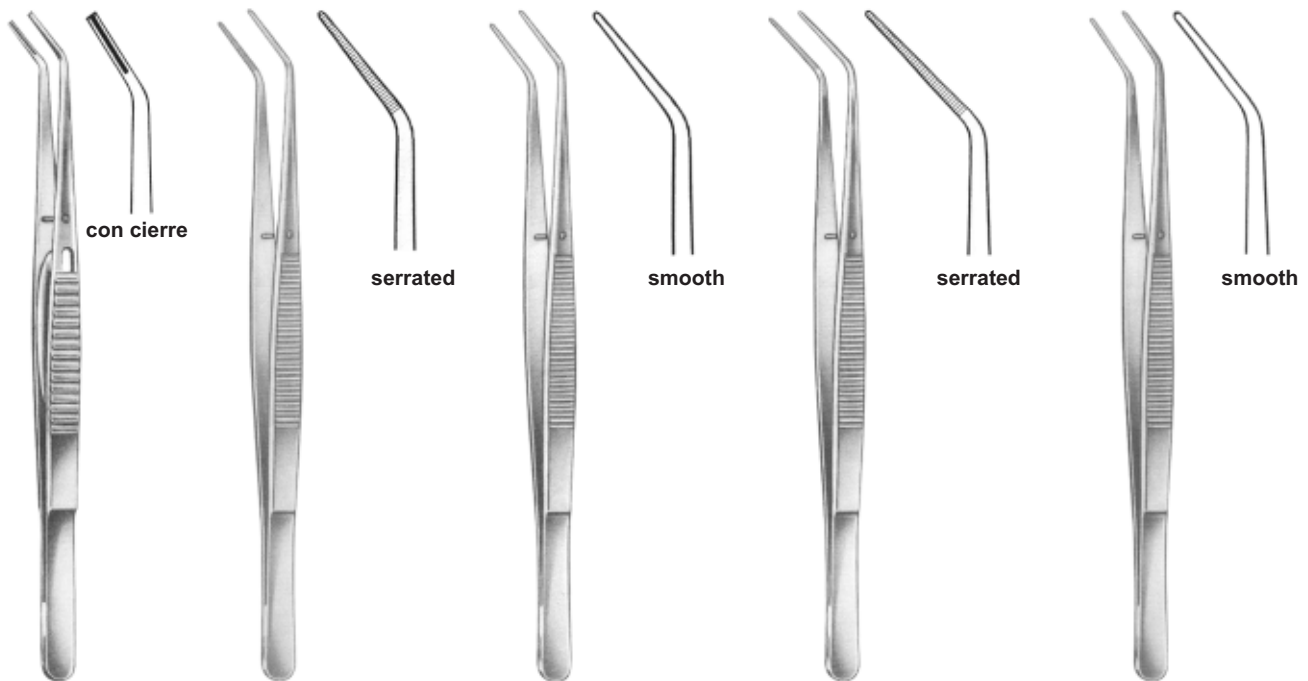

SS-5-5358
15.5 cm, 6¹/₈"

SS-5-5359
London-College
15 cm, 6"

SS-5-5360
London-College
15 cm, 6"

SS-5-5361
London-College
15 cm, 6"

SS-5-5362
London-College
15 cm, 6"



SS-5-5363
CK1
15 cm, 6"

SS-5-5364
CK2
15 cm, 6"

SS-5-5365
GF2
16 cm, 6 1/4"

SS-5-5366
Gf1
16 cm, 6 1/4"

SS-5-5367
Kopp
15.5 cm, 6 1/8"



SS-5-5368
Kopp
15.5 cm, 6 1/8"

SS-5-5369
15 cm, 6"

SS-5-5370
16.5 cm, 6 1/2"

SS-5-5371
15.5 cm, 6 1/8"

SS-5-5372
15.5 cm, 6 1/8"

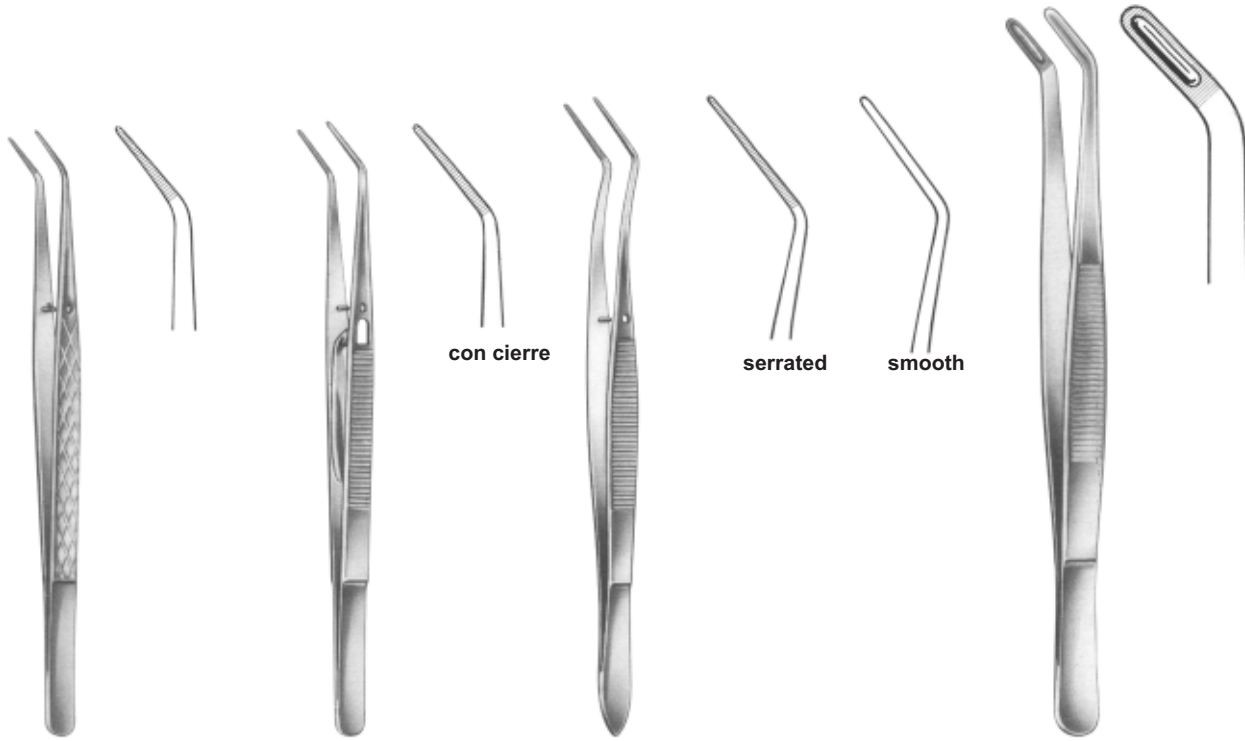

SS-5-5373
London-College
15 cm, 6"

SS-5-5374
London-College
15 cm, 6"

SS-5-5375
Meriam
16 cm, 6 1/4"

SS-5-5376
Allen
18 cm, 7 1/8"



SS-5-5377
Albrecht
16 cm, 6 1/4"

SS-5-5378
Albrecht
16 cm, 6 1/4"

SS-5-5379
16 cm, 6 1/4"

SS-5-5380
16 cm, 6 1/4"

SS-5-5381
16 cm, 6 1/4"



Page
115-117

- Rubber Dam Clamps



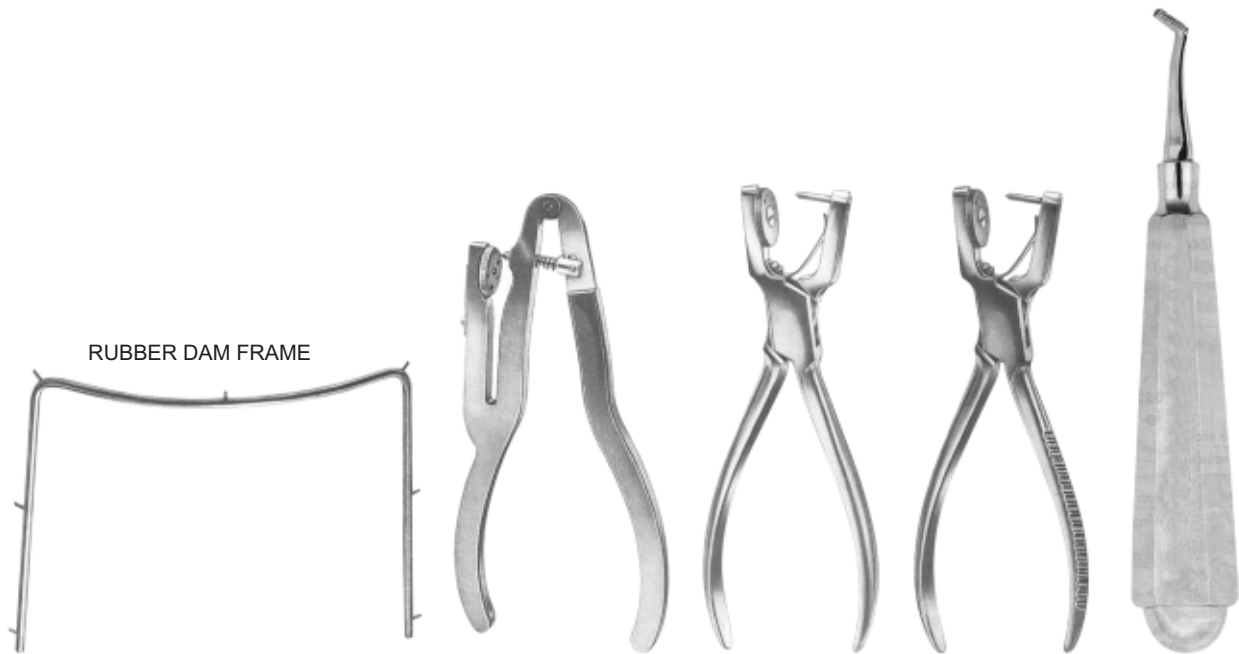

RUBBER DAM FRAME

SS-5-5382
Young
105x95 Inox

SS-5-5383
Ivory
160 mm

SS-5-5384
Ainsworth
170 mm

SS-5-5385
Ainsworth
170 mm

SS-5-5386
Mershan
140 mm

CLAMPS (PLIERS)

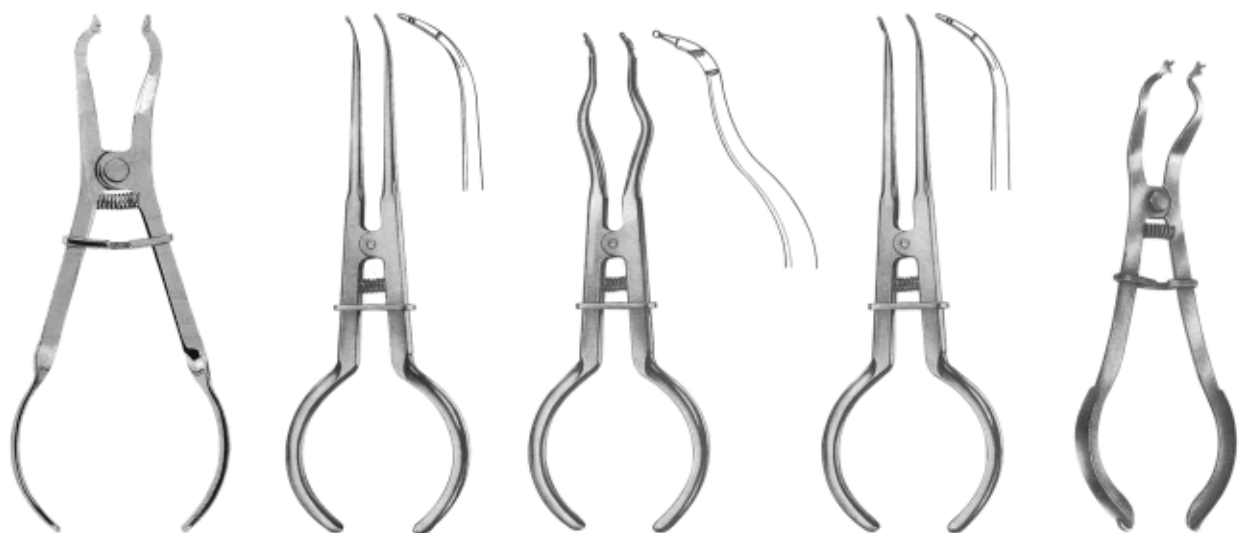

SS-5-5387
Ivory light weight
170 mm

SS-5-5388
Brewer
175 mm

SS-5-5389
Brewer
175 mm

SS-5-5390
White
175 mm

SS-5-5391
Ivory
170 mm



SS-5-5392
Winged
Labial Clamp



SS-5-5393 Winged
Edged Labial Clamp



SS-5-5394
Winged
Cervical Clamp



SS-5-5395
Winged
Labial Clamp



SS-5-5396
Winged



SS-5-5397
Winged



SS-5-5398
Wingless

For Small Teeth, Elongated or With Narrow Collars



SS-5-5399
Winged



SS-5-5400
Winged



SS-5-5401
Wingless

For General Use With Adjustable Jaws According
To Gingival Line Shapes



SS-5-5402
Winged



SS-5-5403
Edged, Winged



SS-5-5404
Wingless

For Premolars, With Elongated Collar



SS-5-5405
Winged



SS-5-5406
Edged, Winged



SS-5-5407
Wingless

For Premolars, With Elongated Collar



SS-5-5408
Wingless



SS-5-5409
Wingless



SS-5-5410
Winged

SS-5-5411
Wingless

SS-5-5412
Winged

SS-5-5413
Wingless

For Small Lower Molars

For Small Lower Molars With Round clamps



SS-5-5414
Winged

SS-5-5415
Wingless

SS-5-5416
Winged

SS-5-5417
Wingless

For Square Lower Molars

For Round Upper Molars



SS-5-5418
Winged

SS-5-5419
Wingless

SS-5-5420
Winged

SS-5-5421
Wingless

For Molar Roots

For Partially Broken Molars



SS-5-5422
Winged

SS-5-5423
Edged Winged

SS-5-5424
Wingless

SS-5-5425
Winged

SS-5-5426
Wingless

For Round Molars, Partially Broken, Undersized or Inclined



SS-5-5427
Wingless

SS-5-5428
Wingless

SS-5-5429
Winged

SS-5-5430
Winged



Page 118-122

- Matrix Retainer
- Matrix Bands



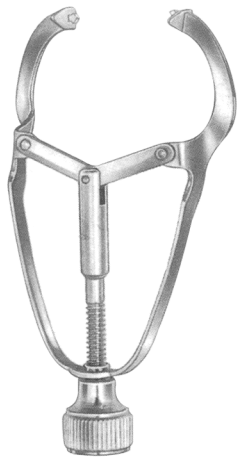

SS-6-5101
Ivory
63mm

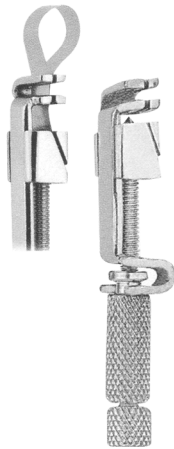

SS-6-5102
Tofflemire-Universal



SS-6-5103
Tofflemire-Junior



SS-6-5104
Tofflemire-Senior



SS-6-5105
Ivory 8
5 mm



SS-6-5106
Ivory 8
6 mm



SS-6-5107
Ivory 8
7 mm



SS-6-5108
Ivory 8 N



SS-6-5109
Didner 8 P



SS-6-5111



SS-6-5112



SS-6-5113

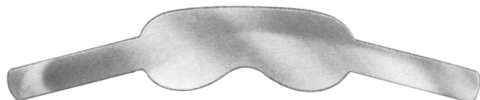

SS-6-5114

1750-5 mm x 100 cm
1750-6 mm x 100 cm
1750-7 mm x 100 cm



SS-6-5110

For Molars and Premolars



SS-6-5115



SS-6-5116



SS-6-5117

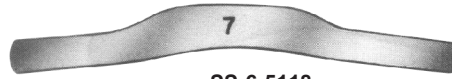

7
SS-6-5118
Molar
Fig 7

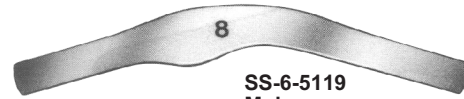

8
SS-6-5119
Molar
Fig 8

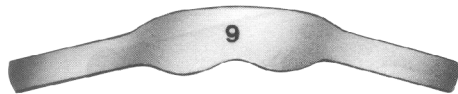

9
SS-6-5120
Molar
Fig 9

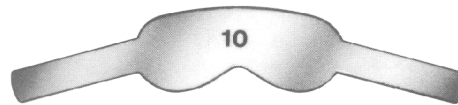

10
SS-6-5121
Molar
Fig 10



1
SS-6-5122
Tofflemire



2
SS-6-5123
Tofflemire



3
SS-6-5124
Tofflemire



11
SS-6-5125
Bicuspid



12
SS-6-5126
Bicuspid



13
SS-6-5127
Bicuspid



1
SS-6-5128
Bicuspid



2
SS-6-5129
Bicuspid



3
SS-6-5130
Bicuspid



SS-6-5134



1
SS-6-5131
Molar



2
SS-6-5132
Molar



3
SS-6-5133
Molars



Page 120-122

- Crown Removers
- Scissors
- Forceps
- Amalgum Guns
- Carries



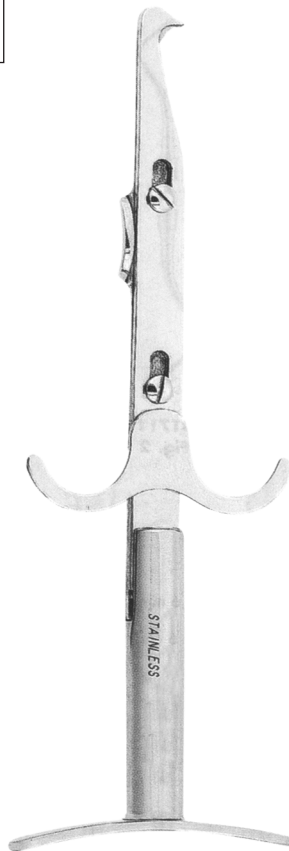
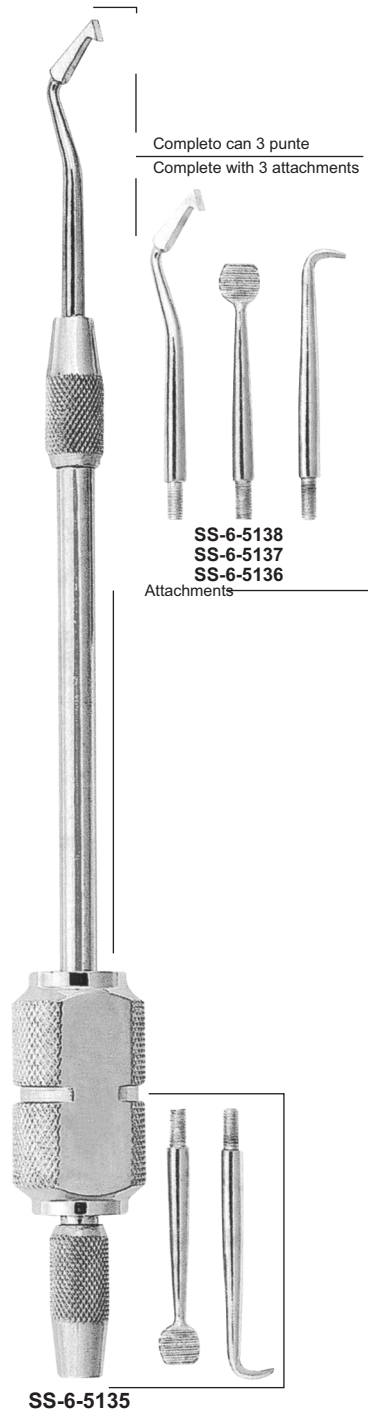

SS-6-5139
Crown Spreader, Crown Remove.
Special instrument for crown spreading
after separating, simple and safe
operation.

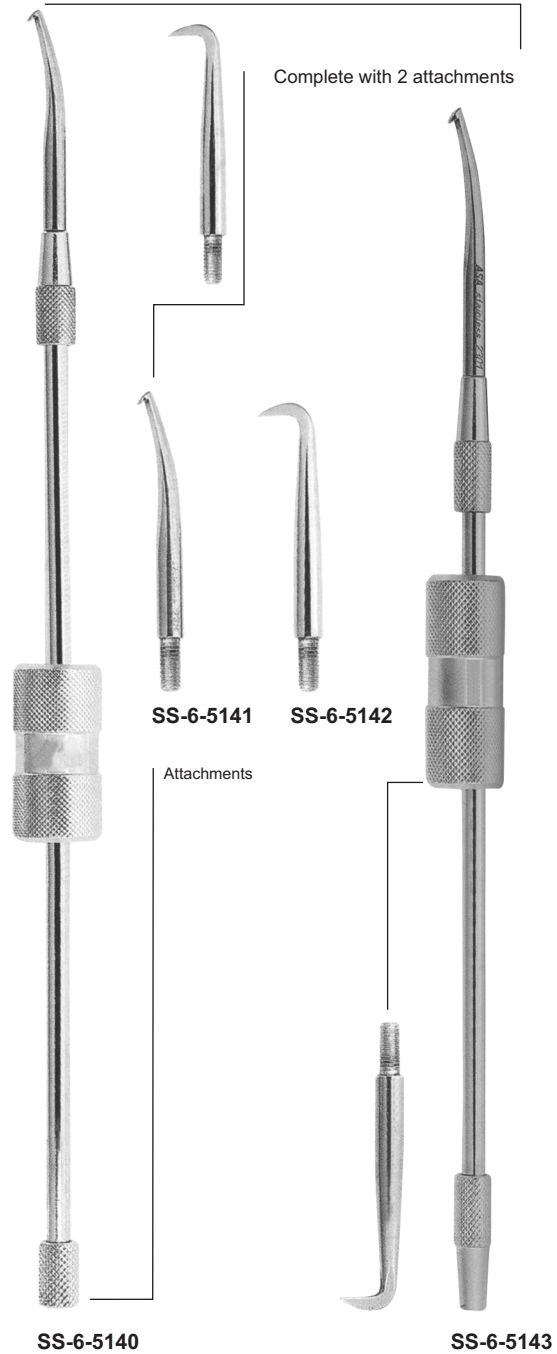



Universal "HM"
12 cm, 4 3/4"

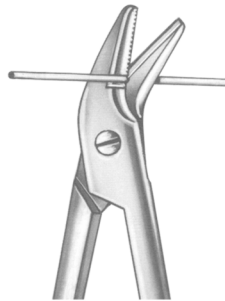

SS-6-5144

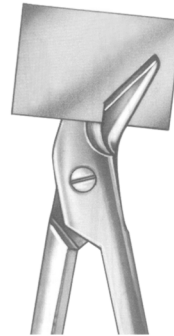

SS-6-5145

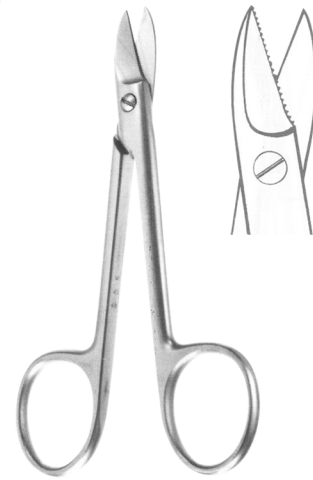

SS-6-5146
Beebee
10,5 cm, 4 1/8"

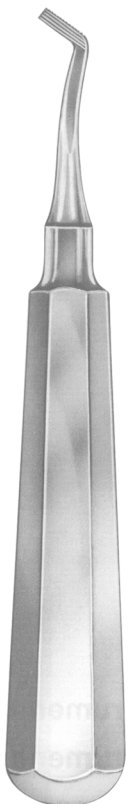

SS-6-5147
Mershon



SS-6-5148
Morell



SS-6-5149
Morell



SS-6-5150
Morell



SS-6-5151
Morell



SS-6-5152
Treymann

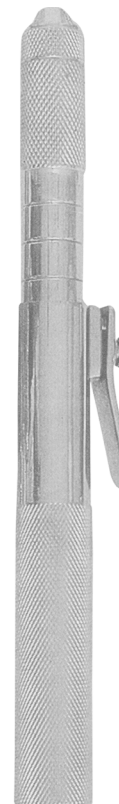

SS-6-5153
Automatic Crown Remover
With 2 Points



SS-6-5154



SS-6-5155

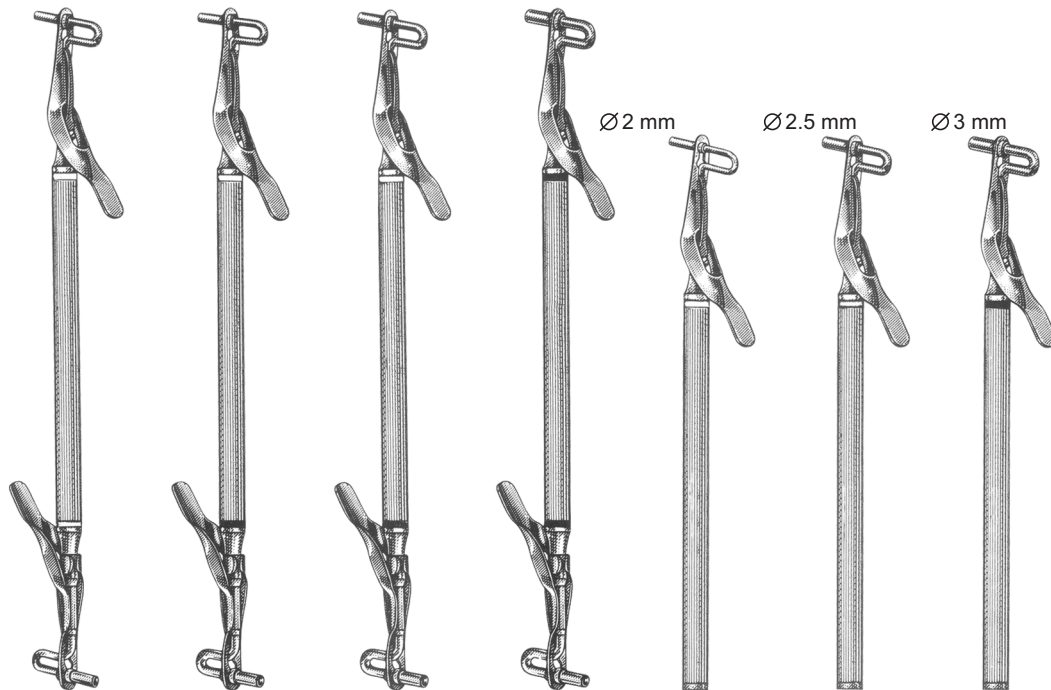

SS-6-5156
Medium-Large
20 cm

SS-6-5157
Medium-Jumbo
20 cm

SS-6-5158
Large-Jumbo
20 cm

SS-6-5159
Jumbo-Jumbo
20 cm

SS-6-5160
Medium
15.5 cm

SS-6-5161
Large
15.5 cm

SS-6-5162
Jumbo
15.5 cm

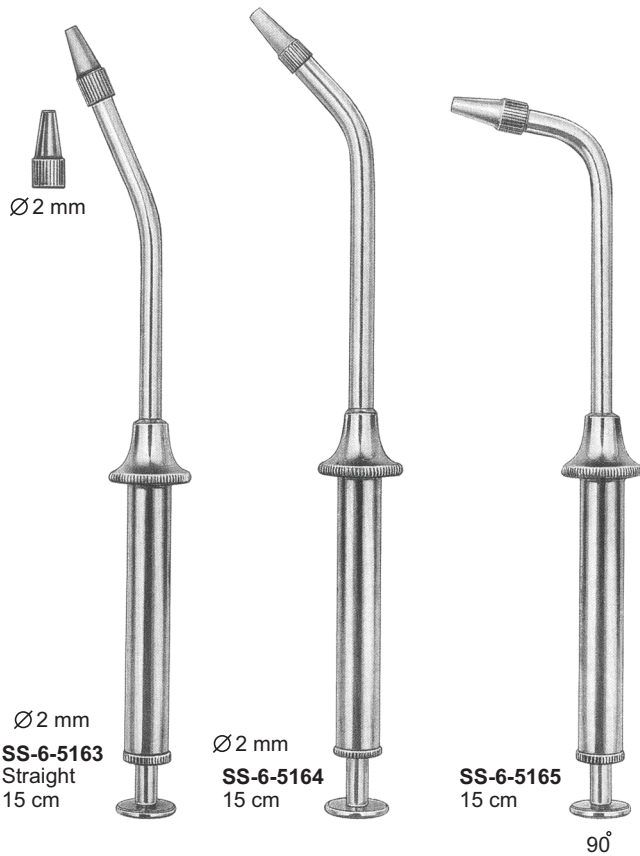

Ø2 mm
SS-6-5163
Straight
15 cm

Ø2 mm
SS-6-5164
15 cm

SS-6-5165
15 cm

90°

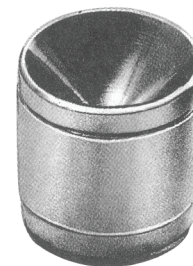

SS-6-5166
Amalgam Well
Non Skid Base
Ø3.5 mm



Page
123

- Copper Ring Removing Plierspaper Articulator Forceps



Copper ring removing pliers



SS-6-5167
Bohm
11,5 cm



SS-6-5168
Bohm
14,5 cm



SS-6-5169
Furrer
16 cm



SS-6-5170
Furrer
16 cm

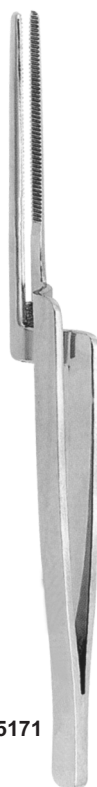

SS-6-5171
Miller
15 cm



SS-6-5172
Miller
15 cm



SS-6-5173
Kelly
14 cm



SS-6-5174
Halstead-Mosquito
12 cm



SS-6-5175
Micro-Mosquito
10 cm



Page
124-127

- Rongeurs



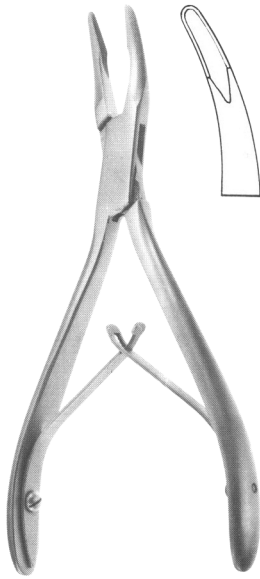

SS-6-5176
Friedmann
14 cm, 5 1/2"

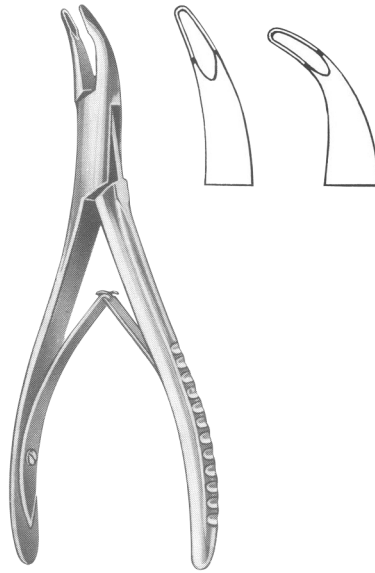

SS-6-5177
14 cm, 5 1/2"

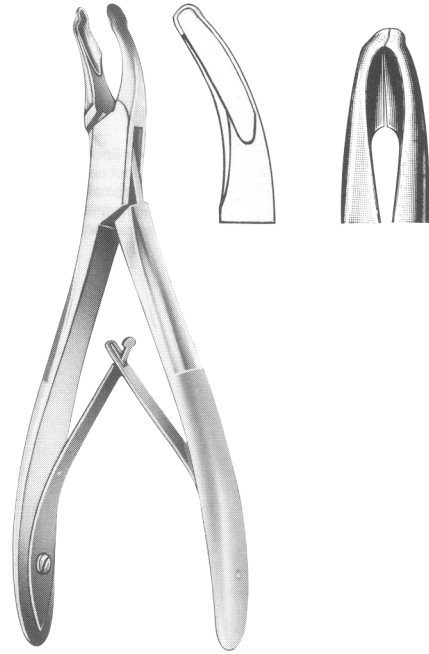

SS-6-5178
Mead
14 cm, 5 1/2"

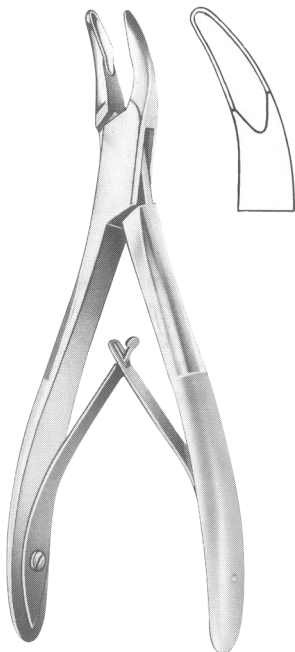

SS-6-5179
Mead
14 cm, 5 1/2"



SS-6-5180
Mead
17 cm, 6 3/4"



SS-6-5181
Schell
17 cm, 6 3/4"

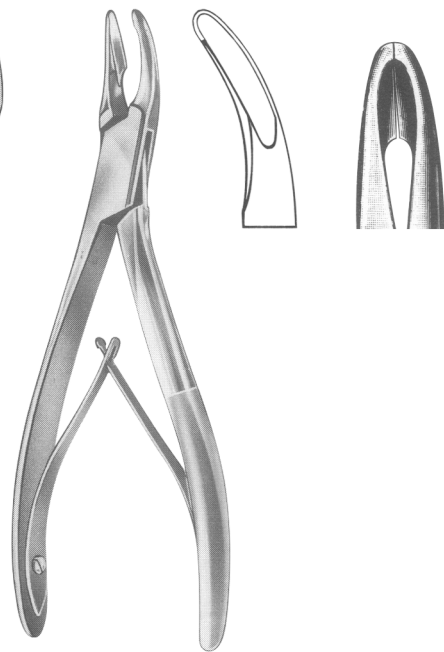



SS-6-5182
Luer
15 cm



SS-6-5183
Friedman
14 cm



SS-6-5184
Mini Friedman
12 cm



SS-6-5185
Goldman-Fax
10 cm



SS-6-5186
Blumenthal
15 cm



SS-6-5187
Blumenthal 45
14,5 cm



SS-6-5188
Blumenthal 90
14 cm



SS-6-5189
Bohler
15 cm



SS-6-5190
Kerrison
15 cm

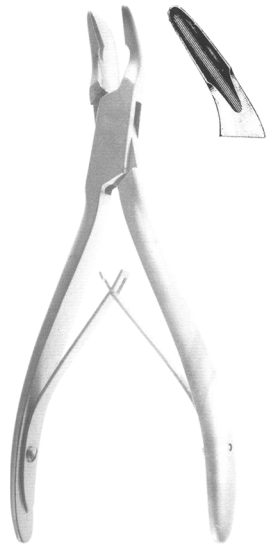

SS-6-5191
Blumenthal
16 cm, 6 1/4"

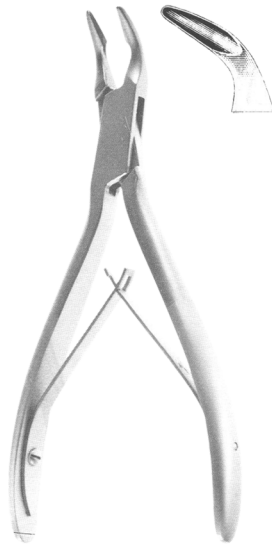

SS-6-5192
Blumenthal
16 cm, 6 1/4"

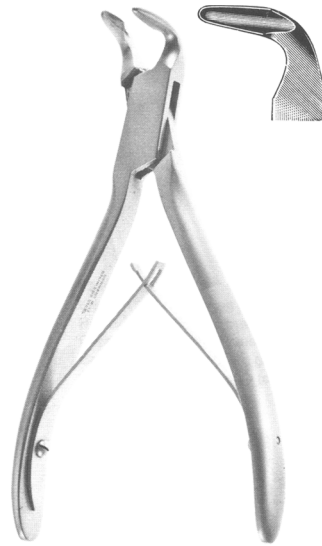

SS-6-5193
Blumenthal
16 cm, 6 1/4"

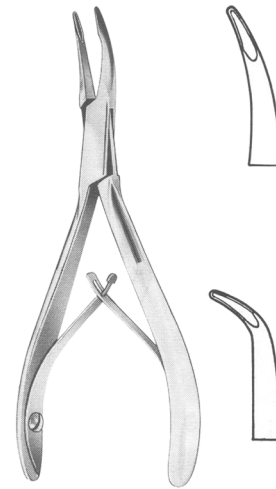

SS-6-5194
Kleinert-Kutz
14 cm, 5 1/2"

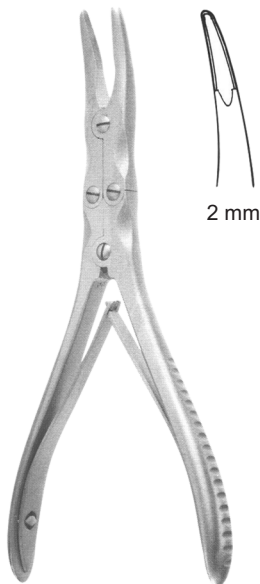

SS-6-5195
Ruskin-Mini
15 cm

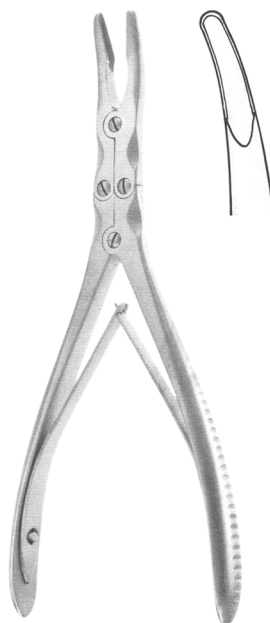
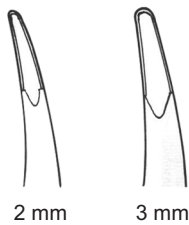

SS-6-5196
Beyer
18 cm, 7 1/8"



SS-6-5197
Zaufal-Jansen
18 cm, 7 1/8"

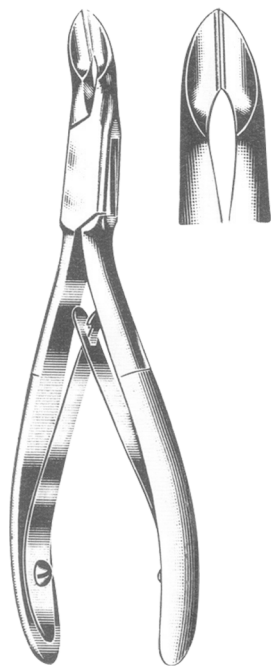

SS-6-5198
Niro
No. 5 S, 14 cm, 5 1/2"

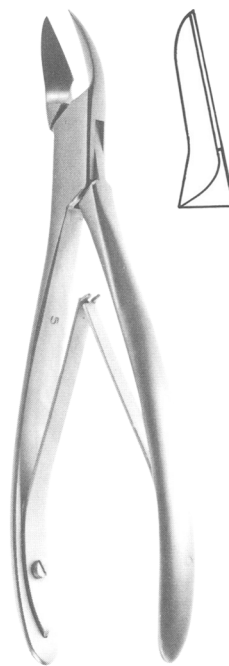

SS-6-5199
Cleveland
No. 5 S, 17 cm, 6 3/4"

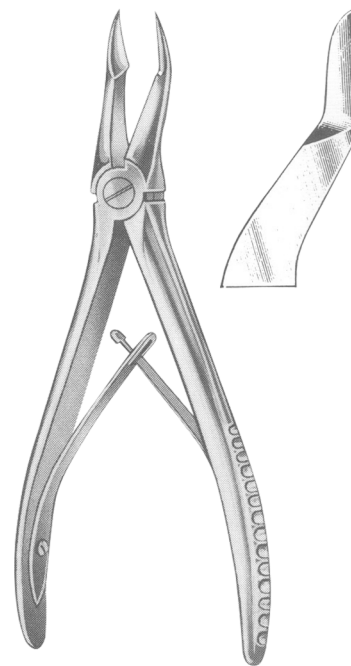

SS-6-5200
No. 18, 15 cm, 6"

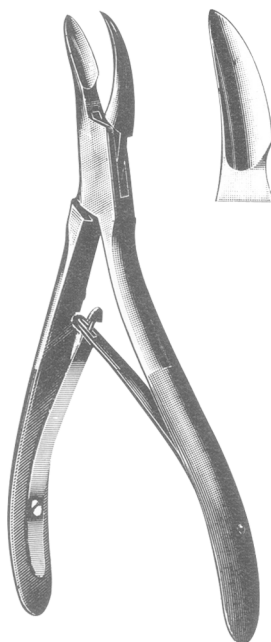

SS-6-5201
Cleveland
16 cm, 6 1/4"



SS-6-5202
Gardner
16 cm, 6 1/4"



SS-6-5203
Liston-mini
15 cm, 6"



Page 128-129

- Bone Elevators, Bone Files and Chisels



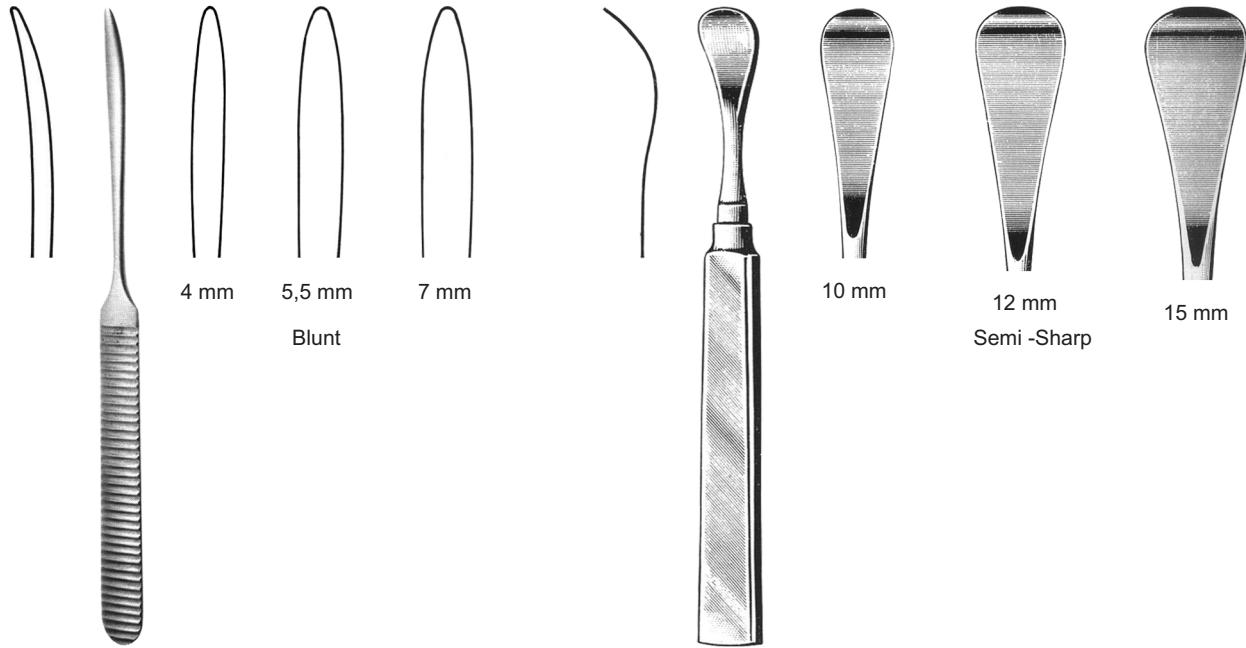

SS-6-5204
Williger
16 cm, 6 1/4"

SS-6-5205
Henahan
17 cm, 6 3/4"

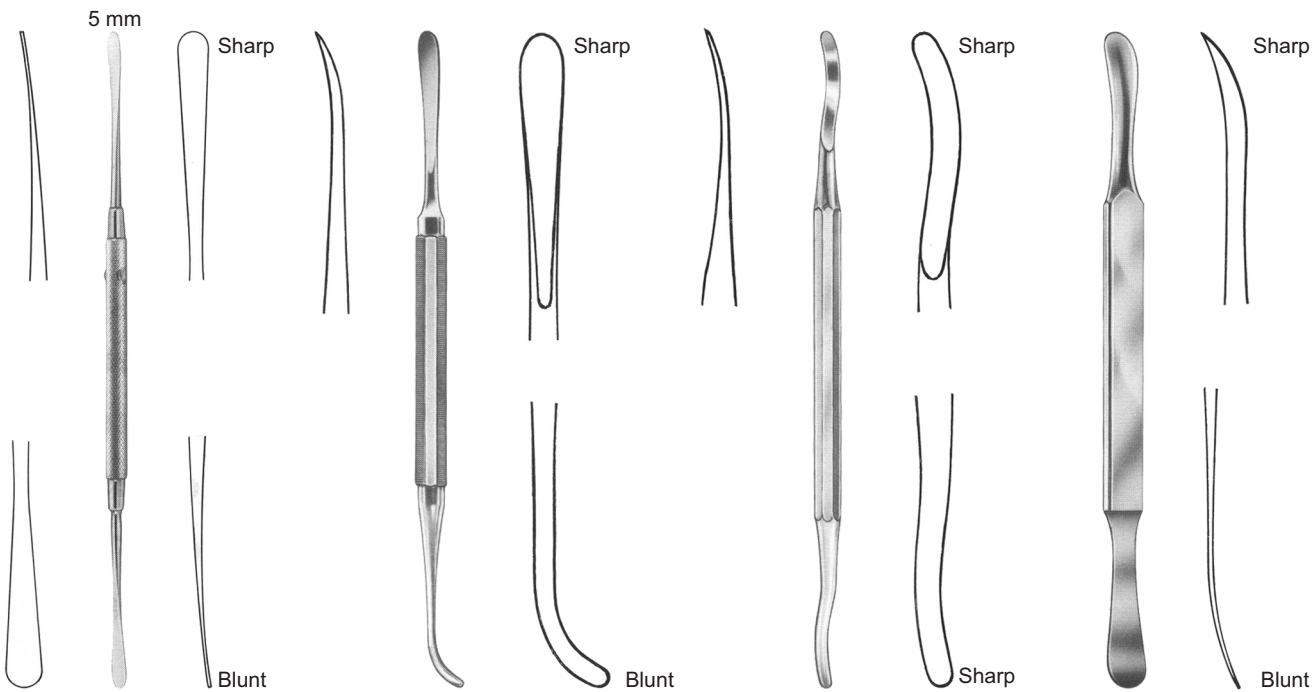

SS-6-5206
Freer
19 cm, 7 1/2"

SS-6-5207
Bennet
17 cm, 6 3/4"

SS-6-5208
Seldin
19 cm, 7 1/2"

SS-6-5209
Seldin
19,5 cm, 7 3/4"

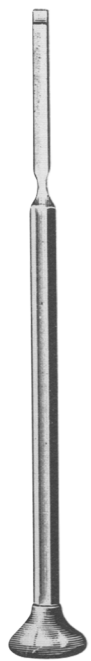

Buckley
15 cm, 6"



SS-6-5210
No. 1
3mm



SS-6-5211
No. 2
4mm



SS-6-5212
No. 3
5mm

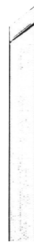

SS-6-5213
No. 4
4mm



SS-6-5214
No. 5
4mm



SS-6-5215 Killian
16 cm, 6 1/4" 5 mm

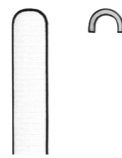

SS-6-5216 Killian-Claus
16 cm, 6 1/4" 5 mm

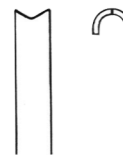

Obwegeser



SS-6-5217
2,5 mm



SS-6-5218
4 mm



SS-6-5219
Miller
No. 10C



SS-6-5220
Miller
No. 11C



SS-6-5221
Miller
No. 12C



SS-6-5222
Miller
No. 13C





Page 130-151

- Pliers For Orthodontics
- Mouth Gags
- Tongue Depressors
- Lip and Cheek Retractors
- Implantology Instrumetns



Pinze per formare loops
Loops forming pliers



SS-7-5101
Adams

Adams pliers for bending
wires up to 0,7mm. (.28").

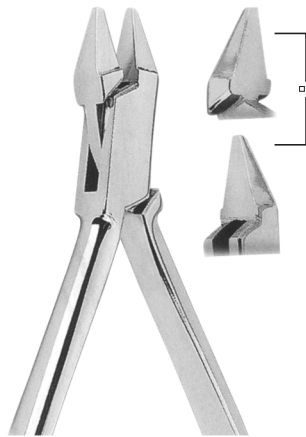

SS-7-5102
Adams

Adams pliers for bending
wires up to 0,7mm. (.28").

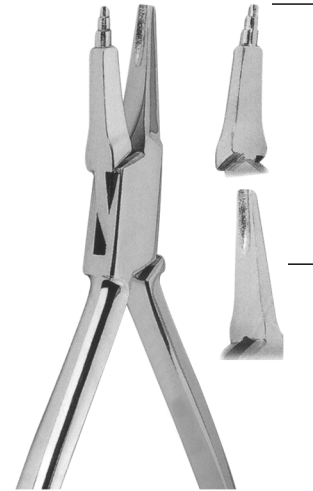

SS-7-5103
Adams

Tweed loop forming pliers.
For forming loop in wires up
to 0,56 mm. (.22").



SS-7-5104
Adams

Aderer three jaws bending
pliers. For wires up
to 0,7 mm. (.28").



SS-7-5105
Adams

Aderer three jaws bending
pliers. For wires upto 0,7 mm.
(.28").

Ligature Cutter Pliers



SS-7-5106

Micro-miniature light wire cutter. It cuts soft ligature wires. For use in caso of limited access. Caution: maximum cutting capacity: soft ligature wire up to 0,30 mm. (.012").



SS-7-5107

Wire cutter. For ligature wires and pins. It is strong enough to bend archwire ends after distal cutting. Maximum cutting capacity up to 0,56 x 0,7 mm. (.022" x .028").

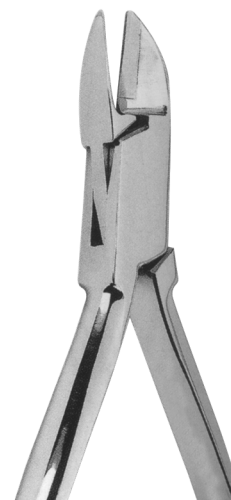

SS-7-5108

Wire cutter. For ligature wires and pins. It is strong enough to bend archwire ends after distal cutting. Maximum cutting capacity: up to 0,9 mm. (.036").



SS-7-5109

Wire cutter. For ligature wires and pins. It is strong enough to bend archwire ends after distal cutting. Maximum cutting capacity: up to 1,5 mm. (.044").

Pinze per formare laboratorio
Laboratory pliers



SS-7-5110

Flat nose pliers with smooth beaks for bending wires up to 0,7 mm. (.028").



SS-7-5111

Bending wires up to 0,7 mm. (.028").



SS-7-5112

Bending wires up to 0,7 mm. (.028").



SS-7-5113

Bending wires up to 0,7 mm. (.028").



SS-7-5114
Nance

Nance loop closing pliers, for bending of stop loops and special for Adams' clasps. Wires up to 0,7 mm. (.028").



SS-7-5115
Nance

Universal pliers for bending wires up to 0,9 mm. (.035") or cutting up to 0,7 mm. (.028").

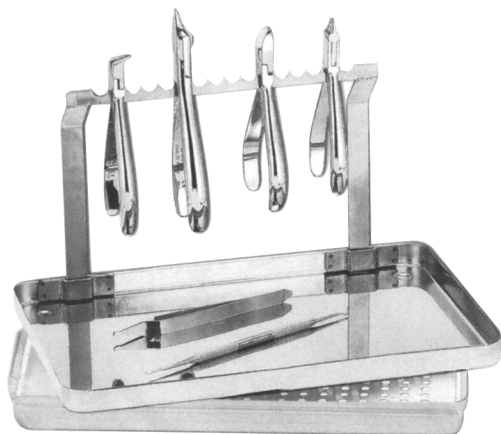

SS-7-5116

Stainless steel pliers tray standard dimensions



SS-7-5117
Universal

Universal pin roughening, cutting and bending pliers. For wires up to 0,9 mm. (.035"). Will cut wires up to 0,7 mm. (.028").

Utility and specialty pliers



SS-7-5118
Reynolds

Reynolds contouring pliers.



SS-7-5119
Reynolds

Lingual arch pliers used to form double and triple back bends in 0,7 mm (.028") or 0,9 mm (.035") wire for insertion in lingual sheaths.



SS-7-5120
Weingart

Weingart pliers with serrated points.

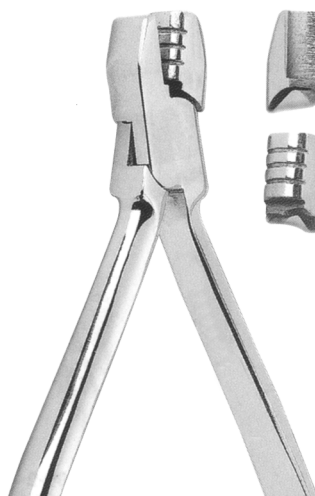

SS-7-5121
De La Rosa

De La Rosa arch forming pliers. Designed to form and contour arch wires on round or rectangular wire. The beak has grooves of 0,4 mm (.016"), 0,46 mm (.018") and 0,56 mm (.022").



SS-7-5122
De La Rosa

Arch forming pliers with a non grooved contouring surface the forming of precise arches.

Loop formare pliers



SS-7-5123
Waldsachs

Waldsachs universal pliers for bending wires up to 1,0 mm. (.039") or cutting up to 0,7 mm. (.028").



SS-7-5124

Round and Concave pliers for loop forming and bending of thin round and square wires up to 0,5 mm. (.020").

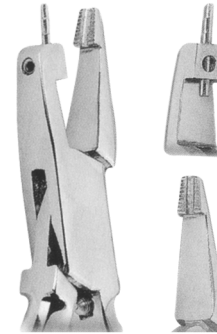

SS-7-5125
Tweed

Tweed loop Forming Pliers. For round or rectangular wires up to 0,56 x 0,7 mm. (.022" x .028"). Replaceable cylindrical beak with three sizes: 1,15 mm. (.045), 1,50 mm. (.059"), 1,90 mm. (.075"). Concave beak with slight parallel serrations, to keep the wire in proper position.

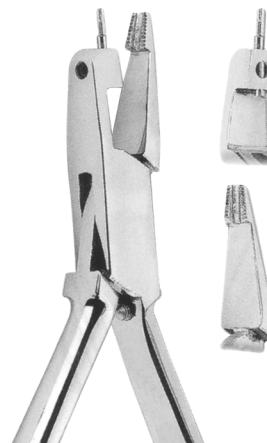

SS-7-5126
Tweed

Tweed Loop Forming Pliers. For making perfect Omega Loops with round or rectangular wires up to 0,56 x 0,7 mm. (.022" x .028"). The concave beak is exactly the same as pliers 5809-1

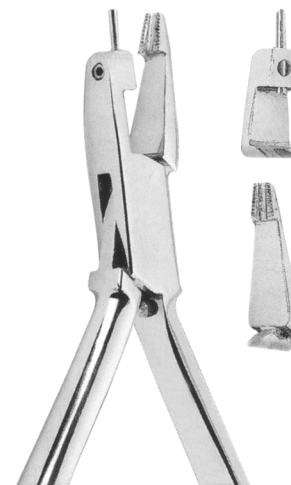

SS-7-5127
Tweed

Single diameter loop forming pliers. Wire up to 0,56 x 0,7 mm. (.022" x 0.28"). Replaceable concave beak has only one diameter section of 1,50 mm. (.059").

Distal end cutters



SS-7-5128

Distal end cutter -safety hold- a precision cutter designed for distal arch cutting in the patient's mouth. It cuts hard wires end holds the loose distal end preventing any damaging of oral tissue. Maximum cutting capacity rectangular wires up to 0,56 x 0,7 mm. (.022" x .020").



SS-7-5129

Micro- distal end cutter - safety hold-. Similar to 3227



SS-7-5130

Direct bonding bracket remover (wide). The removal grip firmly for easy incisal-gingival (vertical) use or, if needed, for mesial-distal (horizontal) use with the same ease.

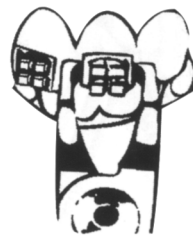

SS-7-5131

Direct bond attachment remover (angled). For removing all bonded attachments. May be used mesial-distal-horizontal) or incisal-gingival (vertical) in anterior areas. Angled perfectly for easy access to difficult posterior areas.

Bird beak pliers



SS-7-5132
Wire bending pliers. For wires up to 0,9 mm. (.036").

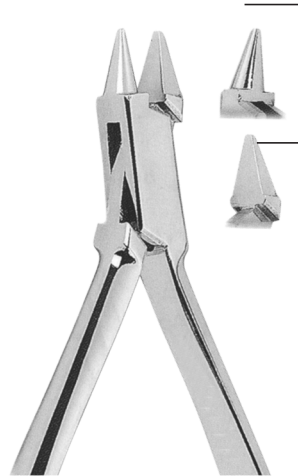

SS-7-5133
Bird Beak Angle pliers for bending round, square or rectangular wire up to 0,7 mm. (.028").



SS-7-5134
Double rounded jaw wire bending pliers. For wires up to 0,7 mm. (.028").



SS-7-5135
Bird beak pliers for bending round, square or rectangular wire up to 0,7 mm. (.028"). With cutter.

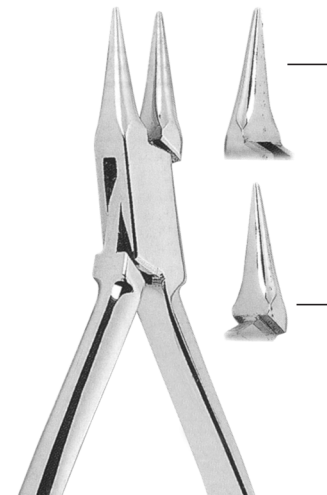

SS-7-5136
Double rounded jaw wire bending pliers. For wires up to 0,7 mm. (.028").



SS-7-5137
USA Model
125 mm



SS-7-5138
Waldron
125 mm



SS-7-5139
How
140 mm



SS-7-5140
How
145 mm

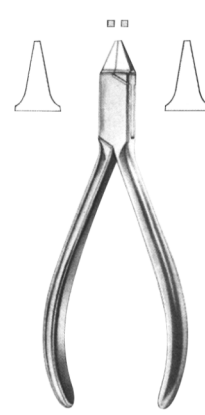

SS-7-5141
Adams
125 mm



SS-7-5142
Angle
125 mm



SS-7-5143
young
130 mm



SS-7-5144
Nance
130 mm



SS-7-5145
Weingart
140 mm



SS-7-5146
Johnson
130 mm



SS-7-5147
Mc Kellops
155 mm

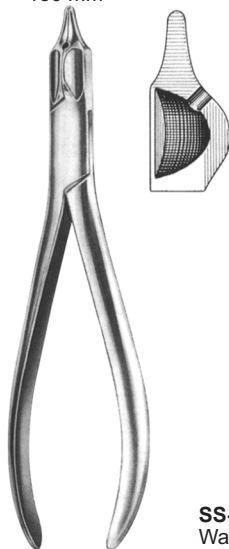

SS-7-5148
Universal
150 mm

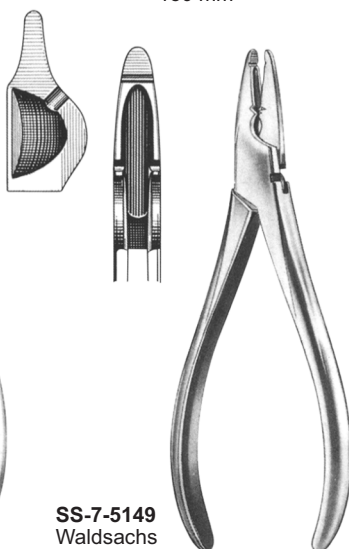

SS-7-5149
Waldsachs
155 mm

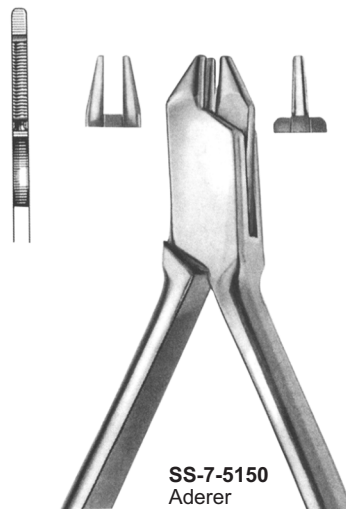

SS-7-5150
Aderer
125 mm



SS-7-5151
Nance
130 mm



SS-7-5152
Langenbeck
140 mm



SS-7-5153
Langenbeck
130 mm



SS-7-5154
Langenbeck
130 mm



SS-7-5155
Peeso
125 mm



SS-7-5156
Goslee
125 mm

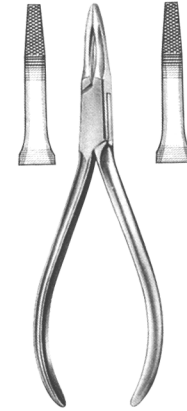

SS-7-5157
Fischer
140 mm

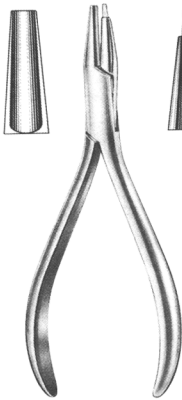

SS-7-5158
Andresen
130 mm

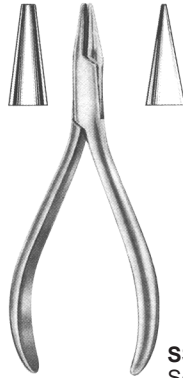

SS-7-5159
Schwarz
130 mm

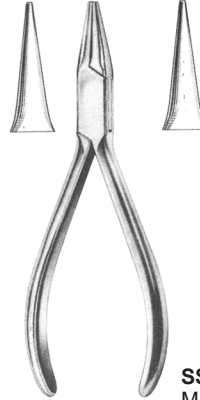

SS-7-5160
MSY
130 mm

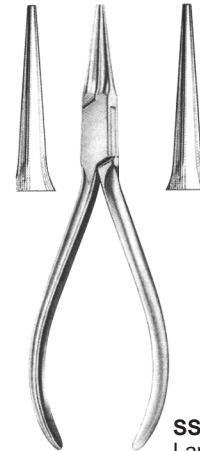

SS-7-5161
Langenbeck
125 mm



SS-7-5162

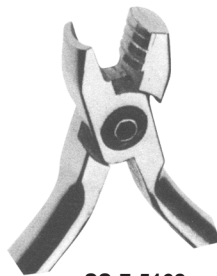

SS-7-5163



SS-7-5164



SS-7-5165



SS-7-5166

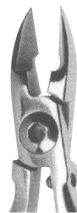

SS-7-5167



SS-7-5168



SS-7-5169

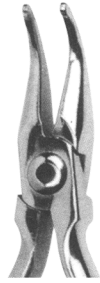

SS-7-5170

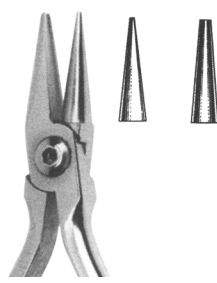

SS-7-5171

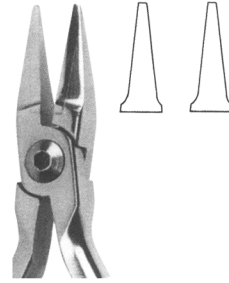

SS-7-5172

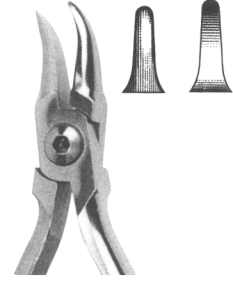

SS-7-5173

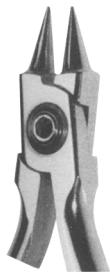

SS-7-5174

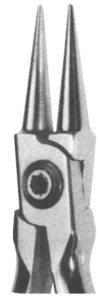

SS-7-5175

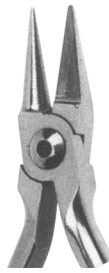

SS-7-5176

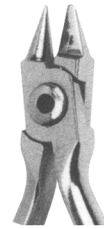

SS-7-5177



SS-7-5178

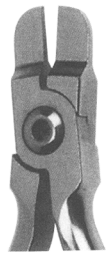

SS-7-5179

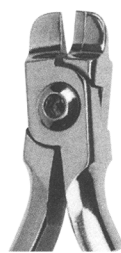

SS-7-5180

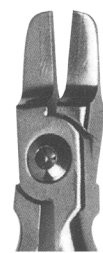

SS-7-5181

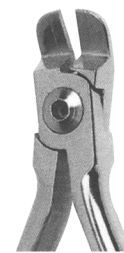

SS-7-5182

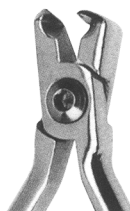

SS-7-5183

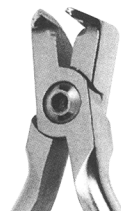

SS-7-5184

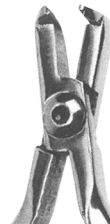

SS-7-5185

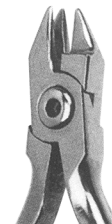

SS-7-5186



Molt
SS-7-5187 10 cm
SS-7-5188 11 cm
SS-7-5189 14 cm



SS-7-5190 16 cm
SS-7-5191 19 cm
 Roser-König

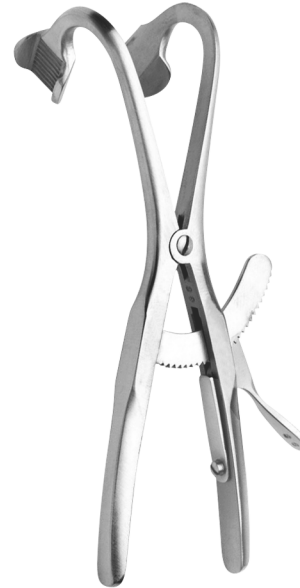

SS-7-5192
 Denhardt
 13 cm



SS-7-5193
 Fergusson - Ackland
 14.5 cm



SS-7-5194
 Heister
 Maunder Wood
 9.5 cm



SS-7-5195
 Obwegeser 11 cm
 Spreading 47 mm



SS-7-5196
 Heister
 13 cm



SS-7-5197 Small
SS-7-5198 Medium
SS-7-5199 Large
 Cheek Retractor

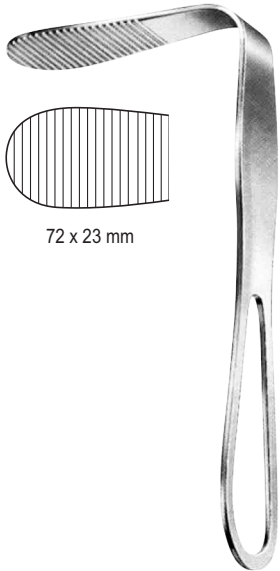

72 x 23 mm

SS-7-5200
Hartmann
15 cm



SS-7-5201
Doyen Tongue Spatula
13.5 cm



SS-7-5202
14.5 cm



SS-7-5203
18 cm



SS-7-5204
Bruenings
19 cm

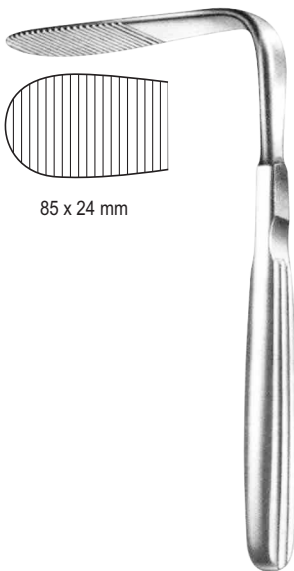

85 x 24 mm

SS-7-5205
Tobold
15 cm

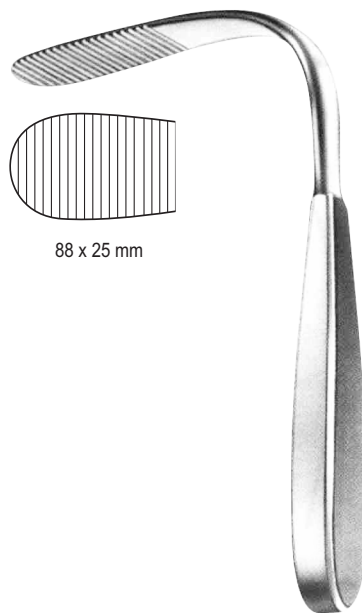

88 x 25 mm

SS-7-5206
Tobold
16 cm

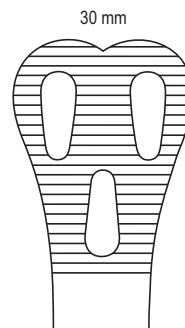

SS-7-5207
14 cm

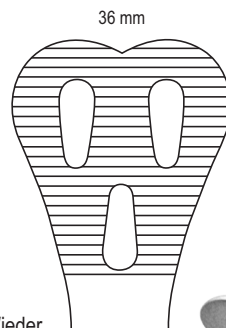

SS-7-5208
15 cm

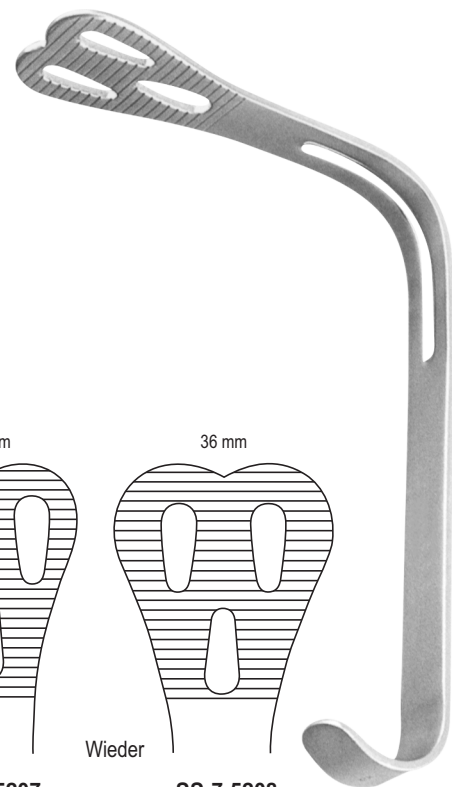

Wieder

30 mm

36 mm

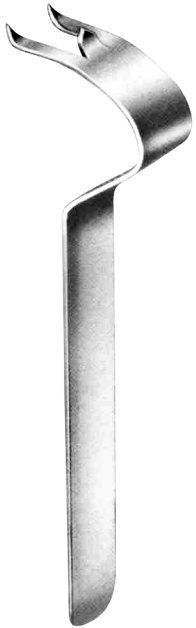

SS-7-5209
Obwegeser Chin
Retractor
16.5 cm



Obwegeser 16 cm
SS-7-5210 8 mm
SS-7-5211 10 mm



SS-7-5212 43 x 11 mm
SS-7-5213 57 x 11 mm
SS-7-5214 83 x 16 mm

35 x 11 mm



SS-7-521
5
Obwegeser
ramus retractor
22 cm



72 x 11 mm

SS-7-5216
Obwegeser
Ramus retractor for
separation of ramus & tissue
22 cm



SS-7-5217
Simplex
10.5 cm



30x19 mm

33x25 mm

SS-7-5218
Kilner
15 cm



SS-7-5219
Minnesota
14 cm



SS-7-5220
Cawood-Minnesota
15 cm



SS-7-5221
Austin



SS-7-5222
Hilger
Fits any simple stem mouth mirror handle

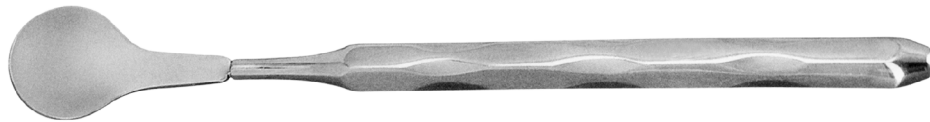

SS-7-5223
Hilger
with handle

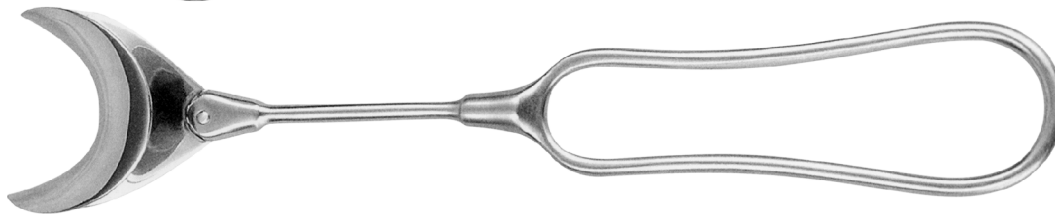

SS-7-5224
Max
20 cm

Finger protectors



Langenbeck

SS-7-5225 Small
SS-7-5226 Medium
SS-7-5227 Large

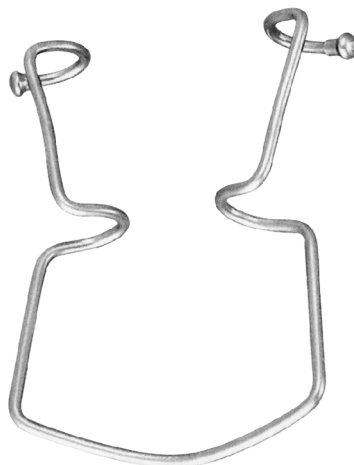

SS-7-5228
Oringer
11.5 cm

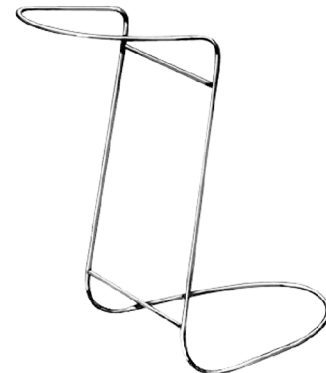

SS-7-5229
Obwegeser Cheek Retractor
12cm



SS-7-5230
Columbia
14.5 cm



Sternberg

SS-7-5231 12 cm
SS-7-5232 14 cm
SS-7-5233 15 cm



Vestibulum
SS-7-5234



SS-7-5235
Max

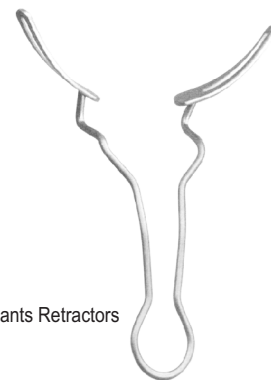

Implants Retractors

SS-7-5236
Max

Retractors

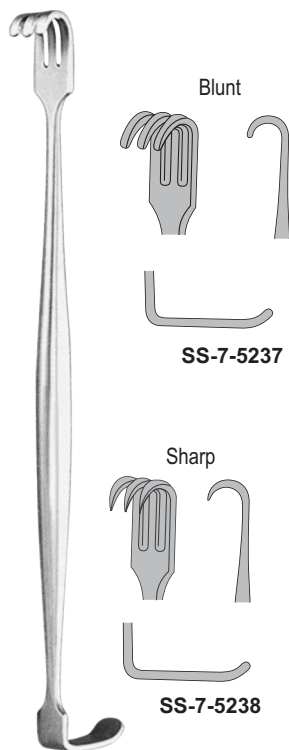

Blunt

SS-7-5237

Sharp

SS-7-5238

Senn-Miller
16 cm



Sharp

SS-7-5239

SS-7-5240

SS-7-5241

SS-7-5242

Max
16 cm



Blunt

SS-7-5243

SS-7-5244

SS-7-5245

SS-7-5246

Max
16 cm

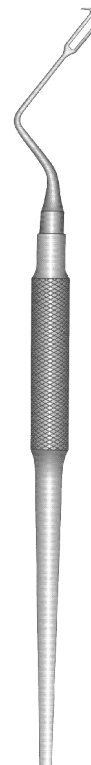

Kirkland
Gum & Tissue
Retractors



SS-7-5247
Fig. 23 K



SS-7-5248
Fig. 24 K

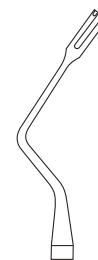

SS-7-5249
Fig. 27 K



SS-7-5250
Fig. 28 K



SS-7-5251
Collin Tongue holding forceps
17 cm



SS-7-5254
Rubber Pad pair

Young Tongue holding forceps
SS-7-5252 15 cm
SS-7-5253 17 cm



SS-7-5255
Farabeuf 12 cm
Pair



SS-7-5256
Parker-Langenbeck 21 cm
Pair

Osteotomes



15.5 cm

# 1	Diam.
0	Ø 1.60
7.5	Ø 1.80
10	Ø 2.00
13.5	Ø 2.40
15.5	Ø 3.60

1
Ø 1.6 mm



SS-7-5257
15.5 cm

# 2	Diam.
0	Ø 1.90
7.5	Ø 2.20
10	Ø 2.35
13.5	Ø 3.30
15.5	Ø 3.40
23.5	Ø 4.50

2
Ø 1.9 mm



SS-7-5258
15.5 cm

# 3	Diam.
0	Ø 2.80
7.5	Ø 3.20
10.5	Ø 3.35
13.5	Ø 3.60
21	Ø 4.40

3
Ø 2.8 mm



SS-7-5259
15.5 cm

# 4	Diam.
0	Ø 3.10
7.5	Ø 3.70
10.5	Ø 3.90
15.5	Ø 4.30

4
Ø 3.10 mm



SS-7-5260
15.5 cm

# 5	Diam.
0	Ø 3.90
10	Ø 5.00
13	Ø 5.20
20.5	Ø 6.30

5
Ø 3.90 mm



SS-7-5261
15.5 cm

# 6	Diam.
0	Ø 5.50
10	Ø 6.20
13	Ø 6.30

6
Ø 5.50 mm



SS-7-5262
15.5 cm

# 1	Diam.
0	Ø 1.50
5	Ø 1.90
8	Ø 2.20
10	Ø 2.40
12	Ø 2.60
14	Ø 2.80

1
Ø 1.5 mm



SS-7-5263
15.5 cm

# 2	Diam.
0	Ø 2.10
5	Ø 2.60
8	Ø 2.80
10	Ø 3.00
12	Ø 3.20
14	Ø 3.40

2
Ø 2.1 mm



SS-7-5264
15.5 cm

# 3	Diam.
0	Ø 2.60
5	Ø 3.00
8	Ø 3.30
10	Ø 3.50
12	Ø 3.70
14	Ø 3.90

3
Ø 2.6 mm



SS-7-5265
15.5 cm

# 4	Diam.
0	Ø 3.00
5	Ø 3.50
8	Ø 3.80
10	Ø 4.00
12	Ø 4.20
14	Ø 4.40

4
Ø 3.0 mm



SS-7-5266
15.5 cm

# 5	Diam.
0	Ø 3.50
5	Ø 3.90
8	Ø 4.20
10	Ø 4.40
12	Ø 4.60
14	Ø 4.80

5
Ø 3.5 mm



SS-7-5267
15.5 cm

Ø 2.8 mm



SS-7-5268
15.5 cm

Ø 3.5 mm



SS-7-5269
15.5 cm

Ø 4.2 mm



SS-7-5270
15.5 cm

Spelling Straight
Bone Pusher

Osteotomes

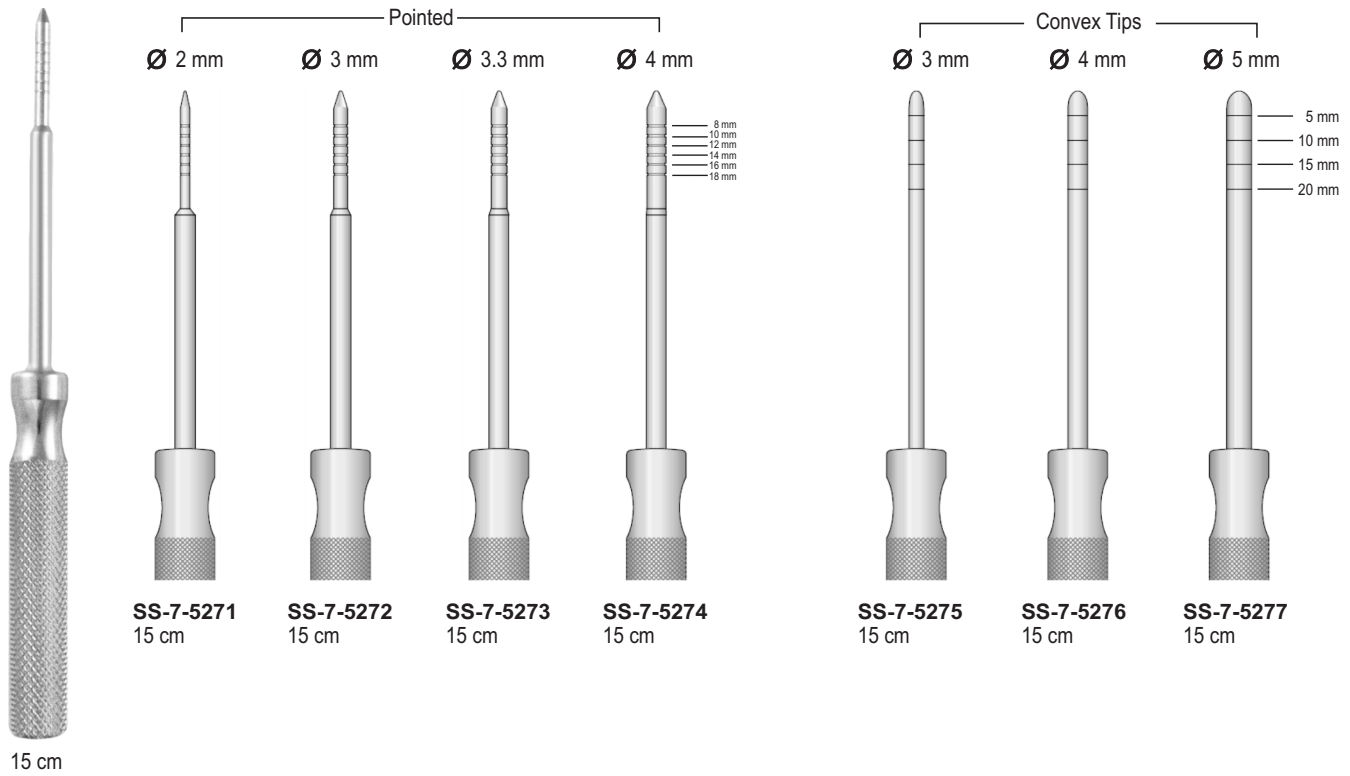

Convex Tips

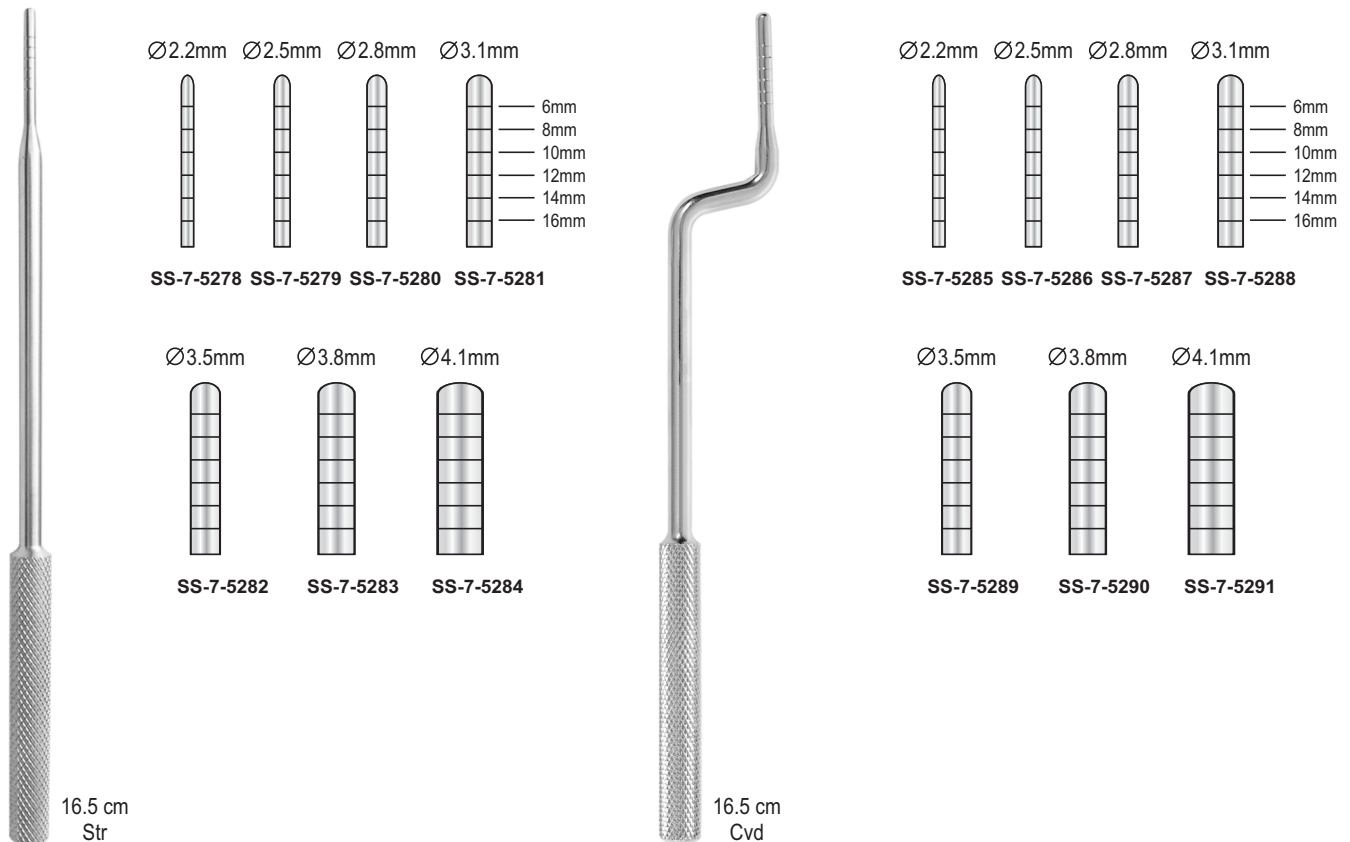

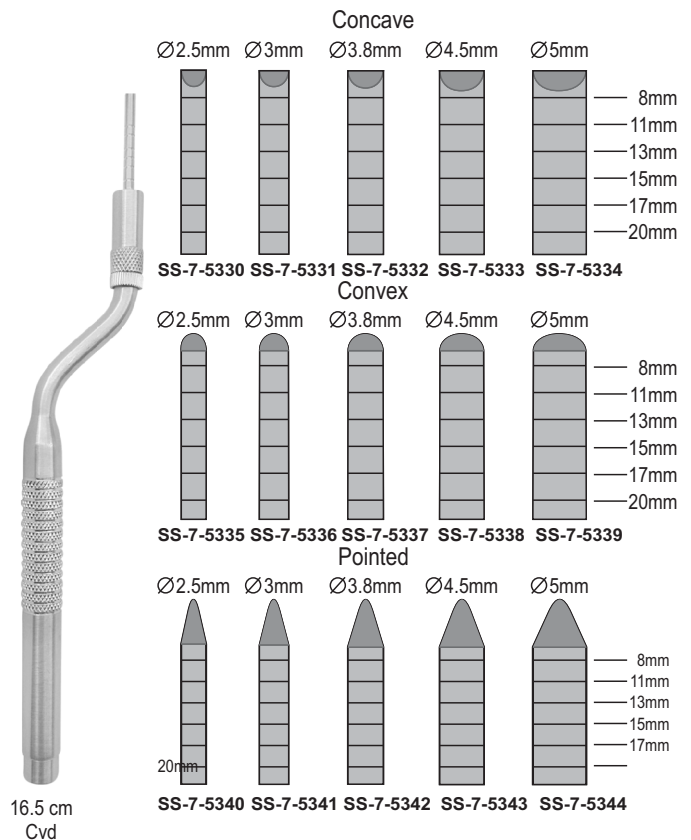
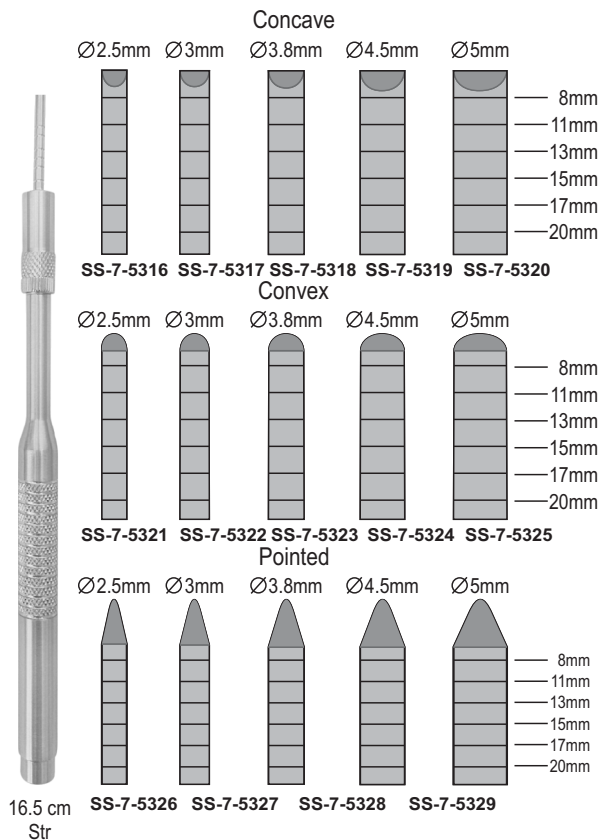
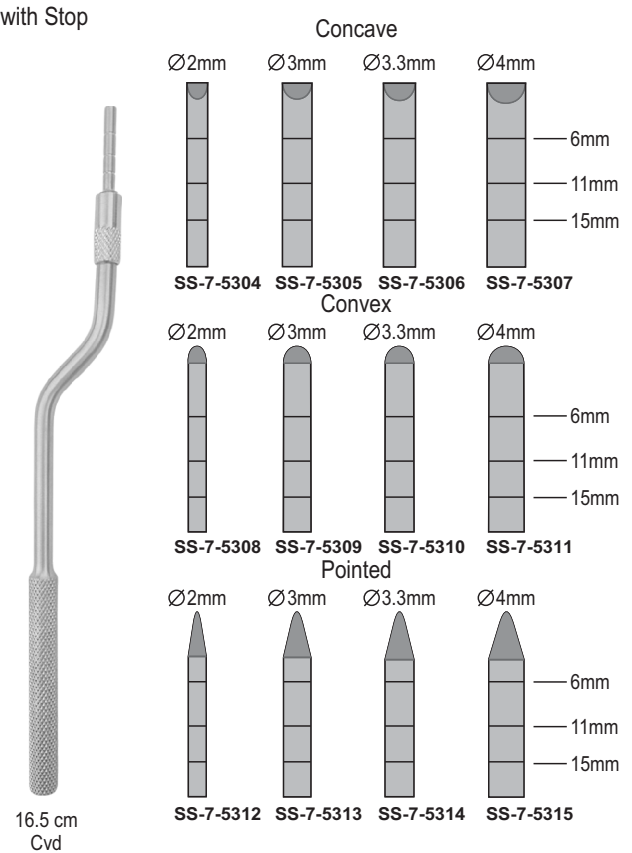
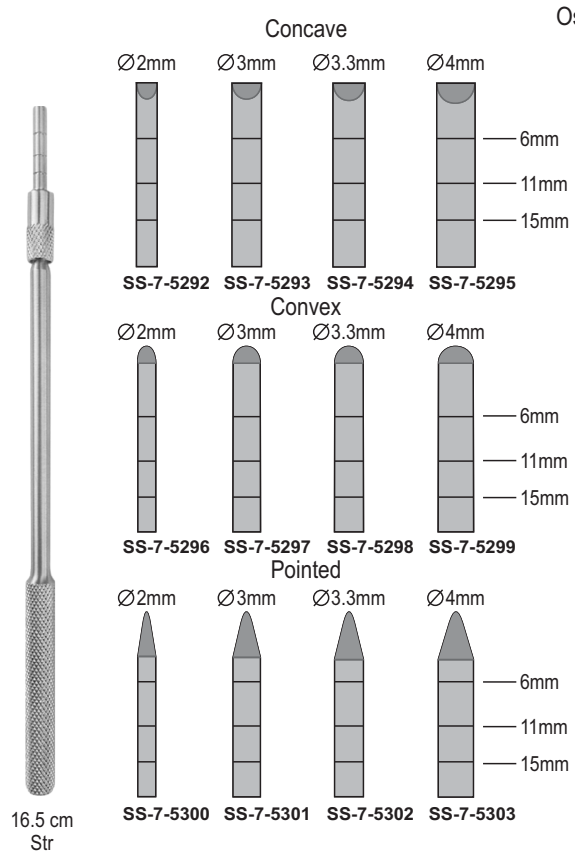

PDL Elevators



SS-7-5345 Distal, 2.5 mm Micro Edge

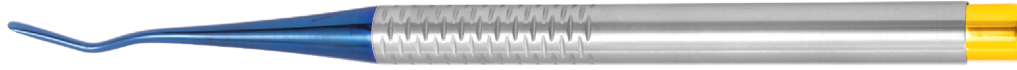

SS-7-5346 Mesial, 2.5 mm Micro Edge

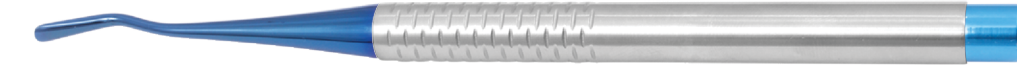

SS-7-5347 Distal, 4 mm Micro Edge



SS-7-5348 Mesial 4 mm Micro Edge

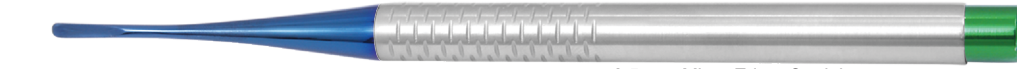

SS-7-5349 2.5 mm Micro Edge, Straight



SS-7-5350 2.5 mm Micro Edge, Curved



SS-7-5351 3.4 mm

Straight **SS-7-5352** Set

Of 7 Pieces



SS-7-5353 Distal, 2.5 mm Micro Edge

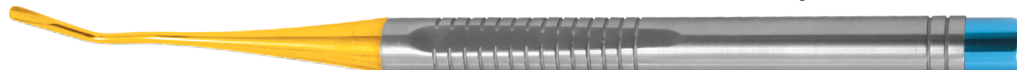

SS-7-5354 Mesial, 2.5 mm Micro Edge



SS-7-5355 Distal, 4 mm Micro Edge



SS-7-5356 Mesial 4 mm Micro Edge



SS-7-5357 2.5 mm Micro Edge, Straight

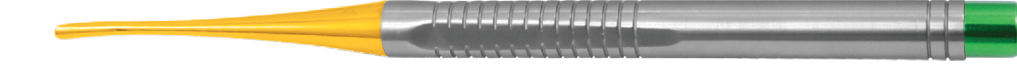

SS-7-5358 2.5 mm Micro Edge, Curved



SS-7-5359 3.4 mm Straight

SS-7-5360 Set Of 7 Pieces



Instruments Tray

Trepine Drills



SS-7-5361
Interior 2 mm
Exterior 3 mm



SS-7-5362
Interior 3 mm
Exterior 4 mm



SS-7-5363
Interior 4 mm
Exterior 5 mm



SS-7-5364
Interior 5 mm
Exterior 6 mm



SS-7-5365
Interior 6 mm
Exterior 7 mm



SS-7-5366
Interior 7 mm
Exterior 8 mm



SS-7-5367
Interior 8 mm
Exterior 9 mm



SS-7-5368
Interior 9 mm
Exterior 10 mm



SS-7-5369
Trepine Drills Stand
Complete with drills



SS-7-5370
Trepine Drills Stand
Complete with drills

Tissue Punches



SS-7-5371
2 mm

SS-7-5372
3 mm

SS-7-5373
4 mm

SS-7-5374
5 mm

SS-7-5375
6 mm

SS-7-5376
7 mm

SS-7-5377
8 mm



SS-7-5378
3 mm

SS-7-5379
4 mm

SS-7-5380
5 mm

SS-7-5381
6 mm

Keyes

Keyes



SS-7-5382
Bone Collector Chisel Straight



SS-7-5383
Blade for Straight bone collector chisel



SS-7-5384
Bone Collector Chisel Curved



SS-7-5385
Blade for Curved bone collector chisel



SS-7-5386
Ratchet Screw driver handle
Hexagonal head

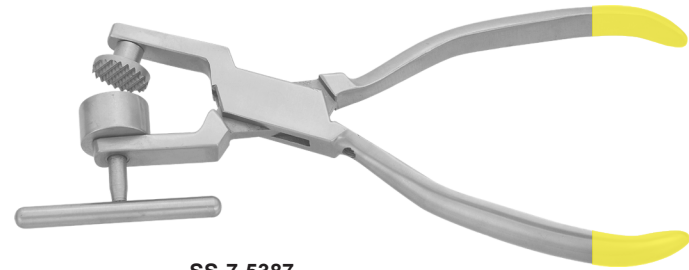

SS-7-5387
Bone Morselizer with Titanium Grinding



SS-7-5388
Bone Mixing Basin
Dia 35 mm



SS-7-5389
Manual Easy Bone Mill



SS-7-5390
Bone Craker Titanium



Page
152-155

- Impression Trays



All Impression Trays Upper & Lower Type
are available in S, M, L & XL Sizes



SS-7-5391
"HYDRO-LOCK"
stainless steel
water-cooled
impression trays
with retention rim.



SS-7-5392
"HYDRO-LOCK"
stainless steel
water-cooled impression
trays with retention rim.



SS-7-5393
"NEW SUPER"
stainless steel
impression trays
with retention rim.



SS-7-5394
"NEW SUPER" stainless
steel impression trays
with retention rim.



SS-7-5395
"ANATOMIC" solid
regular stainless
steel impression
trays without
retention rim.



SS-7-5396
"ANATOMIC" solid regular
stainless steel impression
trays without retention rim.



SS-7-5397
Perforated-total denture
stainless steel
impression trays with rim.



SS-7-5398
Perforated-total denture
stainless steel
impression trays with rim.

All Impression Trays Upper & Lower Type are available in S, M, L & XL Sizes



SS-7-5399
"PERMA-LOCK" solid regular stainless steel impression trays with retention rim.



SS-7-5400
"PERMA-LOCK" solid regular stainless steel impression trays with retention rim.



SS-7-5401



SS-7-5402



SS-7-5403



SS-7-5404



SS-7-5405



SS-7-5406



SS-7-5407
Set of six

PACKINGS



SS-7-5408
Set of Eight



SS-7-5409
Solid stainless steel anterior depressed impression trays with retention rim.



SS-7-5410



SS-7-5411



SS-7-5412



SS-7-5413



SS-7-5414



SS-7-5415



SS-7-5416
Solid stainless steel anterior depressed impression trays with retention rim.

All Impression Trays Upper & Lower Type
are available in S, M, L & XL Sizes



SS-7-5417
Fig. 0 per bambini - for children

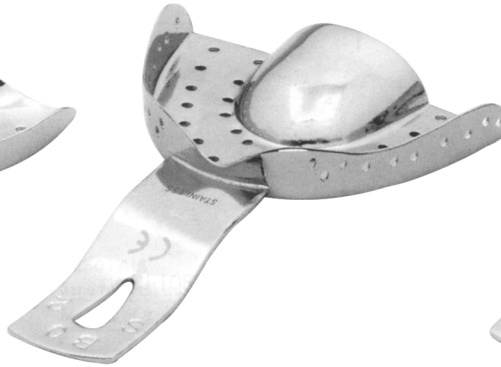

SS-7-5418
For narrow toothed upper jaws



SS-7-5419
Fig. 0 per bambini - for children



SS-7-5420
For partially toothed upper jaws



SS-7-5421
For partially toothed lower jaws



SS-7-5422
For edentulous upper jaws



SS-7-5423
For edentulous lower jaws

All Impression Trays Upper & Lower Type are available in S, M, L & XL Sizes



SS-7-5424
Solid total denture stainless steel impression tray with rim.



SS-7-5425
Solid total denture stainless steel impression tray with rim.



SS-7-5426
"PERMA-LOCK" perforated regular stainless steel impression trays with retention rim.



SS-7-5427
"PERMA-LOCK" perforated regular stainless steel impression trays with retention rim.



SS-7-5428
Perforated stainless steel anterior depressed impression trays with retention rim.



SS-7-5429



SS-7-5430



SS-7-5431



SS-7-5432



SS-7-5433



SS-7-5434



SS-7-5435
Perforated stainless steel anterior depressed impression trays with retention rim.



SS-7-5436
Perforated stainless steel impression trays without retention rim for complete denture.



SS-7-5437
Perforated stainless steel impression trays without retention rim for complete denture.



Page
156-157

- Arricators



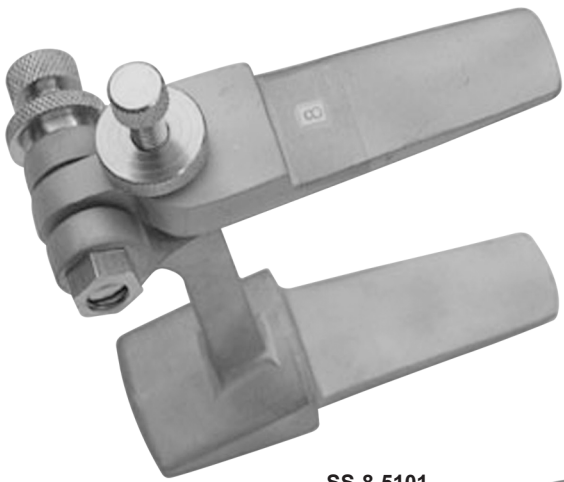

SS-8-5101



SS-8-5102



SS-8-5103



SS-8-5104

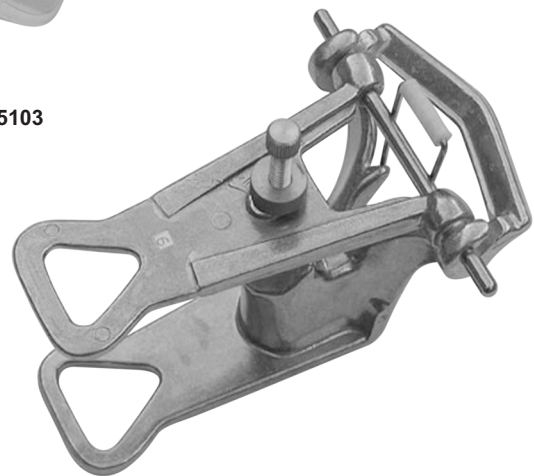

SS-8-5105



SS-8-5106

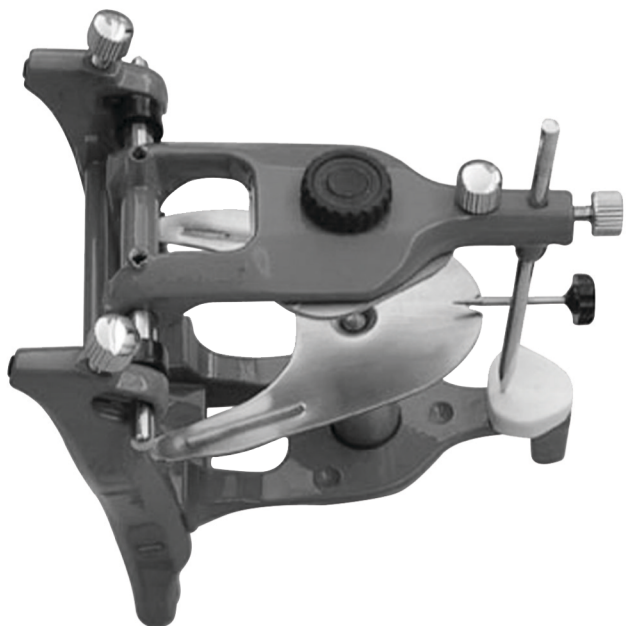

SS-8-5107



SS-8-5108



SS-8-5109



SS-8-5110



Page
158-160

- Dental Surgical Hollowares



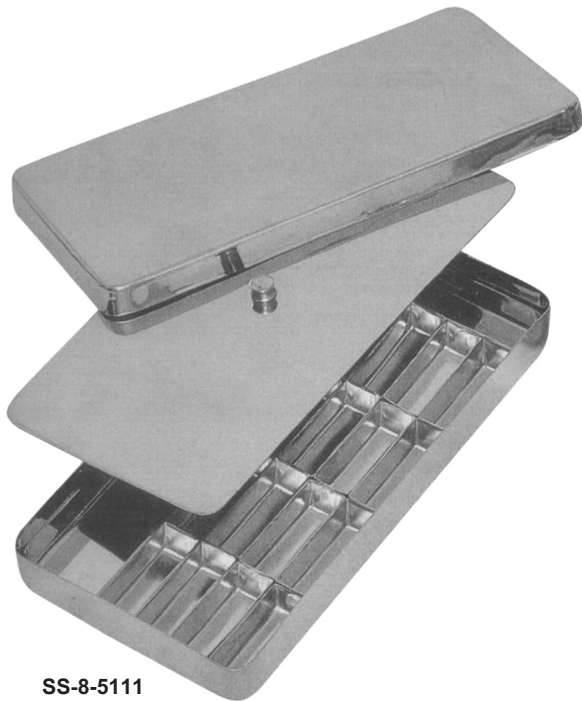

SS-8-5111
ENDODONTICBOX



SS-8-5112
STERILIZINGBOX
Available in dif. sizes
17x17x3 cm
20x10x4 cm
25x12x6 cm
30x14x6 cm



SS-8-5113 ENDO
TRAY BOX

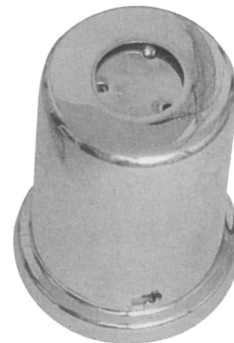

SS-8-5114
COTTONDISPENSER

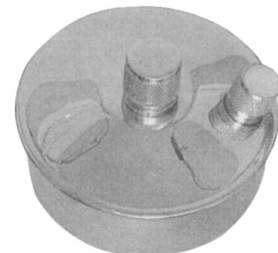

SS-8-5115
ALCOHOLLAMP

Sterilizing Drums



SS-8-5116



SS-8-5117

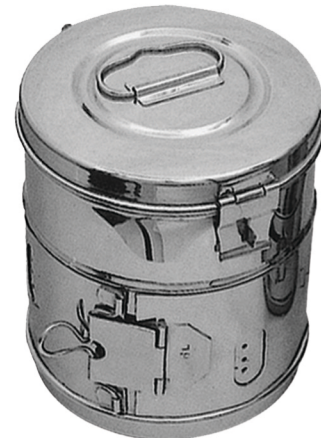

SS-8-5118

Sterilizing Boxes



SS-8-5119



SS-8-5120



SS-8-5121

Sterilizing Boxes



SS-8-5122



SS-8-5123



SS-8-5124



SS-8-5125

FORCEP AND THERMOMETER JARS



SS-8-5126



SS-8-5127

COTTON DISPENSER



SS-8-5128
IRRIGATOR(Douchcan)



SS-8-5129
MEASURINGJUG

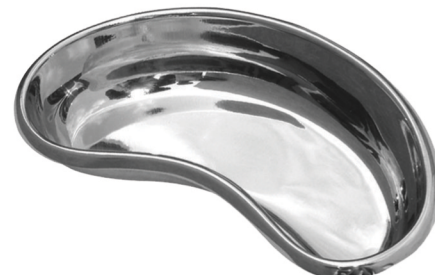

SS-8-5130
KIDNEY TRAY



SS-8-5131
FORCEP JAR

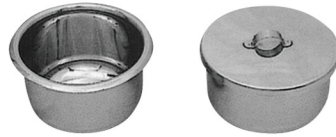

SS-8-5132
GALLIPOT WITH & WITHOUT LID



SS-8-5133
SPITTEN MUG



SS-8-5134
SPIRIT LAMP

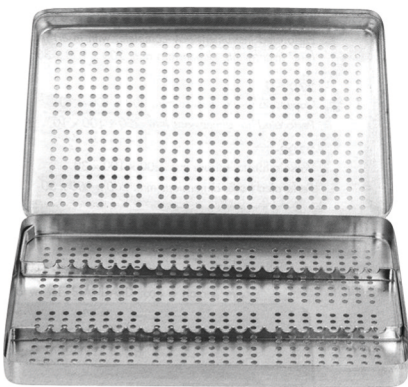

SS-8-5135
Perforated Tray



SS-8-5136
Perforated Base

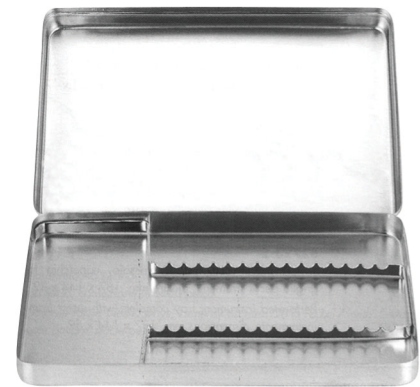

SS-8-5137
Solid Base



SS-8-5138
Instruments Tray



SS-8-5139
Instruments Tray



SS-8-5140
Instruments Tray
(Perforated)



SS-8-5141
Instruments Tray Shallow
(Mayo)



SS-8-5142
Scalers Tray



SS-8-5143
Catheter Tray

Alphabetical Index

A		
Adams	125, 133	
Aderer	133	
Adson	96	
Ainsworth	110	
Albee	77	
Albrecht	109	
Alcohol Lamp	142	
Alginate	93-94	
Allen	109	
Amalgam Carriers	117	
Amalgam Guns	117	
Amalgam Well	117	
Andresen	134	
Angle	133	
Antkoviak	78	
Apical	36, 44	
Arruga	97	
Articulators	140	
Ash	53, 88	
Aspirating Syringes	102	
B		
Band Adaptor	102	
Barry	47, 50	
Baumgarthner	96	
Beale	76	
Beebee	116	
Bein	33, 40	
Bennet	53, 123	
Beyer	121	
Bicuspids	114	
Birdbeak Pliers	132	
Blumenthal	120, 121	
Bohler	120	
Bohm	118	
Boley	77	
Bone Chisels	68	
Boynton	97	
Breech Loading Syringe	102	
Brewer	110	
Buck	61-63, 65	
Buckley	67, 124	
Burnishers	58	
C		
Caroll	77	
Castroviejo	77, 98, 100	
Cathetar Tray	144	
Cement Spatulas	91, 92	
Chompret	44	
Ck1	108	
CK2	108	
Cleveland	122	
College	105, 107	
Columbia	64, 66, 74	
Columbia	79	
Cone-Socket	90	
Cork Screw Tip	104	
Cotton Dispenser	142, 143	
Coupland	37	
Crane-kaplan	74	
Crile-Wood	96	
Crown Removers	115-116	
Cryer	35, 37, 48	
Curette	64, 66	
D		
De La Rosa	129	
Dental Probes	57	
Dental Syringes	103-104	
Derf	95	
Didner	113	
E		
Eliselberg-Mathieu	97	
Eliott	53	
Endo Finger Ruler	102	
Endo Tray Box	142	
Endodontic Box	142	
Ermert	78	
Excavators	87-88	
Explorers	81	
Extracting Forceps	01-31	
F		
Fahnenstock	79	
Filling Instruments	52-56	
Fischer	134	
Flagg	107	
Flohr	38	
Forcepps Jar	143, 144	
Fox	58	
Fraizer	100	
Freer	123	
Friedman	119-120	
Furrer	119	
G		
Gallipot	144	
Gardner	67, 122	
GF1	108	
GF2	108	
Gillies	96	
Goldman Fox	60, 63, 65, 73, 120	
Goslee	134	
Gouges	68	
Gracey Curettes	69	
Gracey Mesial Distal	69	
Gracey	56-69-72	
Gritman	76-78-80	
H		
Halstead-Mosquito	118	
Hegar-Baumgartner	95-96	
Heidbrink	45-48-50	
Heidemann	55	
Hemingway	75	
Henahan	123	
How	133	
Hylin	40, 76	
I		
Impression Trays	136-139	
Intra-Ligamental Syringes	104	
Irrigator	143	
Ivory	110, 113	
Iwanson	77	
J		
Jaquette	74	
Johnson	133	
K		
Kelly	118	
Kerrison	120	
Kidney Tray	143	
Kilian	124	
Kilian-Claus	124	
Klein	07	
Kleinert-Kutz	121	
Kopp	39, 49, 108	
L		
Landgraf	107	
Langenbeck	134	
Le Cron	76	
Lecluse	43	
Lessmann	79	
Lichtenberg	97	
Listion-mini	122	
London Hospital	41	
London-College	107, 109	
Lucas	75	
Luer	120	
Luks	84	

M			Rhodium			W		
Machtou	83		Rhodium	89	Wakefield			
Mallets	68		Roach	76	Waldron	67		
Mathieu	99, 100		Root Elevators	32--51	Waldsachs	133		
Matrix Bands	113, 114		Root Splinter	31	Warwick-James	130, 133		
Matrix Retainers	113		Root-Canal Excavators	86	Water Syringe	41		
Mayo-Hegar	95		Root-Canal Explorers	86	Weingart	101		
Mc Call	73		Root-Canal Plungers	84-85	White	129, 133		
Mc Kellops	133		Rubber Dam Clamps	111-112	Williams	52, 60, 83		
Mead	43, 58, 119		Rubber Dam Frame	110	Williger	123		
Measuring Jug	143		Ruskin-Mini	121	Winter	46, 50		
Measuring Plate	84				Woodson	54, 55		
Medicon	78		S					
Meriam	106, 109		Scalers	58				
Merrit A	60		Schell	119				
Mershon	110, 116		Schilder	85				
Micro-Barraquer	99-100		Schluger	61, 62				
Micro-Mosquito	118		Schwarz	134				
Miller	118, 124		Seldin	34, 48, 123				
Mini-Ryder	95		Spirit Lamp	144				
Molar	114		Spitten Mug	144				
Morell	116		Spreader	82-83				
Mouth Mirror Handles	89, 90		Sterilizing Boxes	142, 143				
Mouth Mirrors	89, 90		Sterilizing Drums	142				
MSY	76, 134		Sugarman	61, 162				
N			T			Y		
Nabers	83		Taylor	74	Young	133		
Nance	128, 133		Toennis	97	Younger-Good	73		
Niro	122		Tofflemire	114				
O			Tofflemire-Junior	113				
Obwegeser	124		Tofflemire-Senior	113				
Ochsenbein	61, 62, 67		Tofflemire-Universal	113				
Olsen-Heger	96		Towner Jaquette	74				
Oms	83		Towner	74				
Ott	41		Trays	144				
P			Treyman	116				
P.K. Thomas	76		Tweed	130				
P.K. Thomas	68		U					
Partsch	134		Univarsal "HM"	116				
Pocket Probes	58-60		Univarsal	128, 133				
Plaster Knives	80		University of Michigan	60				
Plaster Spatulas	93-94		USA Model	133				
Position Gauge	102							
Pott	42		V					
R			Vehe	76				
Rein	81		Vernier	77				
Relax	05		Vertical Condenser	83				
Reynolds	129							
Rhodes	61, 62							

WE HAVE ALL RANGE OF INSTRUMENTS



CONTACT INFO



+92-340 0473111



swisons.ind@gmail.com



www.swisons.com



Small Industrial Estate, Sialkot 51310 Pakistan

Get your high quality Instruments