

Get Your High Quality Instruments



VETERINARY INSTRUMENTS

Swisons Instruments is a brand for manufacturing quality instruments. An eminent name among Disposable & Reusable Veterinary instruments manufacturers in Pakistan. The **Swisons Instruments** features a wide range of products details are available on website and catalogue.

www.swisons.com

Set of Obstetric Instruments

Complete In Metal Case.
Containing Crutch (or Repeller),
Sharp Hook,
Sharp Hook With
Probe End,
Carrier For Rope,
Cutis Separator,
Handle For Separator,
Two Extension Pieces For Handle,
Two Large Curved Hooks,
Two Small Curved Hooks For Eye,
Two Nylon Ropes,
Embryotomy Knife
(guarded).
16-365



Blanchard's Obstetric Instrument

With long nylon stem, Blunt hook.
Length: 72cm (29in).
16-370



Obstetric Hook

21cm (8.5in) with movable ring.
Sharp.
16-375

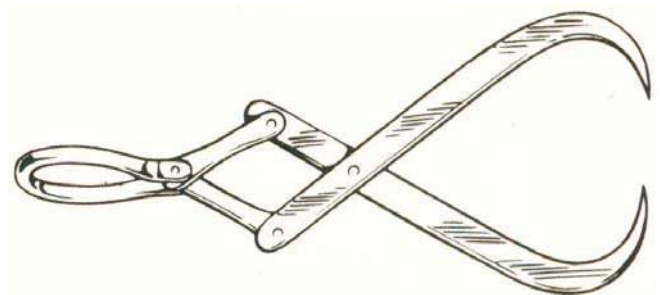

Eye Hook

65mm (2.55in)
16-380



Eye Hook

16-385 Small 8cm (3in)
16-390 Large 10cm (4in)

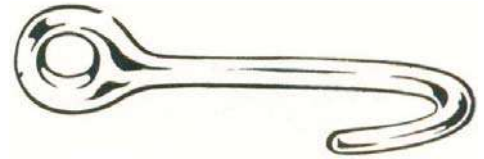

Eye Hook Pointed

16-395 Small 8cm (3in)
16-400 Large 10cm (4in)

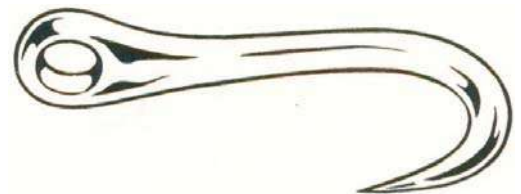

Moore's Obstetrical Chain

16-405 Length: 76cm (30in) Nickel Plated
16-410 Length: 152cm (60in) Nickel Plated

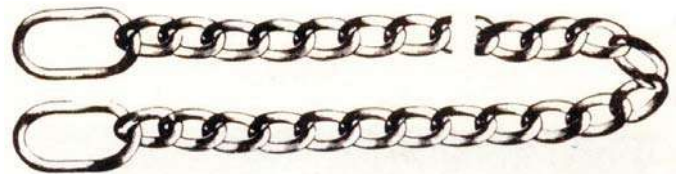

Moore's Obstetrical Chain

16-415 Length: 80cm (31.5in) Stainless steel
16-420 Length: 190cm (75in) Stainless steel

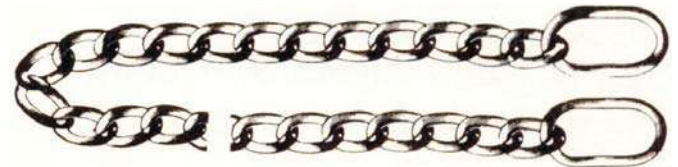

Arnold's Suture Needle

16-425 For vulva or rumenotomy 15cm (6in)



Holmes' Needle

For tape sutures, specially designed for rumenotomy, also for vulva sutures. 28cm (11in)
16-430



Embryotomy Knife

16-435 The Linde Pattern Ring Knife with Shaped Hand Piece

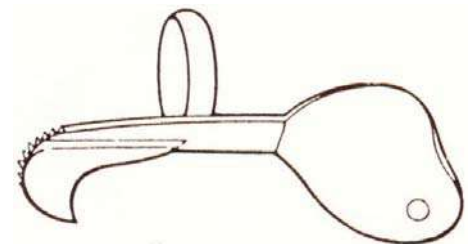

Charles Roberts' Embryotomy Knife

16-440

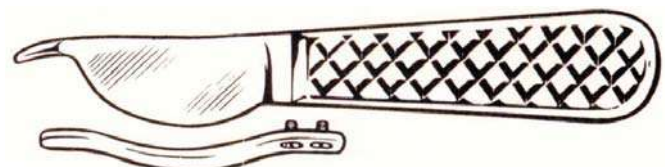

Cusco's Vaginal Speculum

Suitable for bitches, Length of blade: 7cm
Width: 14mm
16-445

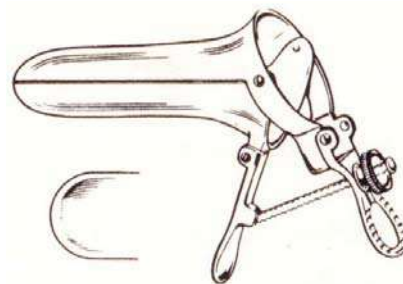

Cow Speculum Aluminium Russian Model

16-450 Complete with light attachment
16-455 As above but without light attachment
16-460 As above but half size
16-465 As above but without light attachment
16-470 Light attachment only
16-475 Battery Handle only
The above speculae also suitable for mares

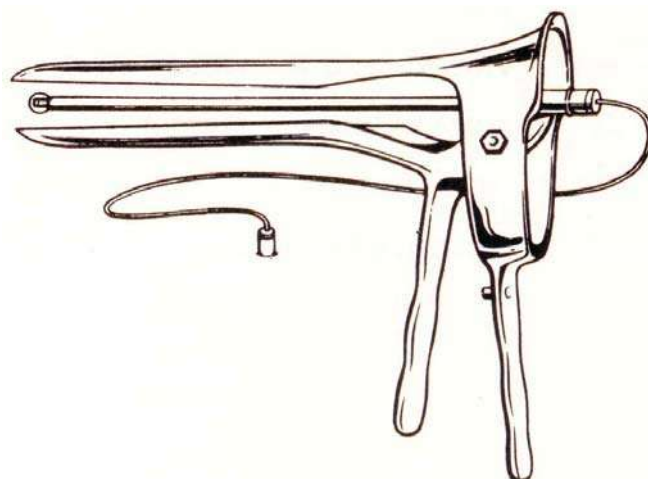

Kilian's Speculum

For use on small animals, Length of blades: 7cm
16-480

M Kilian's Speculum

Fitted with a stop, so that the blades can be left open at a set position, Length of blades: 7cm
16-485

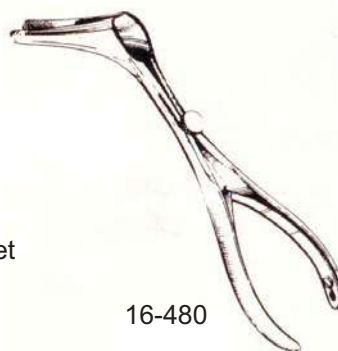

16-480

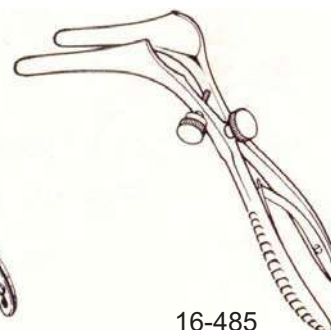

16-485

Neilson's Uterine Catheter

Single channel size 4mm, Luer fitting, Length: 43cm
16-490



Speying Forceps

127mm, Stainless steel.
16-495



Noel's Speying Hook

127mm, Stainless steel.
16-500



Miss Freak's Whelping Forceps

254mm (10in) Flexible jaws and ratchet, Stainless Steel.
16-505

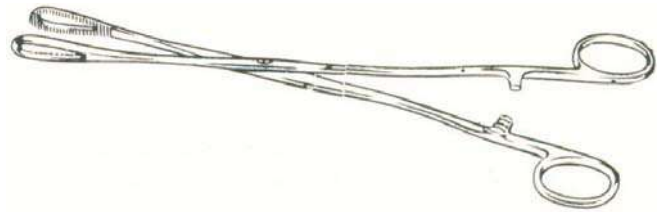

Sir Frederick Hobday's Double Vectis

241mm (9.5in) nickel plated.
Pass the vectis over the occiput or some other prominent part of the foetus and, by firm gentle pressure against the pelvis or against the finger, draw the foetus towards the vagina. The some instrument is suitable for both large and small dogs and is of great utility in a case of difficult labour.
16-510



Hughes Lambing Snare

To assist in the lambing of ewes.
The snare is particularly useful, where the maternal pelvis is narrow and deformed. Or where the lamb has an exceptionally large head, and there is insufficient room for hand, lamb's head and forelegs in the passage. Also useful in cases where the head of the lamb, persistently drops back into the uterus.
16-515

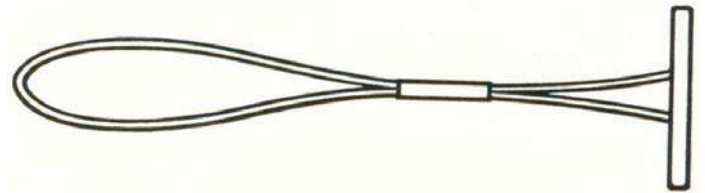

The Dal Lambing Instrument

Simplest, safest and surest aid to lambing problems. Save both the lamb and the ewe even in the most difficult cases. The instrument can be sterilizes in boiling water or in any reliable antiseptic.
16-520

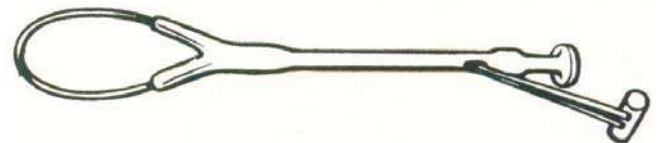

Papillotome or Teat Slitter

With adjustable width of spread.
Length: 18cm (7in).
16-525

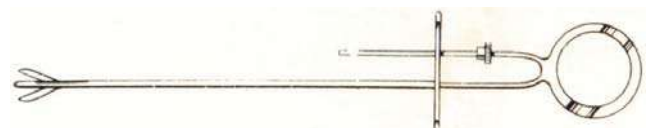

Teat Tube

With bulbous end to take rubber tubing.
16-530



Burdizzo Bloodless Castrators

- 16-535 Baby size 20cm (8in) long
- 16-540 Small size 30cm (12in) long
- 16-545 Medium size 33cm (31in) long
- 16-550 Large size 40cm (16in) long
- 16-555 Indian size 48cm (19in) long

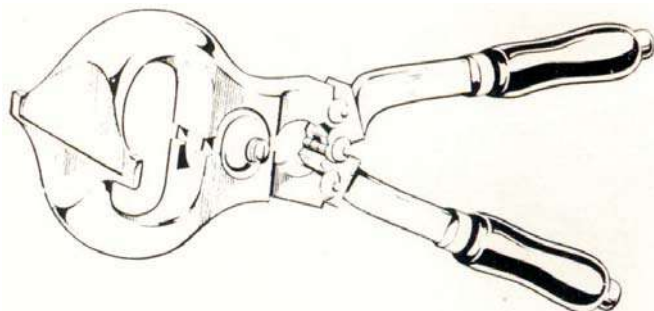

Modified 'Serra' (Crowhurst)

Curved handles and without ratchet.
 Chrome plated. Recommended for colts. For Equine use.
 16-560



'Serra' Emasculator

Overall length: 36cm (14cm). Triple crush with thumb-screw for separating and cleaning. Recommended for colts.
 Chrome plated, For Equine use.
 16-565

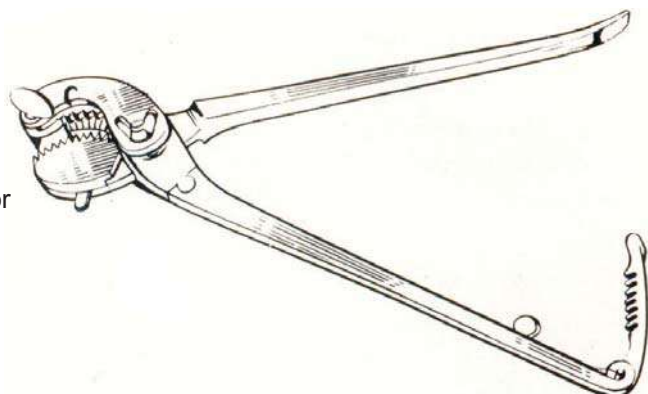

Arnold's Tumor Extractor Long Pattern

16-570



McLean's Teat Knife

5mm For severing the sphincter muscle of the teat canal.
 16-575
 As above but 7mm
 16-580



Hall's Teat Knife

Three sided cutting edge. 4mm
 16-585
 As above but 5mm
 16-590



Hudson's Teat Instruments

- 16-595 Small - 138mm corkscrew pattern
- 16-600 Medium - 140mm corkscrew pattern
- 16-605 Large - 150mm corkscrew pattern
- 16-610 Probe - 170mm

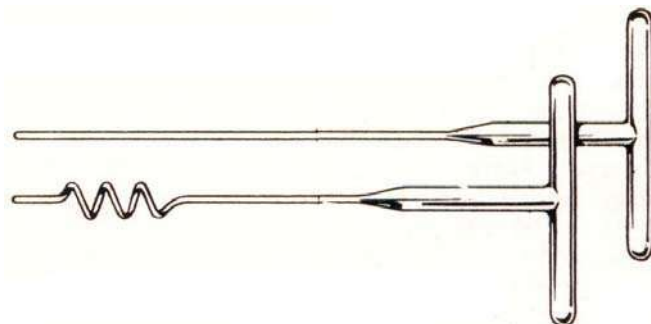

Hodges Dehorner

- 16-615 All metal with curved blades. Length: 43cm (17in).
- 16-620 Spare blades for this device.

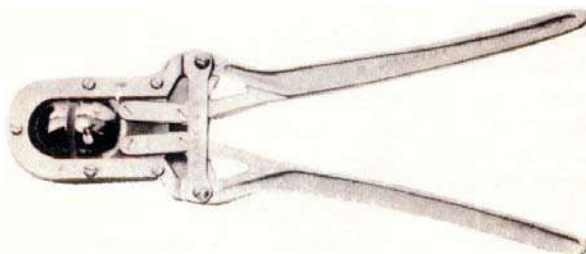

Bull Nose Punch with Removable Nipple

- 16-625 Complete
- 16-630 Spare Nipples for this Device.

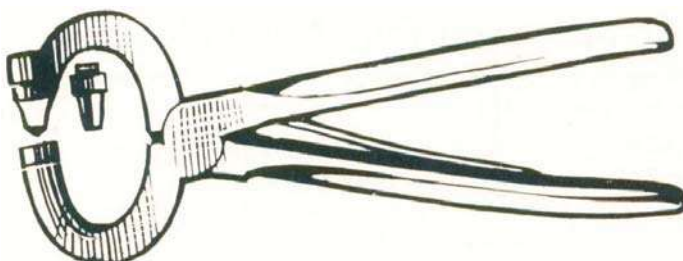

Copper Bull Rings

Strong 3/8in thick with pointed end. Self-piercing with break-off screw. Superior quality.

- 16-635 5.7cm
- 16-640 6.3cm
- 16-645 6.9cm
- 16-650 7.5cm
- 16-655 10.2cm

Stainless Steel Bull Rings

- 16-660 6.9cm
- 16-665 7.5cm



Stainless Steel Pig

Not illustrated.
16-670

Pig Tooth Forceps

Standard quality. Chrome plated for cutting milk teeth.
16-675

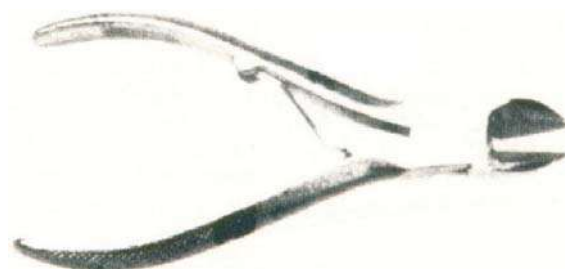

Sealing Pliers

One-handed sealing pliers for applying permanent ear tags in one simple action.
16-680

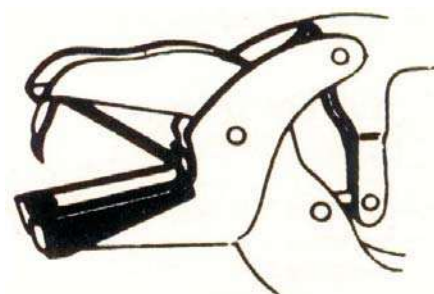

Foot Rot Shears

With strong spring and safety clip, Specially designed blades of tempered steel, one being serrated.

16-685

16-690 Spare blades for shears.

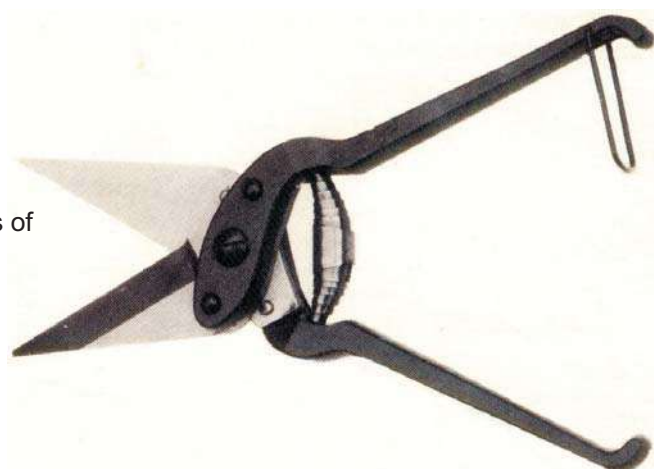

'Compression' Punch and Closer

Single-handed action. Punches, closes, rivets and releases in one movement.

16-695 Punch and closer for sheep

16-700 Punch and closer for cattle

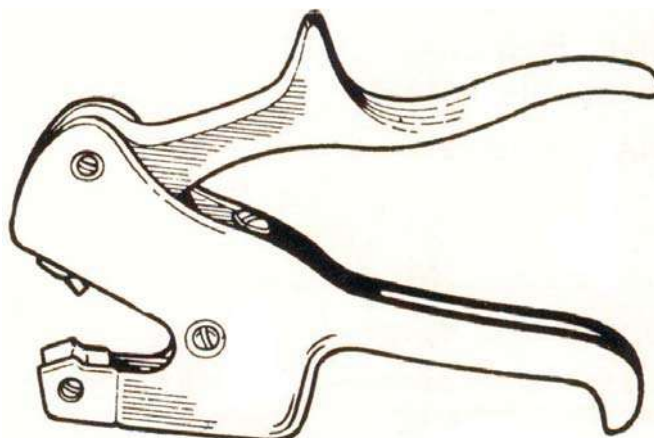

Eye Speculum

Spring Barraquer's, Stainless steel.
16-705

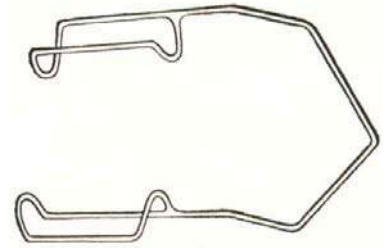

Nettleship's Canaliculus Dilator

Straight tapered end, 10cm (4in) overall.
16-710



Lang's Canaliculus Dilator

Straight tapered end, 10cm (4in) overall.
16-715



Graefe's Knife

Length: 12.7cm (5in)
16-720



Dehorning Saw

16-725 With interchangeable blades, 40.5cm (16in)
16-730 Spare blades

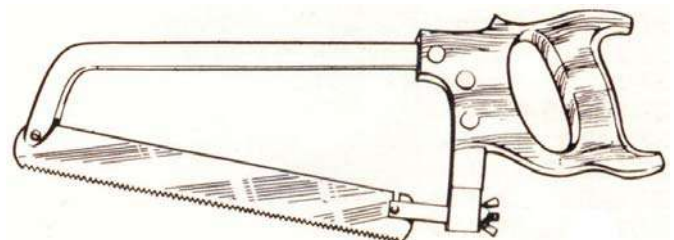

bull holder

Superior all Stainless steel with sliding catch. Length: 19.68cm
16-735



Strengthen Grip

Short model, Flat handles
Length: 21.95cm
16-740

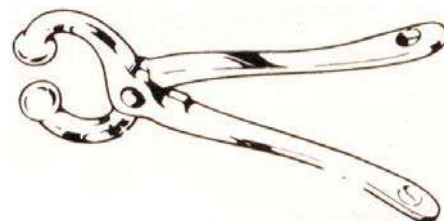

Irish Pattern

Length: 45cm
16-745



Galvanised Steel

With spring, Superior Quality
Length: 11.43cm
16-750

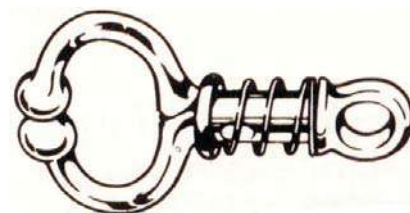

Bull Holders

With slide and spring, folding handle.
Length: 18cm
16-755

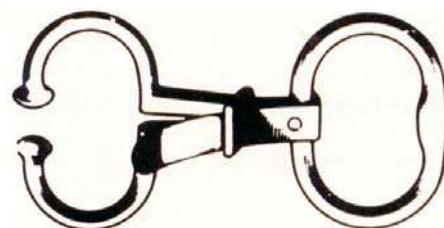

Pig Holder

Wire Nose Type with Metal Pole.
16-760



Pig Holder

Wire Nose Type.
16-765

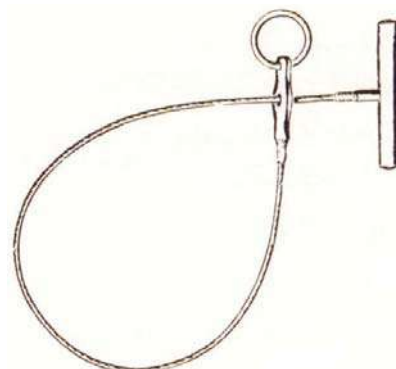

Stainless Steel Cattle Trocar

16-770 Complete with 10 Disposable Cannula and Cap.
16-775 Spare disposable Cannula in packs of 10



Cattle Trocar and Cannula

16-780 Stainless steel trocar, Chrome plated cannula fitted with protecting cap, Length of cannula 11.4cm.
16-785 Spare cannula for above.

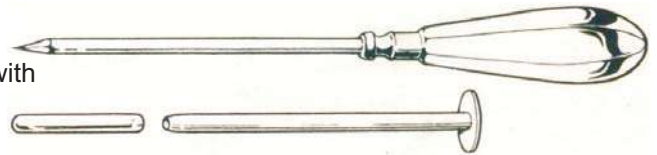

Nocard's Trocar

Used widely for Bleeding horses.
16-790

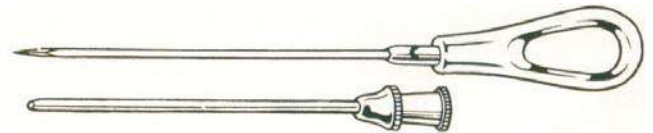

Complete Sheep Trocar

16-795

Cannula Only

16-800

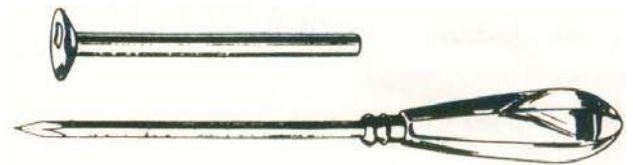

Hoof Testing Forceps

Length: 30.5cm (12in)
16-805

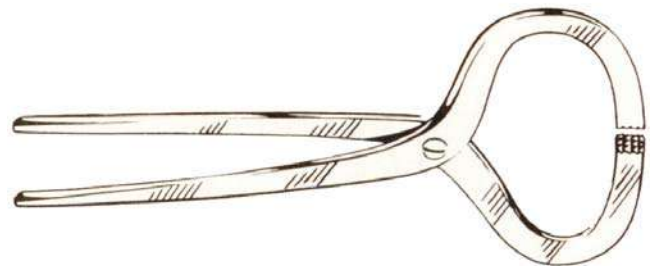

Hoof Pick with Screwdriver

Folding Type, Length Closed: 7.5cm
Length Open: 11.43cm
16-810

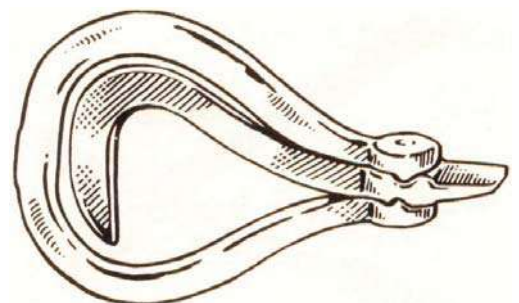

German Hoof Knives

16-815 Single edge, Right

16-820 Single Edge, Left

16-825 Double Edge, Right

16-830 Searcher, Single Edge, Right

16-835 Searcher, Single Edge, Left

16-840 Searcher, Ebony (Black Handle). Right

16-845 Searcher, Ebony (Black Handle). Left



Swedish Hoof Knives

16-850 Single Edge, Right

16-855 Single Edge, Left

16-860 Searcher, Right

16-865 Searcher, Left

16-870 Double edge, Right



Quittor Knife

All metal Quittor Knife, German, Length:18cm
16-875



Farriers Set

Farriers |Set Comprised of:

- 16-880 One Canvas Holdall Containing.
- 16-885 One Farriers Pincer
- 16-890 One Farriers Hammer
- 16-895 One Farriers Hoof Cutter
- 16-900 One Farriers Buffer
- 16-905 One Farriers RASP
- 16-910 One Farriers Double Edge Hoof Knife
- 16-915 One Farriers Searcher Knife

Items also available separately

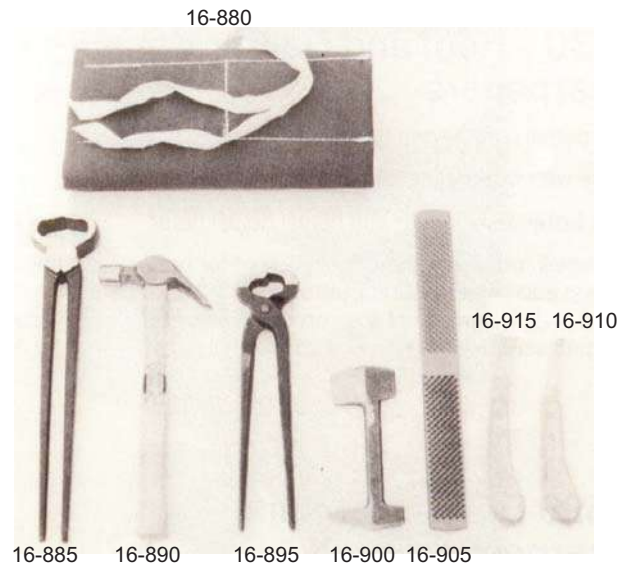

Hoof Cutter

German Pattern, Single Action.
16-920



Hoof Cutter

The Popular Compound Action Hoof Cutter,
Removable Blades for Sharpening or Replacement.
16-925

Replacement Blades for Above.
16-930



Tenaculum (Neurectomy Needle)

The Size, Shape and Contours of the Tenaculum Make it
Suitable for the Isolation of Nerve Trunks and for the Passage
of Ligatures Around Vascular Elements.
16-935

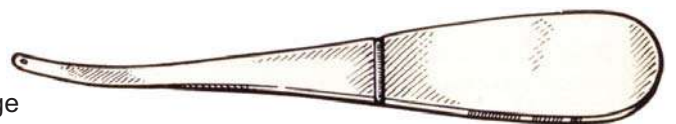

Dieffenbach's Artery Forceps

Stainless Steel 40mm (1.6in) Approximately.
16-940



Halstead's Mosquito Artery Forceps

Box Joint, Stainless Steel.

16-945 127mm (5in) Straight.

16-950 127mm (5in) Curved.

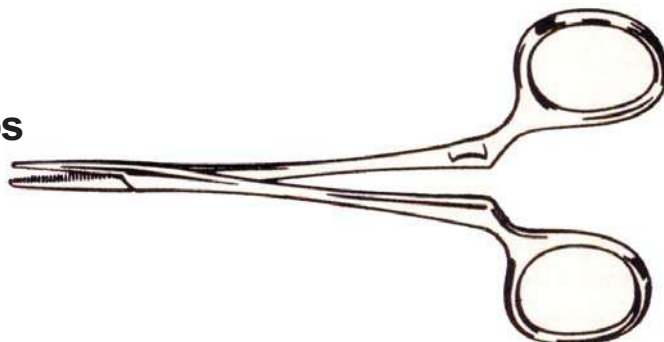

Spencer Well's Artery Forceps

Box Joint, Straight.

16-955 127mm (5in)

16-960 152mm (6in)

16-965 178mm (7in)

Box Joint, Curved.

16-970 127mm (5in)

16-975 152mm (6in)

16-980 178mm (7in)

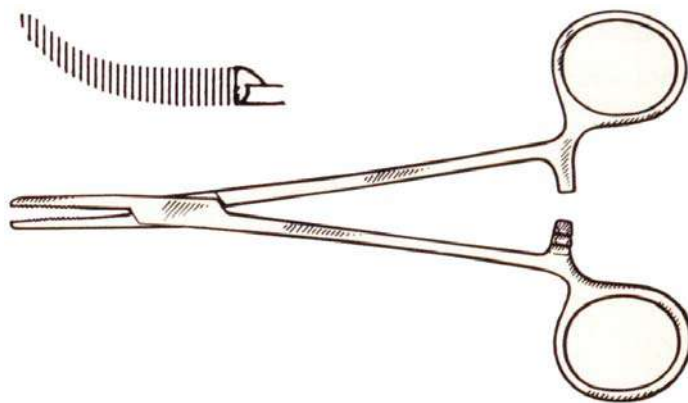

Rochester Pean Forceps

16-985 165mm (6.5in) Straight

16-990 165mm (6.5in) Curved

Blade Lengths: 51mm (2in).

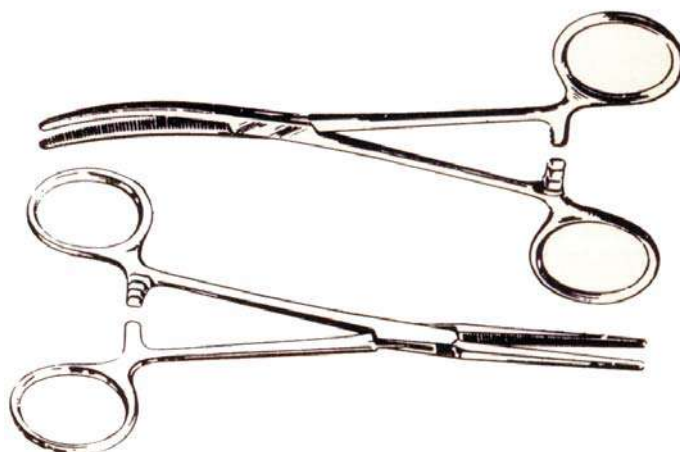

Travers Retractor

16-995 For Small Animal Surgery, Self-Retaining, Stainless Steel, Gap When Fully Open Approximately 95mm.

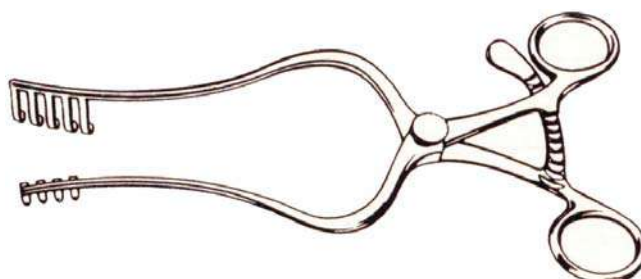

Fergusson's Angiotribe Forceps

- 17-100 Straight, Length: 165mm.
- 17-105 As Above, But Curved on Flat, 165mm.

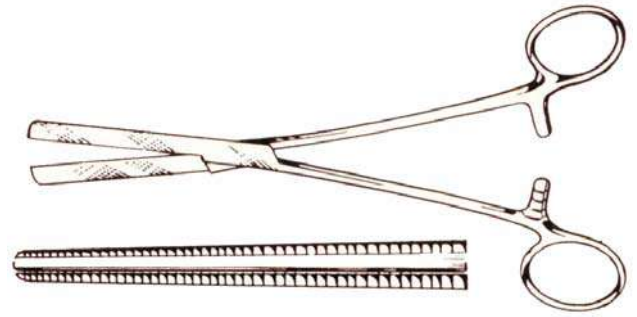

Criles Artery Forceps

- 17-110 Straight, Length: 140mm.
- 17-115 Curved, Length: 140mm.

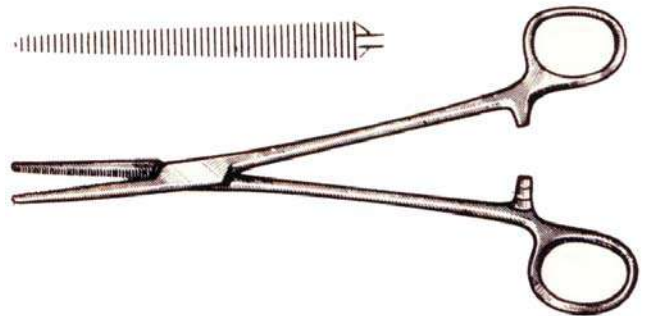

Cairns Artery Forceps

- 17-120 Straight, Box Joint, Stainless Steel 152mm.

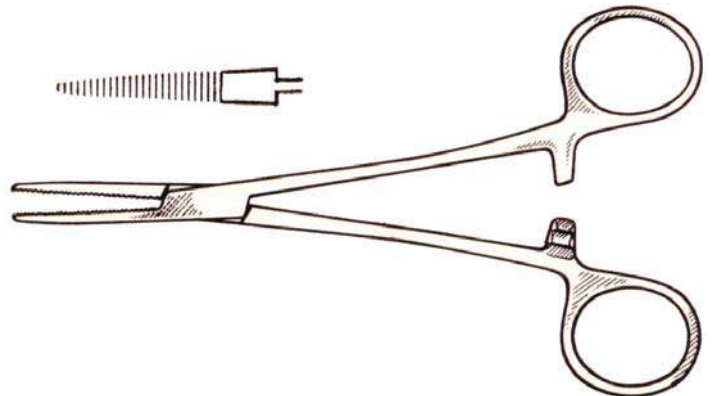

Gossett's Retractor

- Self-Retaining, Stainless Steel.
- 17-125 Large, Fully Open 95mm.
- 17-130 Small, Fully Open 76mm.

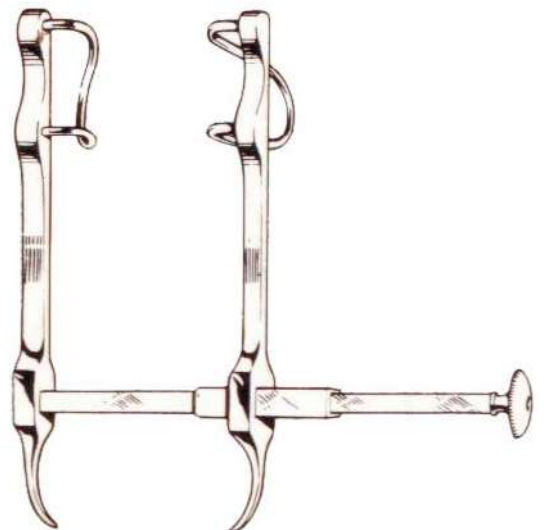

Paragon No.4 Knife Handle

17-135 To Hold Blades Nos. 20, 21, 22, 23 and 24.



Paragon No.3 Knife Handle

17-140 To Hold Blades Nos. 10, 11, 12, 23 and 15.



Arnolds Tenotomy Knife

Special Pattern Designed by a Veterinary Surgeon for Tendon Splitting.

17-145



Plaster Shears

Finest West German Stainless Steel, Eccentric Featuring Off-set Screw for Greater Power 190mm Long with Serrated Edge.

17-150



Bandage Shears

For Removing Adhesive Bandages, Stainless Steel 178mm.

17-155

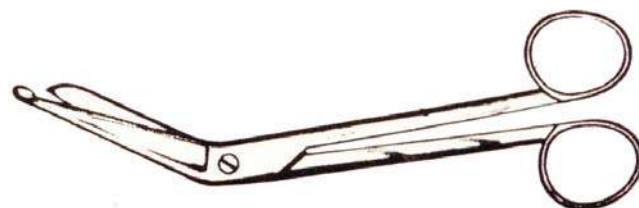

Mayo's Scissors

17-160 Curved on Flat Stainless Steel 140mm

17-165 Curved on Flat Stainless Steel 165mm

17-170 Curved on Flat Stainless Steel 190mm

17-175 Straight, Stainless Steel 140mm

17-180 Straight, Stainless Steel 165mm

17-185 Straight, Stainless Steel 190mm

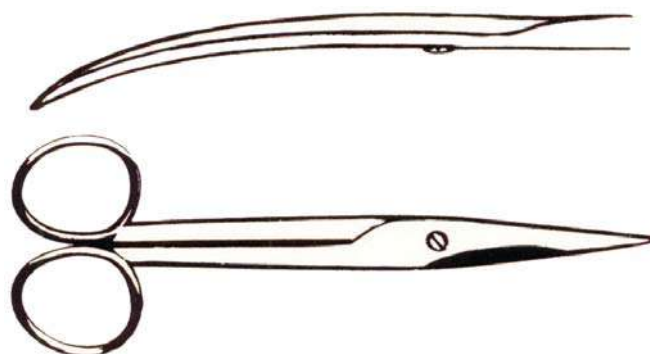

Gillie's Combined Scissors and Needle Holder

Designed to aid repidity of Operation and to Save Time, It Combines the Functions of Two instruments in One, Comfortable Grip, Stainless Steel.

17-190 Right Hand

17-195 Left Hand

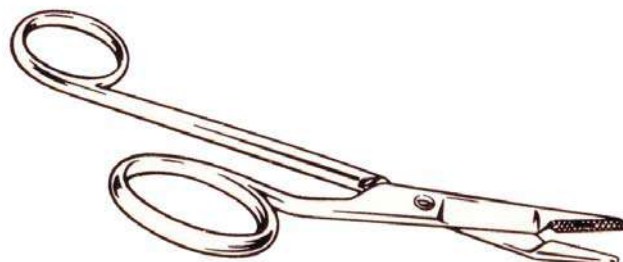

Scissors

- 17-200 Round Point, Straight, Stainless Steel, 127mm
- 17-205 Round Point, Straight, Stainless Steel, 152mm
- 17-210 Round Point, Straight, Stainless Steel, 178mm

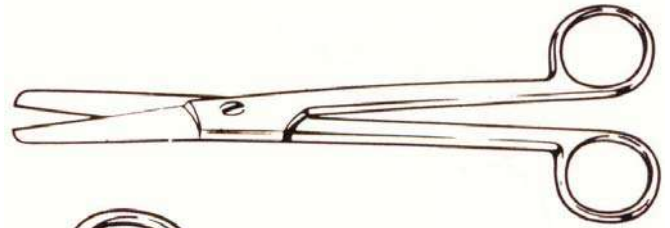

- 17-215 Vigo Point, Straight, Stainless Steel, 127mm
- 17-220 Vigo Point, Straight, Stainless Steel, 152mm
- 17-225 Vigo Point, Straight, Stainless Steel, 178mm

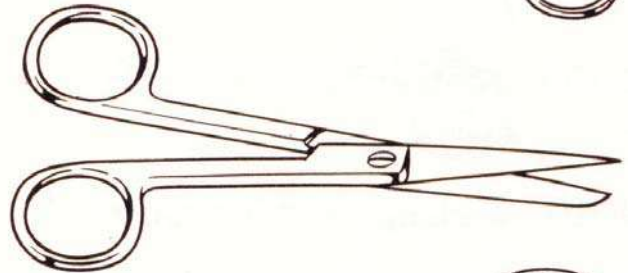

- 17-230 With One Probe Point, 127mm

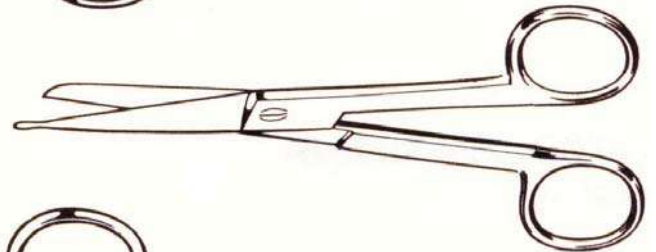

- 17-235 Sharp Point, Straight, Stainless Steel, 127mm
- 17-240 Sharp Point, Straight, Stainless Steel, 152mm
- 17-245 Sharp Point, Straight, Stainless Steel, 178mm

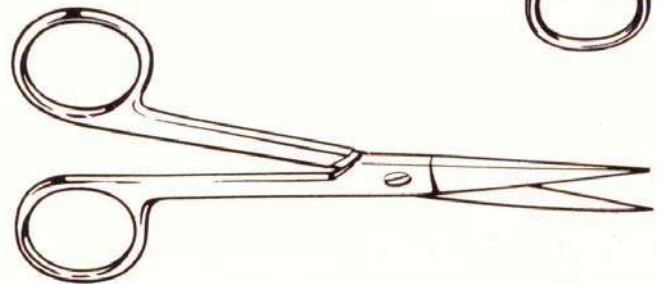

- 17-250 Round Point, Curved on Flat, Stainless Steel, 127mm
- 17-255 Round Point, Curved on Flat, Stainless Steel, 152mm
- 17-260 Round Point, Curved on Flat, Stainless Steel, 178mm
- 17-265 As Above With One Serrated Blade, 152mm

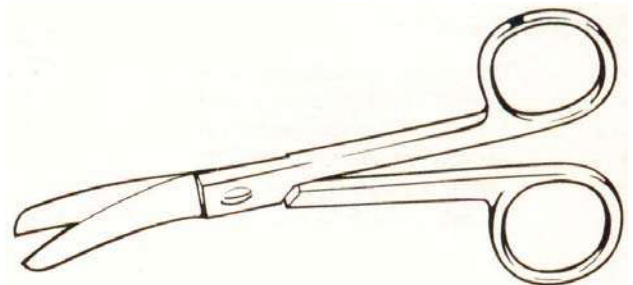

Cockade Barber Scissors

- 17-270 178mm

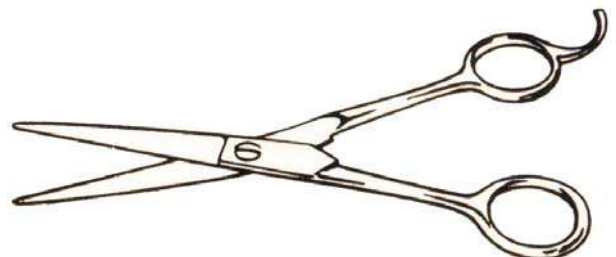

Payne's Suture Scissors

For Suture Removing, Length : 100mm
17-275

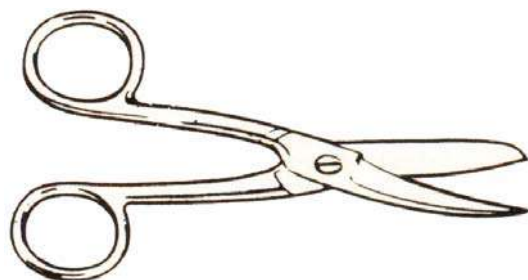

Heath's Stitch Scissors

Stainless Steel 152mm
17-280

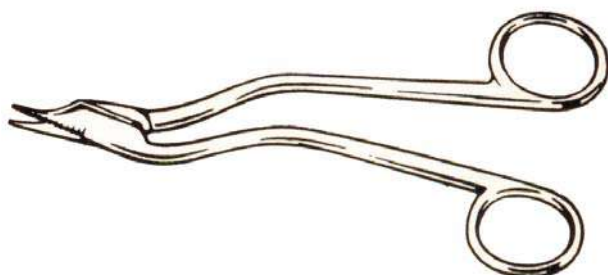

Littauer Stitch Scissors

17-285 152mm

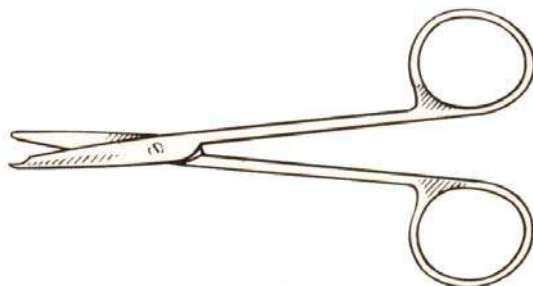

Metzenbaum Scissors

17-290 Straight, 178mm
17-295 Curved, 178mm

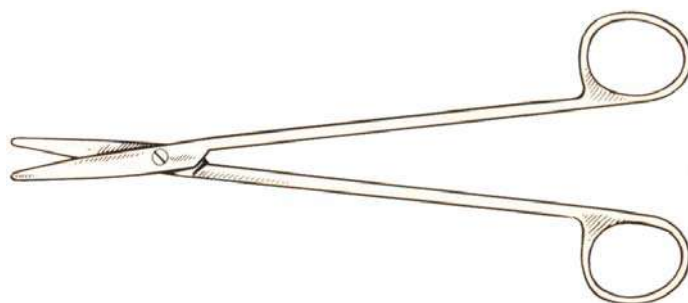

Dog Nail Scissors

17-300 Nickel Plated

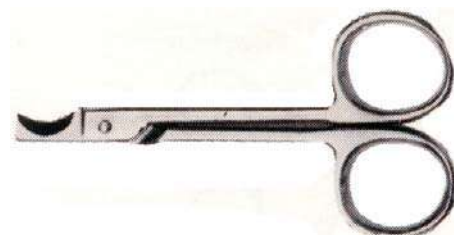

Silvamatt

A Range of Economy Surgical Instruments that are Offered at Extremely Competitive Prices. They are Made with a Non-Reflective Satin Matt Finish.

306-006-130 Blunt Point, Straight Scissors 130mm.



306-008-150 Blunt Point, Straight Scissors 150mm.



306-026-130 Vigo Point, Straight Scissors 130mm.



306-028-150 Vigo Point, Straight Scissors 150mm.



306-046-130 Sharp Point, Straight Scissors 130mm



306-048-150 Sharp Point, Straight Scissors 150mm



306-105-130 Blunt Point, Curved Scissors 130mm



306-106-145 Blunt Point, Curved Scissors 145mm



306-150-145 Straight Scissors 140mm



306-152-170 Mayo Straight Scissors 165mm



306-155-145 Mayo Curved Scissors 140mm



306-157-170 Mayo Curved Scissors 165mm



310-229-125 Treves Dissecting Forceps, 127mm



310-230-150 Treves Dissecting Forceps, 152mm



310-240-125 Bendover Dissecting Forceps, 127mm



310-241-150 Bendover Dissecting Forceps, 152mm



310-286-170 Lanes Dissecting Forceps, 178mm



327-345-140 Hartmann Aural Forceps (Matthew'w) 140mm



308-028-140 Criles Box Joint Artery Forceps Straight 140mm



308-029-140 Criles Box Joint Artery Forceps Curved 140mm

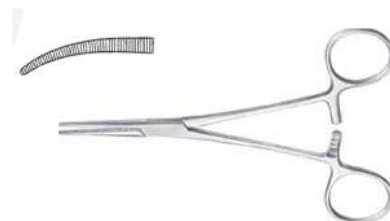

308-199-130 Dunhills Box Joint Artery Forceps, 130mm

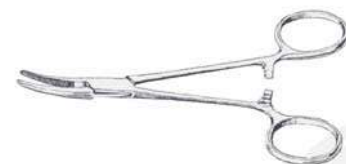

308-027-127 Halsteads Box Joint Artery Forceps, Straight 127mm



308-029-127 Halsteads Box Joint Artery Forceps, Curved 127mm

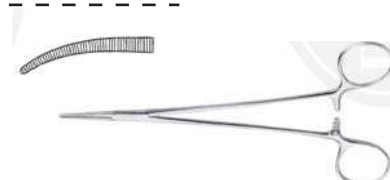

308-173-125 S/Wells Box Joint Artery Forceps, Straight 12.5mm



308-175-155 S/Wells Box Joint Artery Forceps, Straight 155mm



308-176-180 S/Wells Box Joint Artery Forceps, Straight 178mm



308-178-125 S/Wells Box Joint Artery Forceps, Curved 12.5mm



308-180-155 S/Wells Box Joint Artery Forceps, Curved 155mm



308-181-180 S/Wells Box Joint Artery Forceps, Curved 180mm



312-112-160 Gillies Needle Holder and Scissors 160mm



308-511-090 Cross Action Towel Clips



308-514-090 Jones Towel Clips



Bendover Forceps

Dissecting, Stainless Steel.

17-465 127mm

17-470 152mm

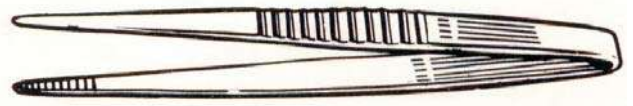

Bruce Clarke's Needle Holders

Combined Needle Holder and Artery Forceps,
Screw Joint, Stainless Steel 127mm.

17-475

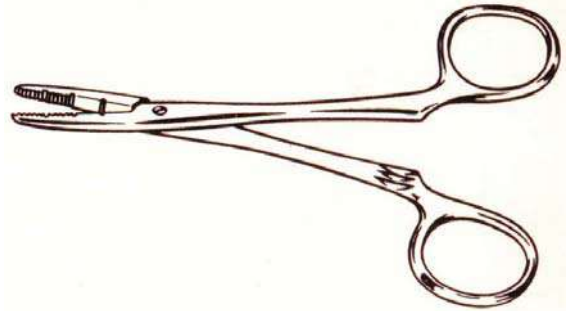

MacPhail's Needle Holder

With follow through' release, Screw Joint,
Stainless Steel, Copper Facing to jaws, 152mm.
17-480

17-485 As Above 178mm

17-490 As Above 203mm

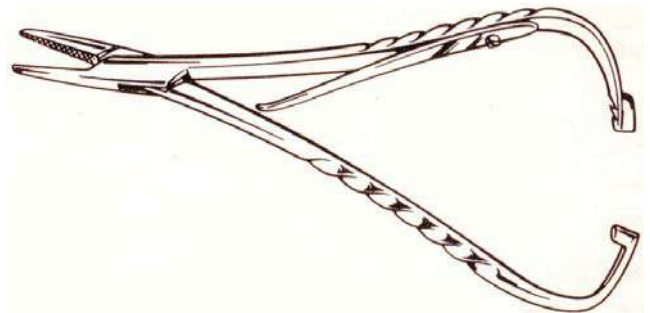

Gillie's Combined Scissors & Needle Holder

Designed to Aid repidity of Operation and to Save Time,
It Combines the Functions of Two Instruments in One,
Comfortable Grip, Stainless Steel.

17-495 Right Hand

17-500 Left Hand

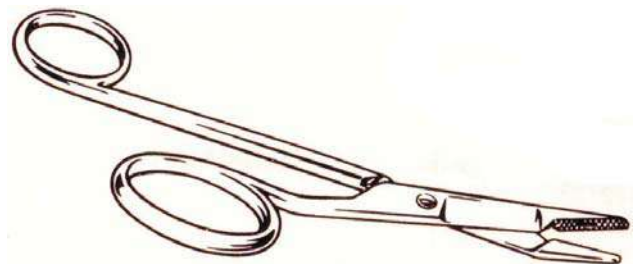

Olsen Hegars Needle Holders

17-505 16.5cm

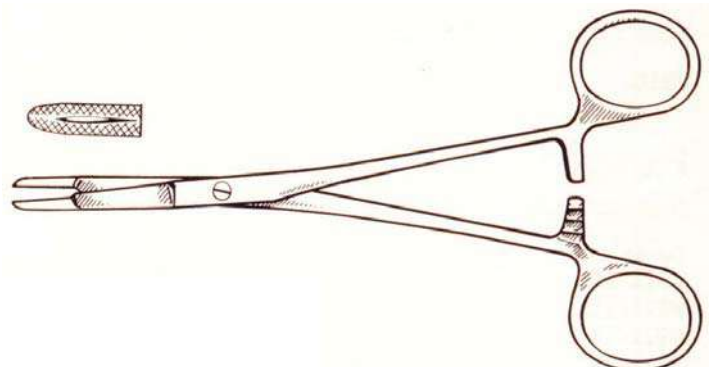

Miller Forge Nail Clipper

17-510

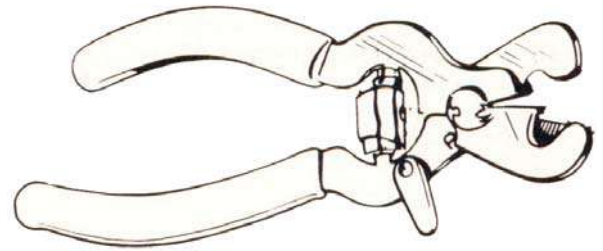

Nail Clipper

Stainless Steel, Very Powerful Compound Action.
17-515

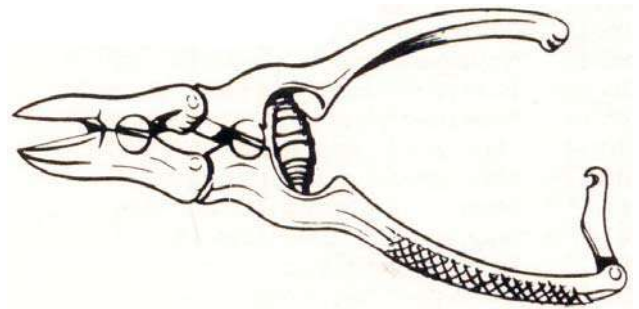

Heavy Duty Nail Clipper

Very Powerful Nail Cutter With Comfortable Handles
and 'Lock-Shut' Ever, Overall Length: 170mm.
17-520

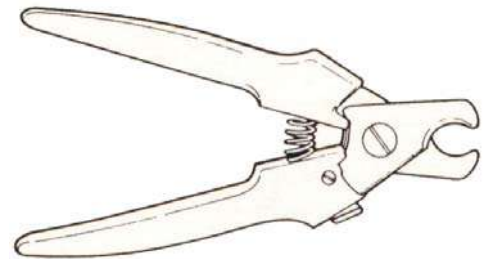

Nail Clipper

Nickel Plated.
17-525

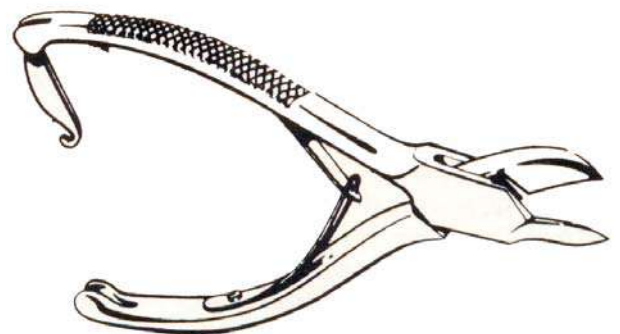

Resco Guillotine Nail Clipper

17-530

Resco Guillotine Nail Clipper. Jumbo Size

17-535

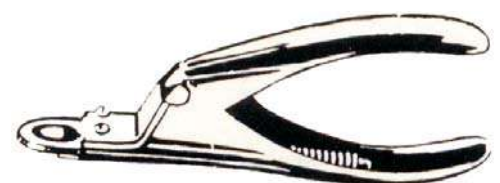

Backhaus' Towel Holding Forceps

Screw Joint, Stainless Steel 89mm.
17-540

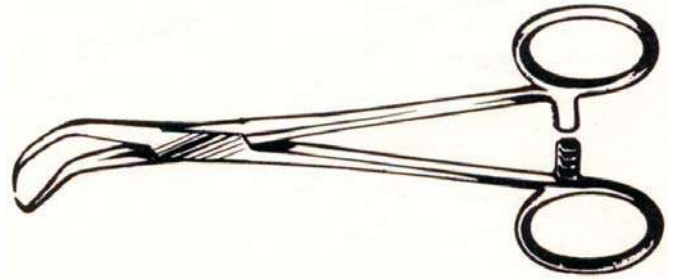

Lane's Tissue Forceps

17-545 195mm.

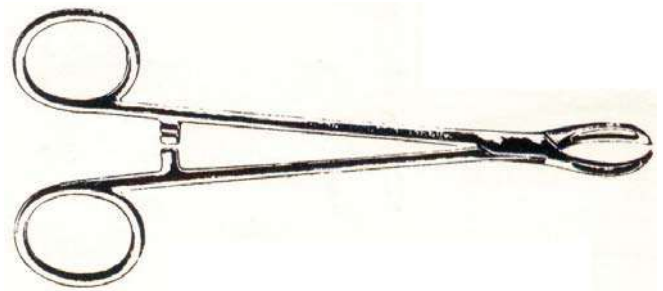

Allis Tissue Forceps

Box Joint, Stainless Steel, 152mm.
17-550

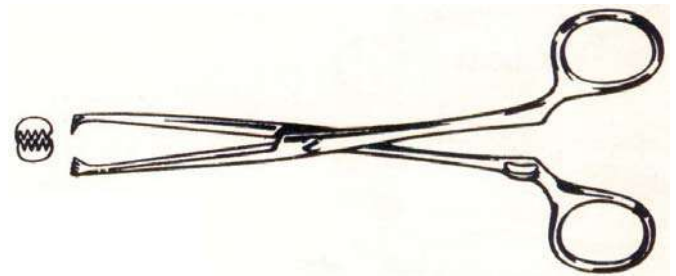

Noel's Speying Hook

Stainless Steel, 127cm.
17-555

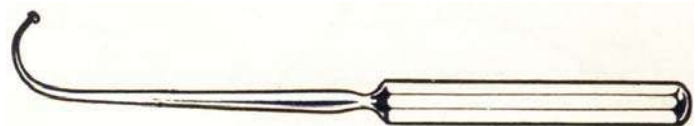

Doyen's Intestinal Clamp

Curved on Flat, Box Joint, with 105mm Blade,
Overall Length 240mm, Stainless Steel.
17-560

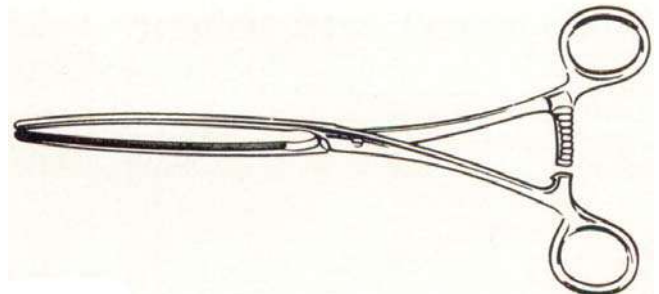

Doyen's Intestinal Clamp

Straight, Box Joint, with 95mm Blade,
Overall Length 215mm, Stainless Steel.
17-565

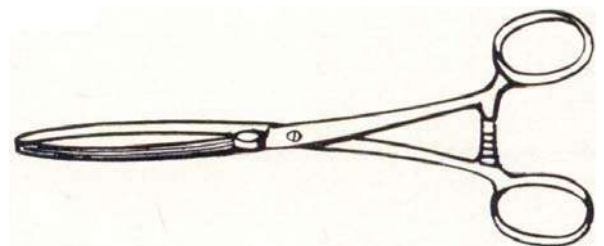

Lane's Intestinal Clamp

Straight, 19cm, Blade 7.5cm, Stainless Steel.
17-570

Michel's Forceps

For Inserting Michel's Clips, Stainless Steel.
17-575



Michel's Forceps

Double Ended for Inserting and Removing Michel's Clips, Stainless Steel.
17-580



Lane's Forceps

Dissecting, 1x2 teeth, Stainless Steel.
17-585 140mm
17-590 152mm
17-595 178mm



Treves's Forceps

Dissecting, 2x3 teeth, Stainless Steel.
17-600 127mm
17-605 127mm 2x3 teeth
17-610 152mm
17-615 152mm 2x3 teeth

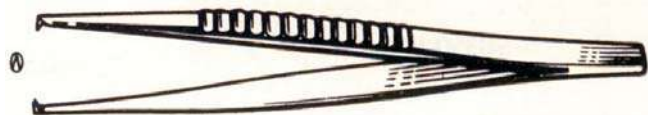

Speying Forceps

127mm, Stainless Steel.
17-620



Towel Clip

Cross Action, Stainless Steel, 80mm, Superior Quality.
17-625



Towel Clip

Cross Action, Standard Quality.
17-630

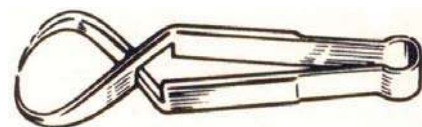

Lane's Interstinal Clamp

Straight 19cm, Blade 7.5cm, Stainless Steel.
17-635

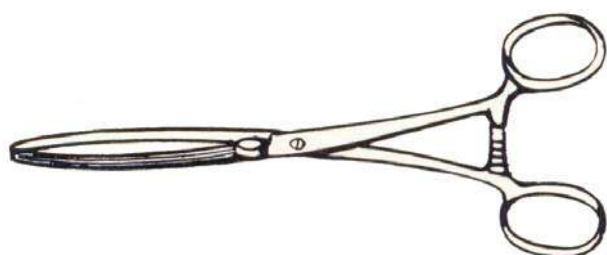

Tooth Extractors

Straight, Stainless Steel, For Upper Molars,
Length: 165mm.
17-640



Professor McCunn's Dental Forceps

For Small Animals, Serrations on Jaws with Gripping Teeth.
Length: 152mm
17-645

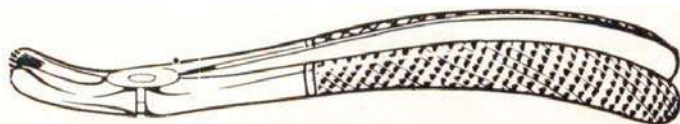

Dental Forceps

Fragments, for Small Animals, Length: 152mm.
17-650



Dental Forceps

Stumps, for Small Animals, Length: 152mm.
17-655

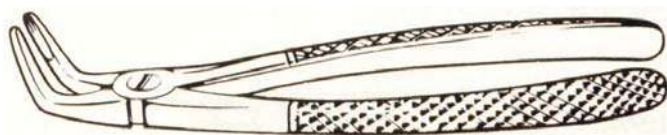

Tooth Extractors

Curved, Stainless Steel, For Lower Molars,
Length: 165mm.
17-660

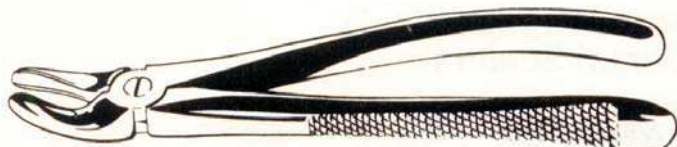

Tooth Extractors

For Fragments, Length: 178mm.
17-665



Coupland's Dental Chisel

17-670 127mm

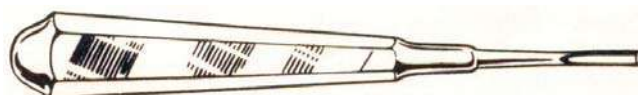

Dental Elevator

For Small Animals, Straight.
17-675



Gray's Mouth Gag

- 17-680 Small, 5.4cm Max, Opening.
- 17-685 Medium, 8.89cm Max, Opening.
- 17-690 Large, 12.7cm, Max, Opening.
- 17-695 Special Cat Size, 2.7cm Max, Opening.
- 17-700 Spare Rubbers for Mouth Gag (Pair).
- 17-705 Spare Spring for Mouth Gag.

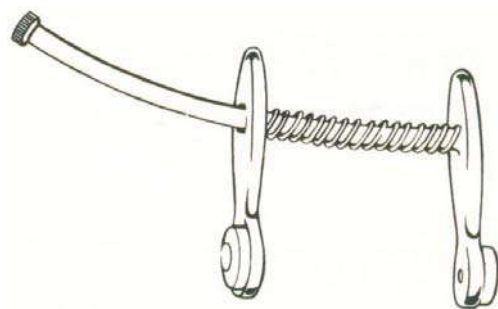

Dental Scalers

- 17-710 11
- 17-715 12
- 17-720 15
- 17-725 16
- 17-730 16 D/E

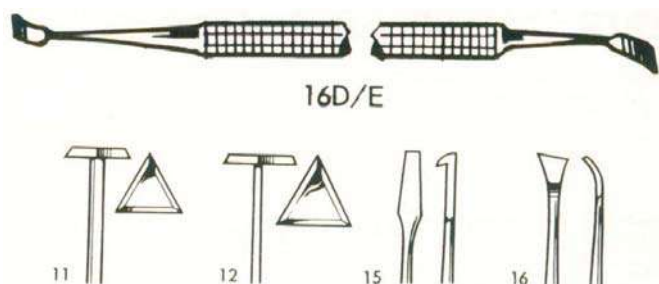

Brodie's Dental AWL

To Facilitate Fracture Repair of the Feline Mandibular Symphysis or Pars Incisiva as Commonly Encountered in Small Animal Practice.
17-735

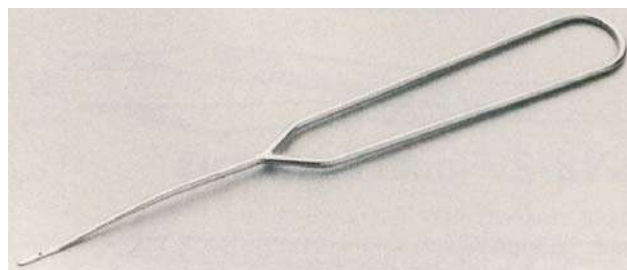

Tooth Extractors

For Wolf Teeth, Half Angled, Length: 260mm, Jaws Close Fully.
17-740

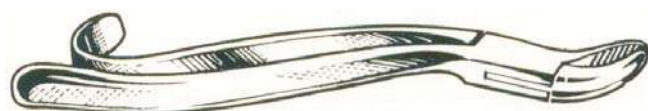

Reynold's Tooth Extractors

Lower Jaw, Length: 38cm.
17-745



Reynold's Tooth Extractors

Upper Jaw, Length: 38cm.
17-750



Tooth Extractors

For Wolf Teeth, Fully Angled, Length: 260mm, Jaws Close Fully.
17-755

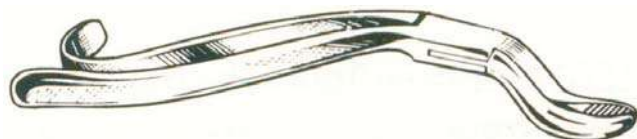

Army Pattern Tooth RASP

17-760 For Upper and Lower Jaws. Interchangeable Heads and RASP Blades, Complete with Two Heads, Angled and Straight.

17-765 Spare Screws.

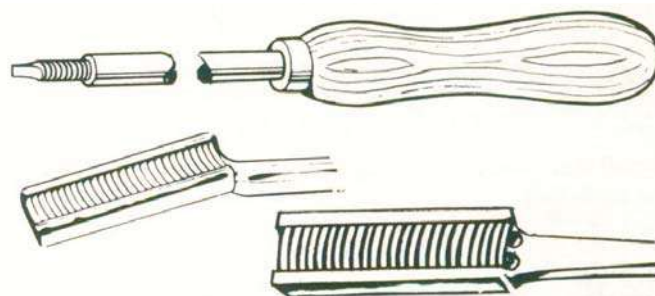

Horse Tooth RASPS

Stainless Steel to Take Replaceable Blades, Lightweight and angled for upper Jaws, Size: 46cm (18in).

17-770

(XL)

As Above but 61cm.

17-775



Multi-Angled Tooth RASP

Stainless Steel, Overall Length: 46cm.

A Multi-Angled Tooth RASP, That Allows the User to RASP Upper and Lower Molar Teeth, Merely by Changing the Position of The Head.

17-780

(XL)

As Above, But Overall Length: 56cm.

17-785



Tungsten RASP Blade

Single Sided, Tungsten Chip Blade for Fast and Efficient Rasping.

17-790

Spare Allen Key for RASP.

17-795

Spare Grub Screws for Rasps.

17-800

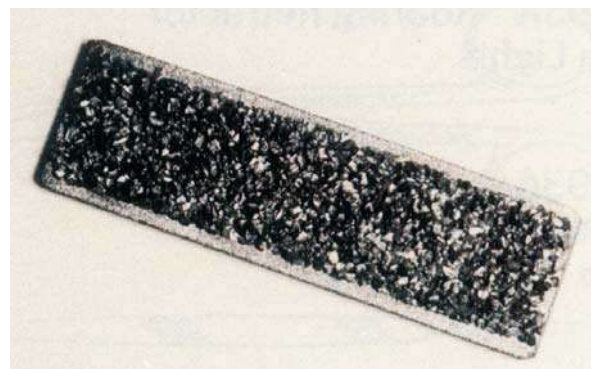

Bindloss' Dental Chisel

For Extracting Wolf Teeth in Young Horses.
17-805

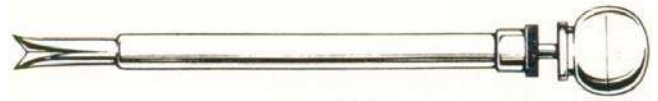

Lachrymal Cannula

Metal Luer Fitting, Length: 3.81cm.
17-810

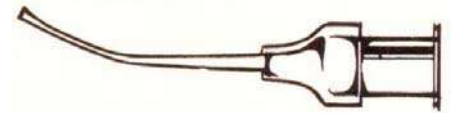

Lang's Lachrymal Cannula

Silver, Long Curve, Luer Lock.
17-815



Fixation Forceps

Stainless Steel, 1x2th, Length: 15.24cm.
17-820



Iris Forceps

Stainless Steel, 1x2th, Straight: 10cm.
17-825



Iris Forceps

Stainless Steel, 1x2th, Curved: 10.16cm.
17-830

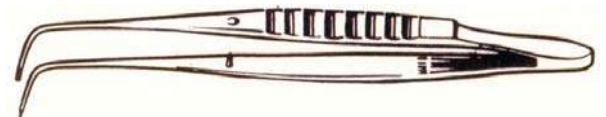

Iris Forceps

Serrated, Straight, Length: 10.16cm.
17-835



Iris Forceps

Serrated, Curved, Length: 10.16cm.
17-840



Iris Forceps

1x2th, 9.5cm.
17-845



Epilation Forceps

17-850



Jameson Evans' Cilia Forceps

12cm.
17-855



Strabismus Scissors

- 17-860 Straight, Stainless Steel, Length: 12cm.
- 17-865 Curved, Stainless Steel, Length: 10.8cm.

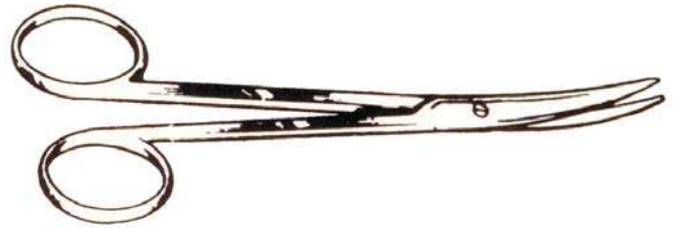

Iris Scissors

- 17-870 Straight, Stainless Steel, Length: 11.43cm.
- 17-875 Curved, Stainless Steel, Length: 10.16cm.



Strabismus Scissors

- 17-880 Straight, Stainless Steel, Length: 12cm.
- 17-885 Curved, Stainless Steel, Length: 10.8cm.



Excision Scissors

- 17-890 Straight, Stainless Steel, Length: 11.43cm.
- 17-895 Curved, Stainless Steel, Length: 11.43cm.



Distichiasis

The Clamp has been Designed to fit most Sizes of Eyelid, and will Hold Firmly the Papebral Margin the Cilia-Containing Strip of Tissue is Removed.

As Designed be Dr P.G.C Bedford, FRCVS, B.Vet.Med., D.V.Ophthol.

17-900

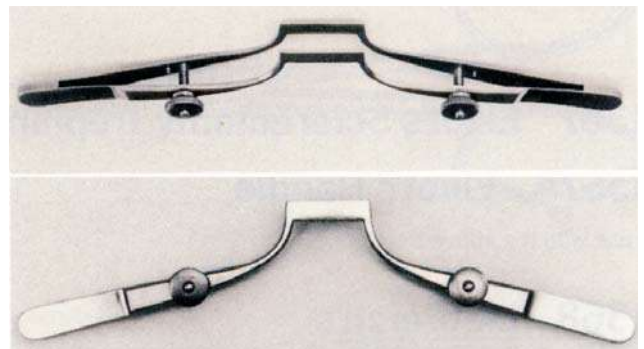

Hobdays Roaring Burr

Stainless Steel with Grooved Handle, Burr Diameter Approximately 10mm.
17-905



Harrison Butler's Lachrymal Cannula

Silver, Fine, Luer Lock.
17-930



Gallipot

Stainless Steel, Half Curl Edge, Outside Diameter 63mm.
17-935



Liebreich's Lachrymal Probes

Stainless Steel, Set of Four, Double Ended, 12.5cm.
17-940

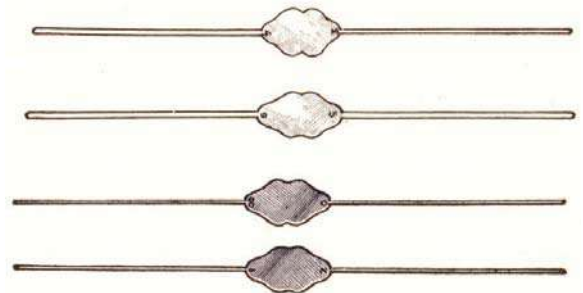

Beer's Cataract Needle

Slight Curved.
17-945

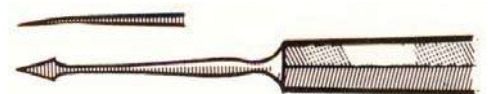

Desmarre's Entropion Forceps

17-950 9cm, Right
17-955 9cm, Left

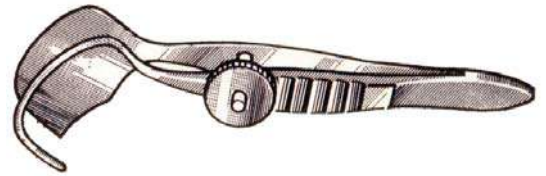

Enucleation Scissors

Round Points, Curved on Flap, 11.5cm.
17-960

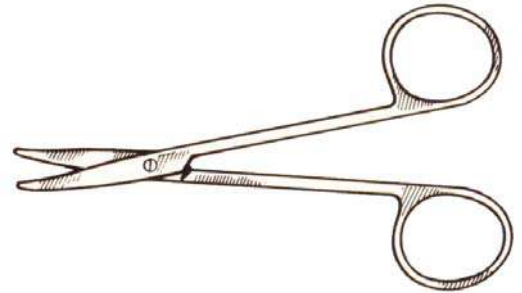

Conjunctival Scissors

Pooley's Fine Dissection.
17-965



Scissors

Sharp Points, Straight, Stainless Steel, 127mm.
17-970

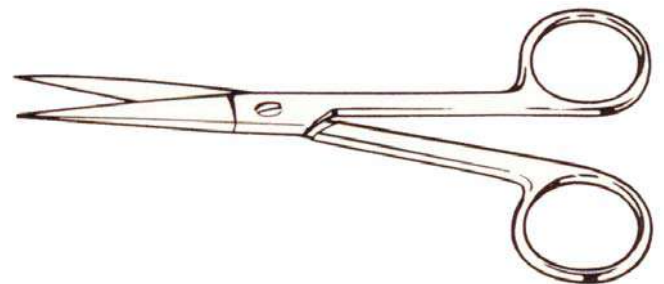

Halstead's Mosquito Artery Forceps

17-975 Box Joint, Straight, Stainless Steel, 127mm.
17-980 Box Joint, Curved, Stainless Steel, 127mm.

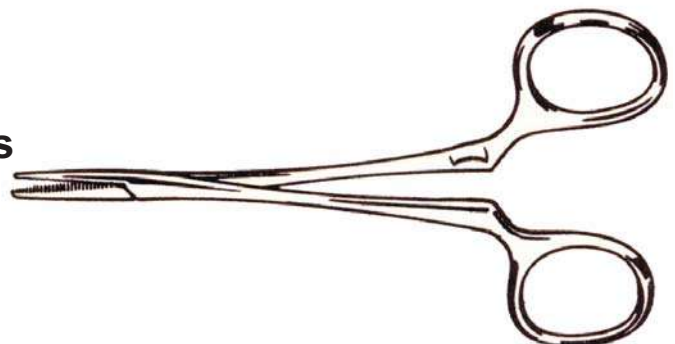

Eyelid Retractor

For Retracting the Eyelids by means of SUTURES, Thus Keeping the Operating site Clear of Encumbrance.
17-985

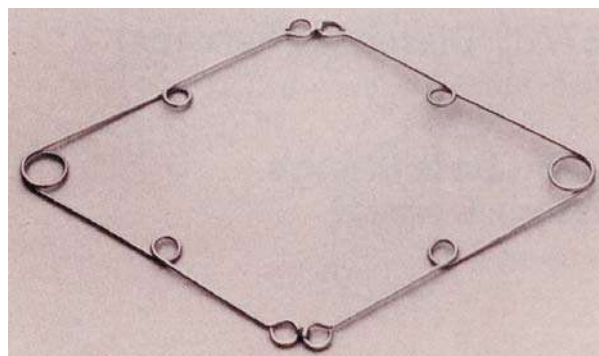

Paragon No.7 Knife Handle

To Hold Blades Numbers 10, 11, 12 and 15.
17-990



Allis's Tissue Forceps

Box Joint, Stainless Steel, 152mm.
17-995

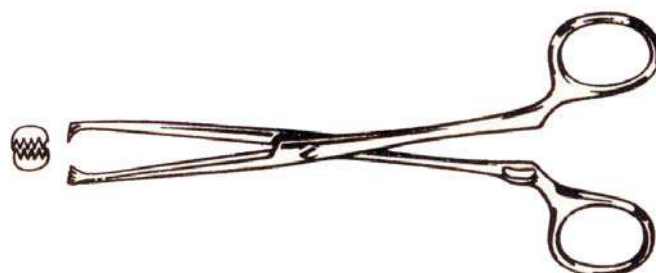

Rush Intramedullary Pins

S.Mo Stainless Steel.

Diameter 3.18mm		Diameter 3.38mm	
17-9025	2.5cm	17-9125	2.5cm
17-9032	3.2cm	17-9132	3.2cm
17-9038	3.8cm	17-9138	3.8cm
17-9044	4.4cm	17-9144	4.4cm
17-9051	5.1cm	17-9151	5.1cm
17-9057	5.7cm	17-9157	5.7cm
17-9064	6.4cm	17-9164	6.4cm
17-9070	7.0cm	17-9170	7.0cm
17-9076	7.6cm	17-9176	7.6cm
17-9083	8.3cm	17-9183	8.3cm
17-9089	8.9cm	17-9189	8.9cm
17-9095	9.5cm	17-9195	9.5cm
17-9102	10.2cm	17-9102	10.2cm



Castroviejo's Needle Holder

Spring Shanks without Catch, Straight,
Screw Joint, 140mm.
18-100

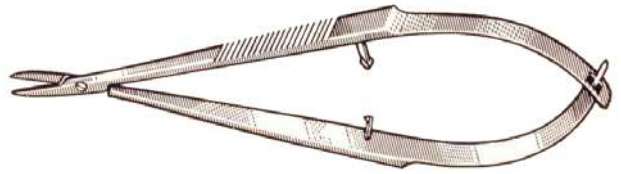

Castroviejo's Scissors, Corneal

Curved on Flat.
18-105



Arruga's Intra Capsule Forceps

Curved Tips, 95mm, Removal of residual Lens Material
During Extracapsular Extraction.
18-110



Barraquer's Corneal Forceps

1x2th, 75mm, All Round Forceps for Fine Work.
18-115

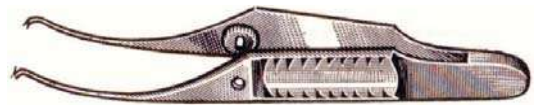

St. Martin's Corneal Suturing Forceps

1x2th, 85mm, All Round Forceps for Fine Work.
18-120



Snellen's Vectis

18-125 Blunt, Long Loop, Straight.
18-130 Blunt, Long Loop, Angled.
For Manipulation of the Lens During
Extracapsular Extraction.



Snellen's Vectis

Cross Action, Stainless Steel, 80mm, Superior Quality.
18-135



Luer Bone-Nibbling Forceps

18-140

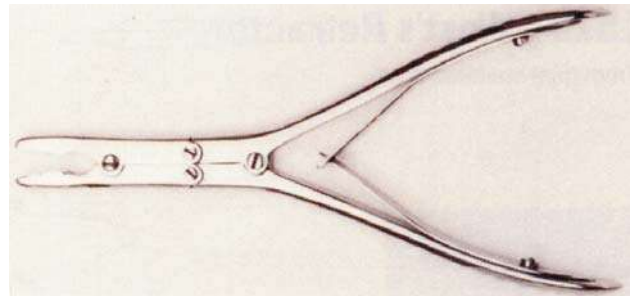

Luer Bone-Cutting Forceps

Screw Joint with Spring, Stainless Steel, Sizes as Under.

18-145 152mm

18-150 178mm



Wire Twister and Cutter

This Instrument Provides a Simple Means of Holding and Twisting Wires up to .0625in Diameter, Stainless Steel.

18-155



Wire Twister

18-160



Suture Wire Cutting Scissors

These Scissors have Specially Serrated Cutting Jaws Which Cut Stainless Steel Suture Wires of Small Diameter.

18-165

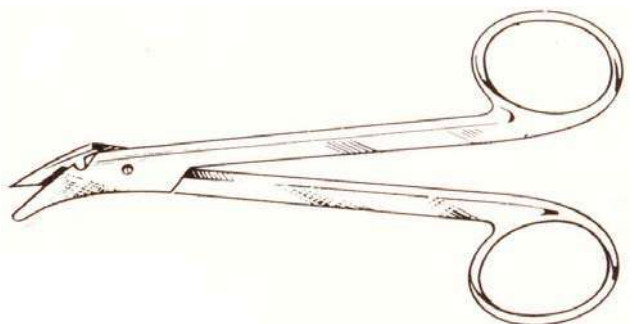

Small Osteotomes

18-170 4mm Length 15cm
18-175 6mm Length 15cm
18-180 8mm Length 15cm



Small Chisels

18-185 4mm Length 15cm
18-190 6mm Length 15cm
18-195 8mm Length 15cm



Small Gouges

18-200 4mm Length 15cm
18-205 6mm Length 15cm
18-210 8mm Length 15cm



Fergusson's or Lion Bone Holding Forceps

Stainless Steel, Firm Purchase is Obtained on the Bone with this Forcep.

18-215 152mm
18-220 203mm



Hey Groves Bone Holding Forceps

Stainless Steel, 203mm.
18-225

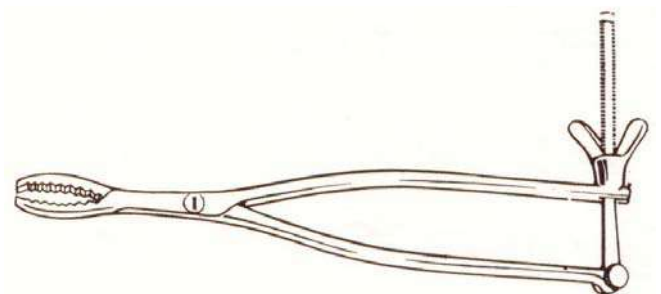

Cheatle's Sterilizer Forceps

27cm Screw Joint, Stainless Steel.
338-544-270

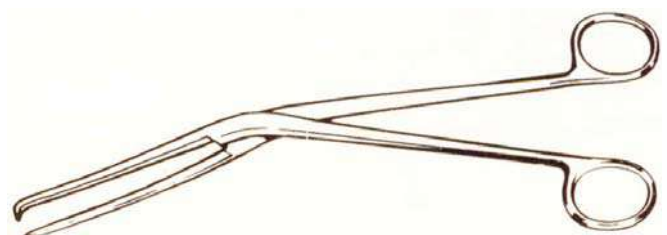

Volkmanns Cutette

18-230



Burn's Bone Holding Forceps

Overall Length: 18cm.

18-235



Orthopaedic Grasping Forceps

18-240 126mm

18-245 165mm

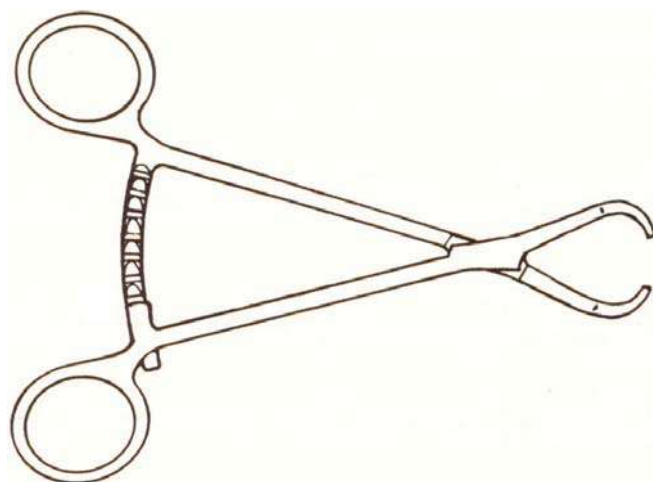

Sherman Bone Screws

S.Mo Stainless Steel, Coarse Thread.



3.6 Ø	2.8 Ø	Length
Cat #	Cat #	MM
18-2010	18-2110	10
18-2013	18-2113	13
18-2016	18-2116	16
18-2019	18-2119	19
18-2022	18-2122	22
18-2025	18-2125	25
18-2028	18-2128	28
18-2031	18-2131	31
18-2034	18-2134	34
18-2037	18-2137	37
18-2040		40
18-2043		43
18-2046		46
18-2050		50
18-2056		56

When Ordering, Please Quote Length and Diameter, Together with Reference Number.

Twist Drills Bits

Stainless Steel, Length: 127mm.

18-2213	1.3mm
18-2216	1.6mm
18-2220	2.0mm
18-2224	2.4mm
18-2228	2.8mm
18-2232	3.2mm
18-2236	3.6mm
18-2240	4.0mm
18-2248	4.8mm



Orthopaedic Screw Drivers

With Holding Sleeve, Holds the Screw Rigid to Start then Separates to Drive the Screw Home.

- 18-250 To Take 3.6mm Diameter Screws.
- 18-255 To Take 2.8mm Diameter Screws.
- 18-260 For Fingerplate Screws, Length: 165mm. (Without Holding Sleeve).

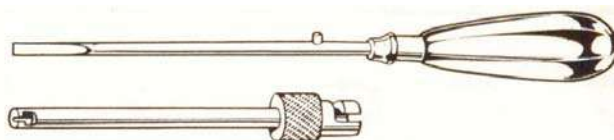

Ruler

Made from Stainless Steel, The Ruler is ideal for Measuring Intramedullary Pin and Twist Drill Diameters, Length: 152mm.

18-265



Hacksaw

Complete Hacksaw with Blades for Cutting Bone Pins, Metal Frame, Length: 25cm, Depth of Bow: 5cm, Blade Length: 15cm.

18-268

Spare Blades for Hacksaw (Pack of Ten)

18-270

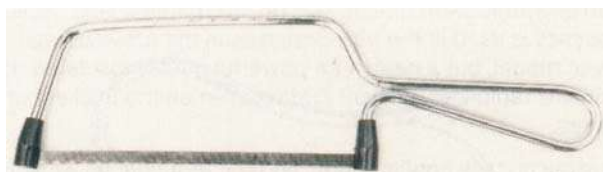

Plaster Cutter

Length: 24cm.
18-275

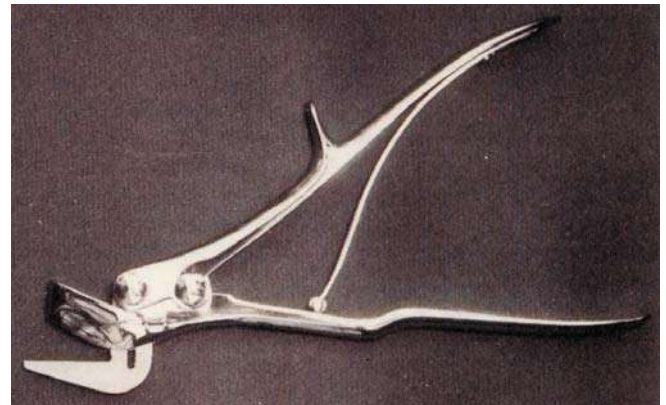

Swiss Pattern Aural Forceps

18-280

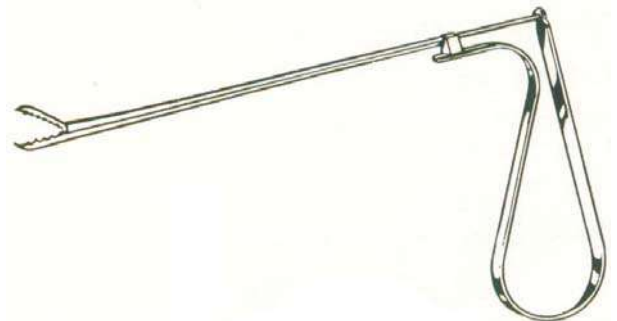

Bohler's Plaster Shears

Stainless Steel, Length: 25.5cm.
18-285

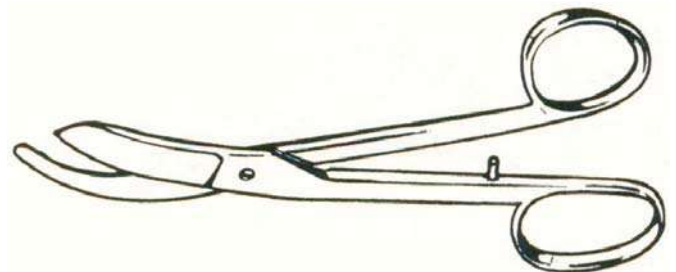

Matthews' Aural Forceps

18-290 Crocodile Pattern, Stainless Steel, Short 90mm.
18-295 Veterinary Pattern, Length: 140mm.

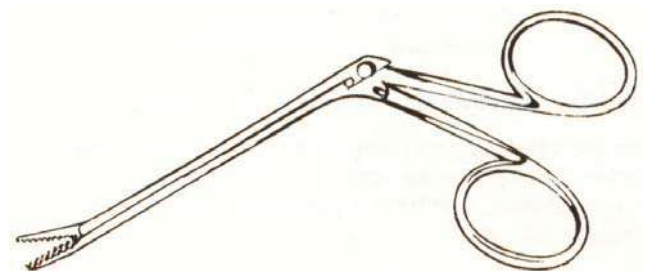

Jackson's Oesophageal Forceps

Stainless Steel, 60cm Long.
18-300

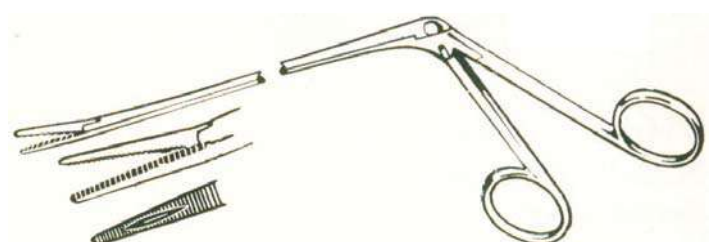

Bone Pin Grip

The Bone Pin Grip can be Used for the Extraction of Steinman Pins, in Open Pinning Operations, and in Particular the Femur.

18-305

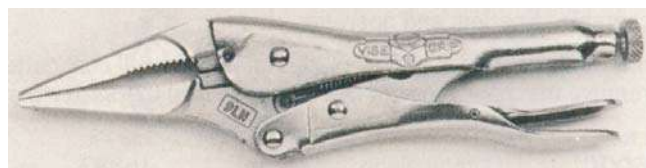

Veterinary Otoscope Set

Contents

Slit Otoscope Head Complete with Swivel Lens, Closed Speculum 57 x 4mm, Same 65 x 6mm, Same 90 x 7mm, 1 Replacement Bulb (2.5 Volts), Standard N Battery Handle, In Compact Zipper Case.

18-310



Veterinary Diagnostic Set

Contents

Miroflex W2 Ophthalmoscope, Slit Otoscope Head Complete with Swivel Loupe, Closed Speculum 57 x 4mm, Closed Speculum 65 x 6mm, Closed Speculum 90 x 7mm, 1 Replacement Bulb Each (2.5 Volts), Standard N Battery Handle, In Compact Zipper Case.

18-315



Standard N Battery Handle

The Heine Automatic Connector

For decades, the Sign for modern Diagnostic Instruments of the Highest Quality.

Instruments can be Instantly Attached to, or Detached from their Handle with 'Fingertip' ease.

Good Electrical Contact is Assured.

The Instrument is Positively Located and cannot Twist in its Mounting.

18-320



Large Veterinary Diagnostic Set

Contents

Miroflex W2 Ophthalmoscope, Slit Otoscope Head Complete with Loupe, 1 Set = 5 Pieces, Veterinary Specula (Sanalon S), 1 Transparent Pack with 10 Disposable Specula, 4mm Diameter Adaptor for Above, Closed Speculum 57 x 4mm, Same 65 x 6mm Same 90 x 7mm, Slit Speculum 65 x 6mm, Same 900 x 7mm, Veterinary-Tubus, 150 x 10mm, Veterinary Spreadable Speculu 1 Replacement Bulb each 2.5 Volt. Standard N Battery Handle, In Leatherette Case with Plastic Insert.

18-325

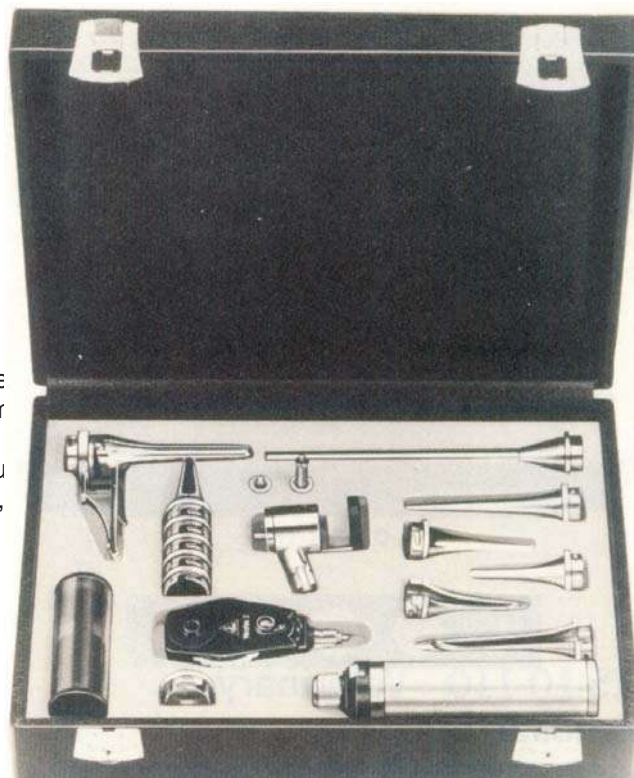

Sterilizing Drums

Stainless Steel.

338-010-006 24 x 12cm

338-012-008 24 x 24cm



Plastic Instrument Tray

With 3 Small and 1 Large Division.

Size Overall: 270 x 178 x 30mm

18-330



Instrument Trays Without Covers

Stainless Steel,

338-262-016 350 x 300 x 51mm

338-263-017 400 x 350 x 51 mm

338-264-018 450 x 300 x 51mm

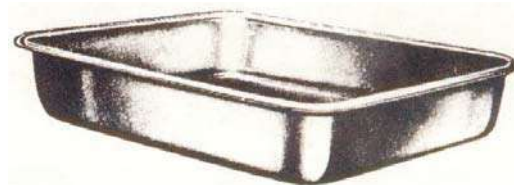

Kidney Trays

Stainless Steel,

338-306-001 150mm

338-307-002 200mm

338-308-003 240mm

338-309-005 300mm

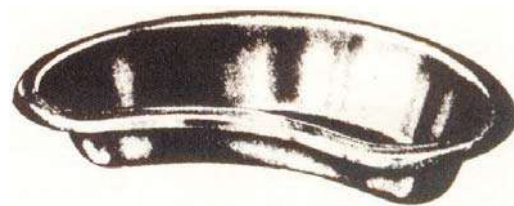

Lotion Bowls

Stainless Steel.

338-316-002 100 mm

338-318-004 150 mm

338-319-005 200 mm

338-320-006 250 mm

338-321-007 300 mm



Bolus & Tablet Guns

Magnet Gun

Curved - CP

19-100 54 x 26mm

19-105 54 x 38mm



Farmer Blling Gun

(Brass/NP)

19-110 5/8"



Balling Gun Plastic Head

19-115 5/8"



Calf Balling Gun

(Brass/NP)

19-120 5/8"



Balling Gun Rubber Head

(Brass/NP)

19-125 5/8"



Bolus & Tablet Guns

Balling Gun Rubber Head

(Brass/NP)

19-130 5/8"



Magnet/Bolus Applicator

Curved Rubber Haed - CP

19-135



Magnet/Bolus Applicator

Curved Rubber Haed - CP

19-140



Magnet Inserter

Plastic

19-145



Calf Balling Gun

(Brass/NP)

19-150 5/8"



Bolus & Tablet Guns

Magnet/Bolus Applicator Holds

5 - Bolus (Brass/NP)

19-155



Magnet Gun Curved 54cm

(CP)

19-160



Magnet/Bolus Applicator

Curved Rubber Head. SEMI AUTO (CP)

19-165



Castrator Forceps

Castration Forceps

(SS)

20-100 23cm



Castration Forceps

(SS)

20-105 23cm



Castrator Forceps

Newberry Castration Knife

(SS)

20-110



Castration Knife(SS)

(SS)

20-115 (Double Blade)



Castration Knife(SS)

(SS)

20-120 (Triple Blade)



Elastrator Rubber Ring Applicator

(SS)

20-125



Elastrator Rubber Ring Applicator

(Aluminum)

20-130



Gastrator Forceps

Elastrator Rubber Ring Applicator

(Aluminum)

20-135



Grooved Wires-Elastrator Rubber Ring Applicator

(CP)

20-140



Elastrator Rubber Ring Applicator

(SS)

20-145



Elastrator Rubber Ring Applicator

(Plastic)

20-150



Verboczy Emasculator

Fixed Clamping Part, Triple Crush (SS)

20-155 23cm



Gastrator Forceps

Verboczy Emasculator

Fixed Clamping Part, Triple Crush (SS)

20-160 30cm



Verboczy Emasculator

Fixed Clamping Part, Triple Crush (SS)

STR	CVD
20-200 27cm	20-215 27cm
20-205 23cm	20-220 23cm
20-210 19cm	20-225 19cm



Reimers Emasculator

(SS)

20-250 33cm



Reimers Emasculator with Cutting Device

(SS)

20-255 31cm



Sand Emasculator

(SS)

20-260 31cm



Dehorning Instruments

Growing Tooth Forceps

(SS)

21-100 28cm



Gowing Tooth Forceps

(SS)

21-105 28cm



Reinhard Tooth Forceps

(SS)

21-110 43cm



Tooth Rasp Fixed Head

(SS)

21-115 28"



Dental Float

(CP)

21-120 20"

21-121 26"



Dehorning Instruments

Replacement Blade

(CS)

21-125



Universal Dental Float Hinged Blade

(CP)

21-130 20"

21-135 26"



Replacement Blade

(CS)

21-140



Dental Elevator

Aluminum Handle (SS)

21-145



Bayer Mouth Wedge for Cattle & Horse

(SS)

21-150



Dehorning Instruments

Schulze Mouth Gag for Cattle & Horse

(SS)

21-155



Schoupe

(SS)

21-160 2-1/3"



Holborn Mouth Gag for Horse

W/Brown Leather Straps (SS)

21-165



Mouth Gag For Dogs

(SS)

21-170



Barne Dehorner Wood Handle

(CP)

21-175 12"



Dehorning Instruments

Barne Dehorner Heavy Duty

Black Steel (CP)

21-180 12"



Dehorner Polish

Heavy Duty (CP)

21-185 17"



Dehorner Heavy

Black Steel Curved Handle (CP)

21-190



Wire Saw

Set 1 Pair

21-195 4"



Drenchers

Uterine Pump

Complete Set with Box

22-100 28mm Dia



Drench Pump

(Brass/NP)

22-105 39cm



Drinking Nipples

Pig Drinking Nipples

(All Size Available)

23-100



Pig Drinking Nipples

(All Size Available)

23-105



Pig Drinking Nipples

(All Size Available)

23-110



Pig Drinking Nipples

(All Size Available)

23-115



Drinking Nipples

Pig Drinking Nipples

(All Size Available)

23-120



Pig Drinking Nipples

(All Size Available)

23-125



Ear Marking & Tagging

Ear Notcher

Cloverleaf Cut Shape

24-100 23cm Length



Ear Notcher

Rounded Shape (SS)

24-105 15cm



Ear Notcher

Small V-Cut Shape (SS)

24-110 15cm Length



Ear Marking & Tagging

Ear Notcher

Rectangular Shape (SS)

24-115 15cm Length



Ear Notcher

V-Cut Shape (SS)

24-120 15cm Length



Ear Notcher Small

V-Cut (Aluminum)

24-125



Ear Notcher

M-Cut Shape

24-130 15cm Length



Standard Tattoo Plair

Aluminum (4-Digits)

24-135 3/8"



Ear Marking & Tagging

Tattoo

N/A

24-140 3/8"
24-145 5/16"



Tattoo Plier

Aluminum (6-Digits)

24-150 7mm



Tattoo

N/A

24-155 7mm



Tag Hanger

N/A

24-160



Ear Tagging Plier

Aluminum

24-165



Ear Marking & Tagging

Ear Tagging Plier

Aluminum

24-170



Tag Hanger

N/A

24-175



Ear Tag Applicator

Aluminum (Premier "X" Tag)

24-180



Ear Notcher

Triangular Shape (SS) Large

24-185



Ear Notcher Oval Cut

(SS)

24-190



Ear Marking & Tagging

Standard Tatoo Plair

Aluminum (4-Digits)

24-195 3/8"



Shoulder Tatoo

Galvanized

24-200



Ear Notcher Heavy

(SS)

24-205



Freeze Branding

(0-9 Digit) Aluminum

24-210



Burdiaao

N/A

24-215



Ear Marking & Tagging

Shoulder Tatoo

(SS)

24-220



Ink Pad with Grip

Without Pad (SS)

24-225



Tatoo

N/A

24-230



Ear syring

Ear Syring

Brass/NP (All Size Available)

24-235



Obstetrical - Embryotomy

Thoroughbred Vaginal Speculum

(SS)

25-100



Obstetrical - Embryotomy

Tube Speculum

30cm - 3m Dia (Brass/NP)

25-105



Frick Speculum

20" 1-1/4 Dia (Brass/NP)

25-110



Wound Needle

(Galvanized) Small

25-115



Wound Needle

(Galvanized) Medium

25-120



Wound Needle

(Galvanized) Large

25-125



Embryotomy

Hodbay OB Forceps

(SS)

26-100 20cm



Pig Obstetrical Forceps

(SS)

26-105 48cm

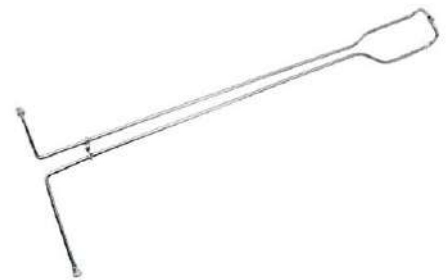

Witt Obstetric Forceps

(SS)

26-110 52mm



Obstetric Hook

(SS)

26-115 34cm

26-120 54cm

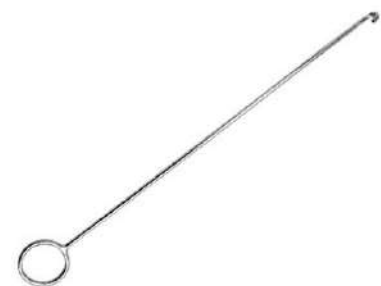

Calving Chain

Adjustable Handles (CP)

26-125 150cm



Embryotomy

Obstetric Chain

Middle Oval Ring (SS)

26-130 80cm
26-135 100cm



Obstetric Chain Handle

Also Available with Rubber Grip (CP)

26-140



Lambing Instrument

N/A

26-145 50cm

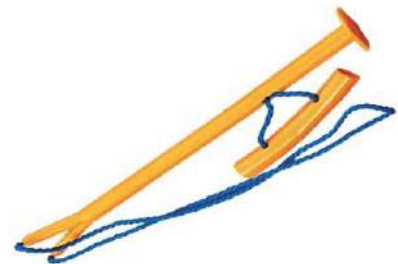

Dr. Buhner Needle

(SS)

26-150



Dr. Buhner Needle

(SS)

26-155



Embryotomy

Dr. Buhner Needle

(SS)

26-160 30cm



Calf Head Snare

Adjustable OB Loop Steel Cable

26-165



Embryotome

with Insertion Wire & Cleaning Brush (SS)

26-170



Calf Puller Standard Complete

(CP)

26-175



Linde Embryotome Knife

(SS)

26-180 5"



Embryotomy

Uteri Support

N/A

26-185



Prolapse Uteri Support Leather

N/A

26-190



Uterine Forceps

(SS)

26-195



Milking Whiskis

Milking Tube with Olive

Dia RECORD (SS)

27-100 80 x 2mm



Milking Tube with Olive

Dia RECORD (SS)

27-105 80 x 2mm



Milking Whiskis

Teat Slitter Adjustable

(SS) Double Blade

27-110



Milking Whish

(SS)

27-115



Mole Trape

Mouse/Rate Trape

Galvanized

28-100



Mole Trap with Chain

Galvanized

28-105



Mole Trap with Handle

Galvanized

28-110



Pig Holders

Pig Holder

Self Locking (CP)

29-100



Pig Holder

Self Locking (CP)

29-105



Pig Holder Strong

Small Aluminum Handle

29-110



Pig Holder

Small Rubber Handle

29-115



Pig Holder

2-*Rubber Grips (CP)

29-120



Pig Holders

Pig Holder

Small Rubber Grip (CP)

29-125



Pig Holder

Small Umbrella Handle

29-130



Pig Holder Long

Self Locking (CP)

29-135



Hog Catcher

Self Locking (CS)

29-140

Restraining

Hobble Black Leather with Heavy Chain

N/A

30-100



Hobble Nylon with Strips & Leather Reinforcement

N/A

30-105



Scraper Manure, Galvanized

W/Changeable Rubber Blade

30-110



Sheperd Stovel Pointed

with Catch Hook (SS)

30-115



Sheperd Stovel Rounded

with Catch Hook (SS)

30-120



Restraining

Hoof Clamp

(Aluminum)

30-125



Milk Anti Sucker

(Galvanized)

30-130



Milk Anti Sucker

Large

30-135



Milk Anti Sucker

Medium

30-140



Milk Anti Sucker

Small

30-145



Restraining

Pig Muzzle with Neck Starp

N/A

30-150



Bull Holder Long Handle

with Rubber Grip in any Color (CP)

30-155



Applicator for Milk Anti Sucker

Red Colored (CS)

30-160



Milk Anti Sucker with Spikes

Aluminum

30-165



Milk Sucking Preventer

Aluminum

30-170



Restraining

Milk Anti Sucker with Spikes Adjustable Spring

(Aluminum)

30-175



Pig Nose Ring

N/A

30-180 30mm



Bull Nose Ring H Model

Dia (Brass)

30-185 55mm



Bull Nose Ring S Shaped

(SS)

30-190 55mm



Bull Nose Ring Standard

N/A

30-195 55mm



Restraining

Bull Nose Ring Standard

Dia (Brass)

30-200 55mm



Bull Leader Heavy Model

(CP)

30-205



Bull Holder with Coiled Spring

(SS)

30-210 17cm



Cattle Leader

Finish Brass

30-215 3-3/4"



Bull Holder

(CP)

30-220 11cm



Restraining

Applicator for Slandered Rings

(CS)

30-225 5"



Applicator for Standard Rings

(SS)

30-230



Applicator for S-Shaped Rings

(SS)

30-235



Applicator for Pig Nose Rings

(CP)

30-240



Bull Nose Punch

(SS)

30-245 26.50cm



Restraining

Bull Holder VE-ME

Design for One Hand Use (SS)

30-250



Applicator for Staples

(CP)

30-255



Applicator for Staples

(Aluminum)

30-260



Bull Leader

with Hook (CP)

30-265



Bull Leader

(CP) with Hook & Chain

30-270



Restraining

Bull Leader

(CP)
30-275 without Hook
30-280 with Chain



Bull Leader

With Hook (CP)
30-285



Bull Leader

(CP)
30-290 without Hook
30-295 without Chain



Bull Leader

(SS) without Hook
30-300



Bull Leader

With Chain (SS)
30-305



Restraining

Fettering Chain

Adjustable Length (Galvanized)

30-310



Anti Kick Bar Galvanized

(1650-1700 grams)

30-315



Replacement Spring

N/A

30-320



Pig Nose Straple

(CS) All size Available

30-325 20mm

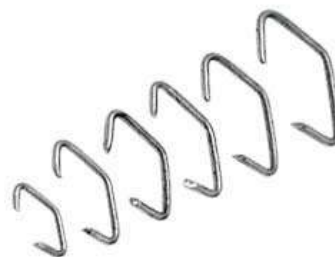

Crook Head Leg Model

(Aluminum)

30-330



Restraining

Sheperd Crook Neck Model

(Aluminum)

30-335 95cm
30-340 115cm



Sheperd Crook Leg Model

(Aluminum)

30-345 95cm
30-350 115cm



Sheperd Crook Dual Purpose Model

(Aluminum)

30-355 134cm

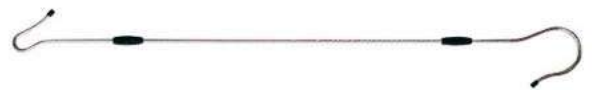

Teat Instruments

McLean Teat Knife

(SS)

31-100



McLean Teat Knife

(SS)

31-105



Teat Instruments

McLean Teat Knife

(SS)

31-110



Grove Probe Director

(SS)

31-115 5"



Teat Slitter Adjustable

(SS)

31-120 Single Blade
31-125 Double Blade



Teat Slitter Scissor

(SS)

31-130 6"



Teat Tumor Extractor

(SS)

31-135 Dia 3.5mm
31-140 Dia 4mm



Teat Instruments

Teat Lancet

(SS)

31-145 4mm

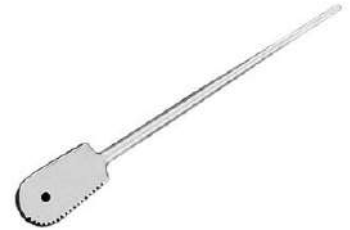

Teat Dialator

(SS)

31-150 5.5"



Trocars

Trocar & Canula

9cm Length (SS)

32-100 5mm



Trocar & Canula

12cm Length (SS)

32-105 7mm



Trocar & Canula

9cm Length (SS)

33-110 5mm



Trocars

Trocar & Canula

12cm Length (SS)

33-115 7mm



Trocar & Canula

15cm Length (SS)

33-120 10mm



Dog Nail Nipper

(SS)

34-100



Dog Nail Nipper

with Rubber Grip (SS)

34-105



Cat Nail Nipper

Red Colored (SS)

34-110



Cat Nail Nipper

Red Colored Rubber Grip (SS)

34-115



Cat Nail Nipper

Deferent Colored Plastic Grip (SS)

34-120



Sheep Hair Clipper

(CS)(CP)

34-125



Horse Hair Clipper

N/A

34-130



Pig Nail Nipper

Red Colored (SS)

34-135



Nail Nipper

(SS)

34-140



Horse Shoe

(CS)

34-145



Standard Horse Shoe

Pair (CS)

34-150



Horse Shoe with Trailer

(CS)

34-155



Horse Shoe

(CS)

34-160



Horse Shoe

(CS)

34-165



Horse Shoe

(CS)

34-170



Horse Shoe

Pair (CS)

34-175



Horse Shoe

(CS)

34-180



Horse Shoe

(CS)

34-185



Spikes for Horse Shoe

(CS)

34-190

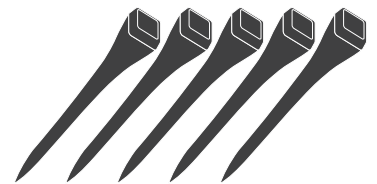

Thumb speculum for Diagnosis
15-100



Mouth Gag
15-110

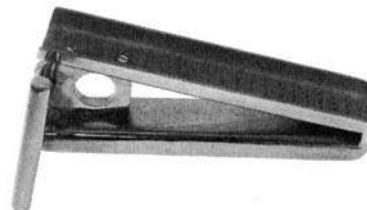

Mouth Gag "COMET"
15-115



Mouth Gag
15-120



Head Lamp, Moveable, Halogen, With Battery Box
15-125





Chisel, Complete
15-130

Chisel Top For Chisel, Only
15-135

Pestle for Chisel, Only
15-140

Bite Plate, Pair, Only
15-145

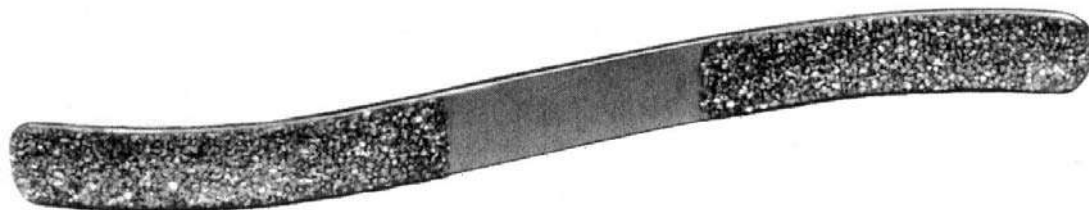

S-Shaped Hand RASP, Length 30cm (For Shortening of Canini and Molars)
15-150

Bite Bar, Only
15-155



Full Mouth Gag Modified, Complete
15-160



Pistol Grip for Hand RASP, Short, Length 30cm
15-165



Pistol Grip for Hand RASP, Long, Length 42cm
15-170

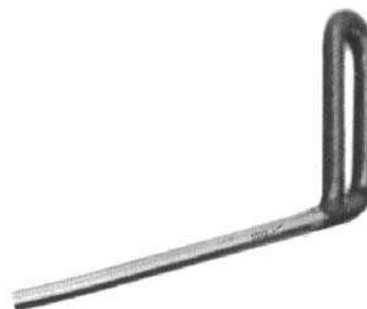

RASP Top, Angled Up, T/C Covered
15-175

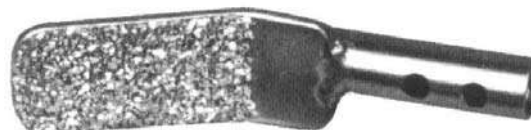

RASP Top, Straight, T/C Covered
15-180

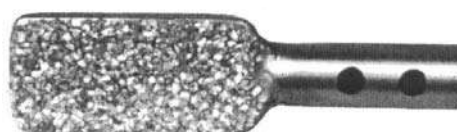

RASP Top, Angled Down, T/C Covered
15-185

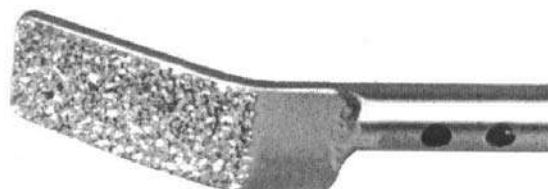

Tooth-RASP-SET
20-150

Consisting of:
15-165 / 15-170 / 15-175 / 15-180 / 15-185

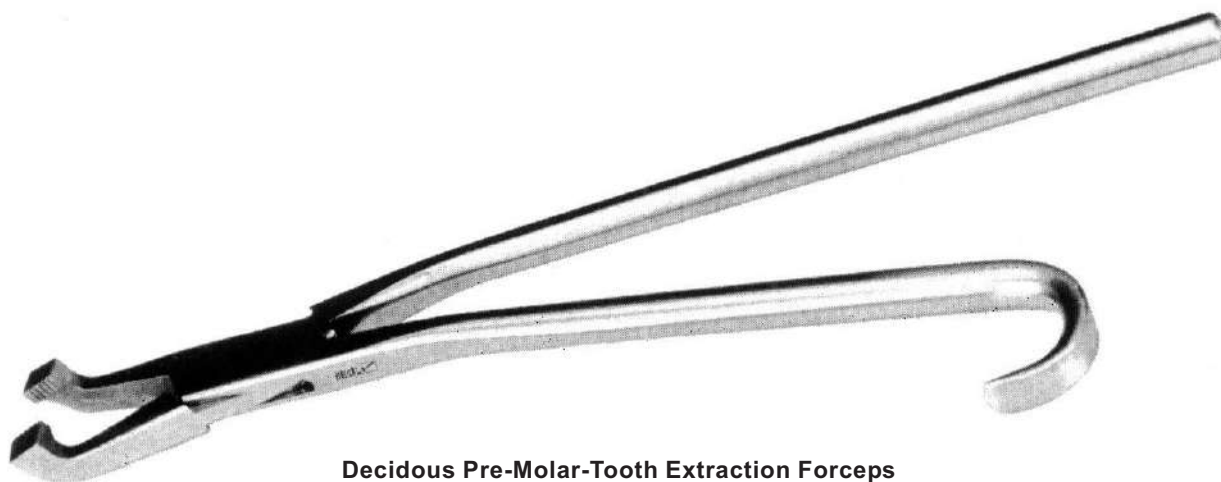

Deciduous Pre-Molar-Tooth Extraction Forceps
15-190



Extraction Forceps
15-195

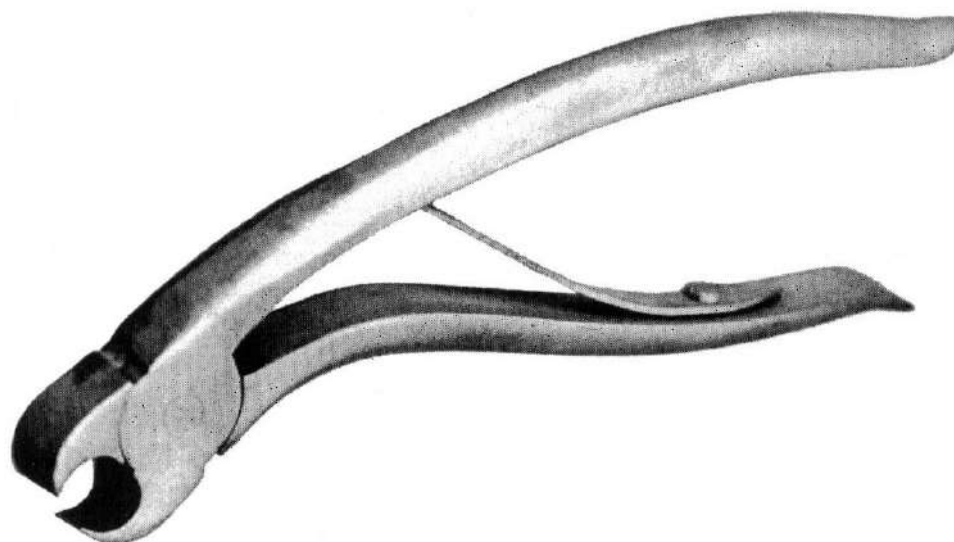

Deciduous-Incisor-Tooth Extraction Forceps
15-200

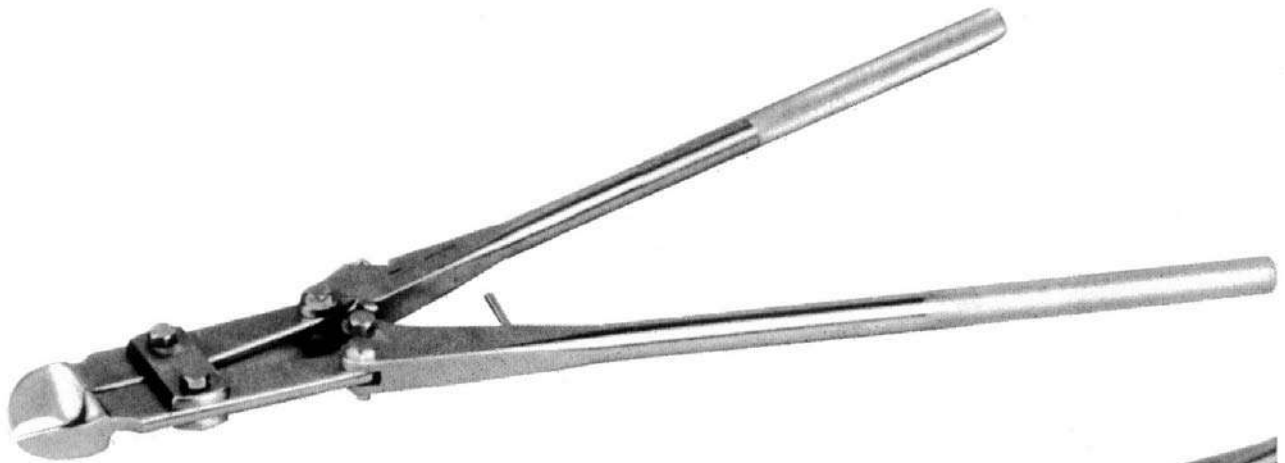

Tooth Cutter, Straight, Length 56cm
15-205

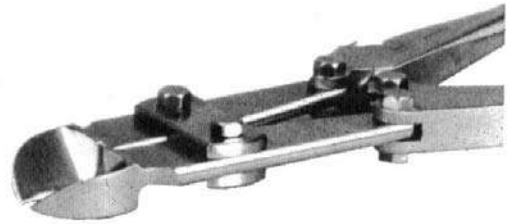

Tooth Cutter, Angled, Length 56cm
15-210

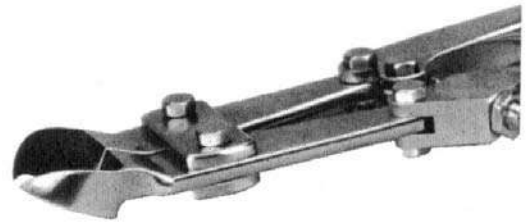

Universal Extraction Forceps
15-215

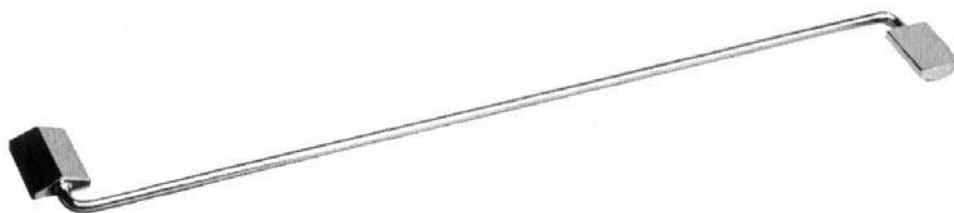
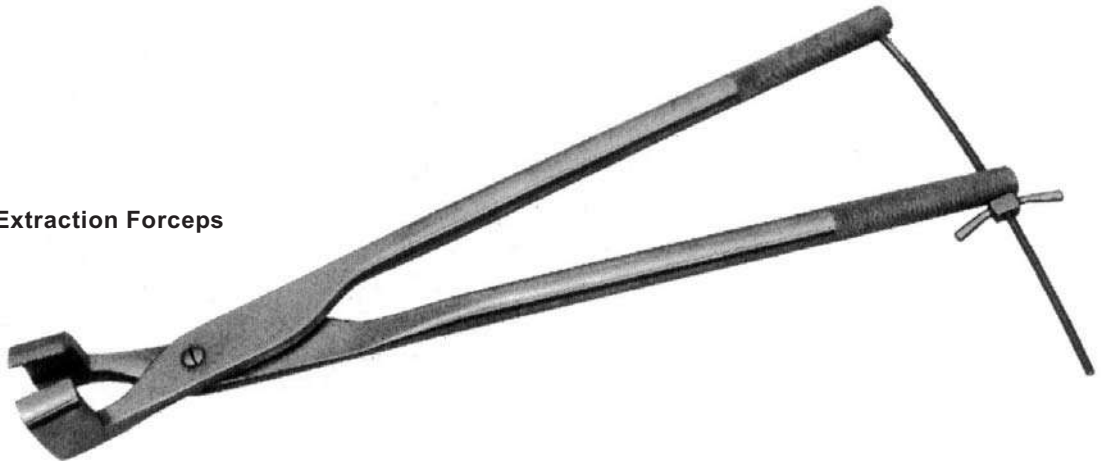

Hypomochleon, Fig-1 : 56cm
15-220

Hypomochleon, Fig-2 : 56cm
15-225

**Top for Wolf Tooth Extractor Fig-1
15-230**

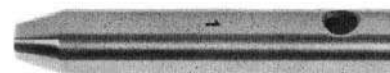

**Top for Wolf Tooth Extractor Fig-2
15-235**

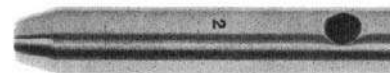

**Top for Wolf Tooth Extractor Fig-3
15-240**



**Top for Wolf Tooth Extractor Fig-4
15-245**

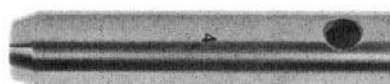

**Ejector for Wolf Tooth Extractor
15-250**



**Handle for Wolf Tooth Extractor
15-255**

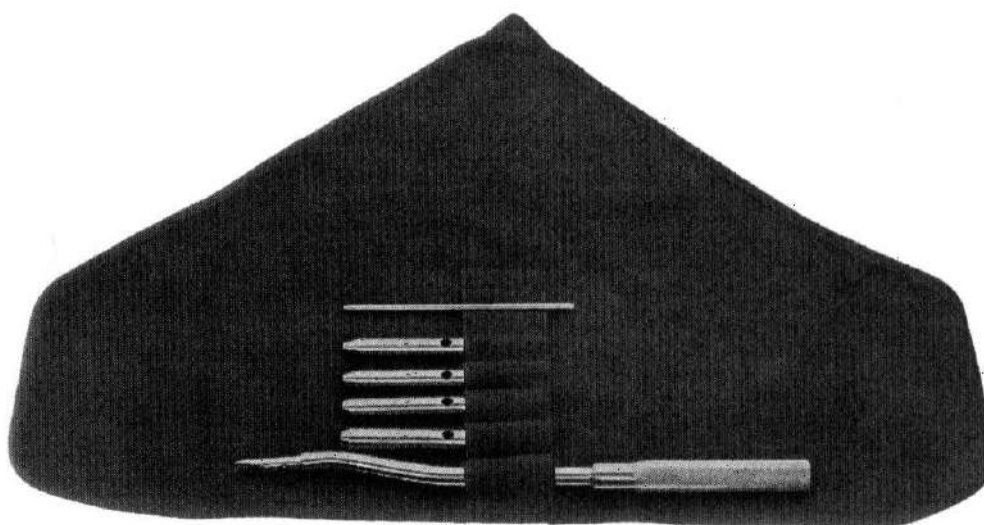

**Wolf Tooth Extractor-Set, Complete
With 4 Tops, in Canvas Roll
15-260**

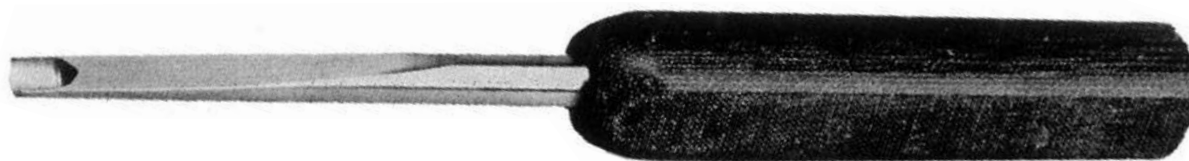

**Root Elevator, Length 22cm
15-265**

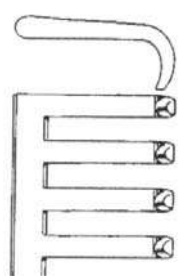

Blunt

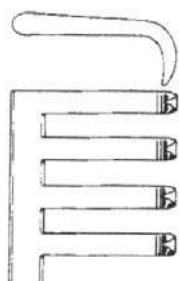

Sharp

**Weitlaner Retractor, Sharp, Length 13cm
15-270**

**Weitlaner Retractor, Blunt, Length 13cm
15-275**

**Weitlaner. sharp. 16.5 cm. 3 X 4 pr.. 16 mm deep
100-481-09**

**Weitlaner. Blunt. 16.5 cm. 3 X 4 pr.. 16 mm deep
100-481-09**



**Wolf Root Elevator, Length 25cm
15-280**

Osteotom, Strong, Length 20cm
100-635-12 12mm
100-635-20 20mm

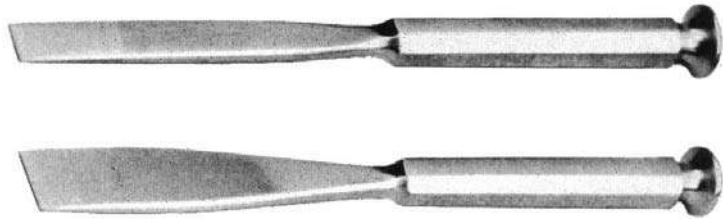

Hammer 450 Grams
100-602-50



Crown Cutter Alone, Ø 19mm
15-285



Crown Cutter Alone, Ø 22mm
15-290



Crown Cutter Alone, Ø 25mm
15-295



Trepanation Set With 2 Crown Cutters,
Ø 19mm and Ø 22mm
15-300



Trepanation Set With 3 Crown Cutters,
Ø 19mm and Ø 22mm, Ø 25mm
15-305

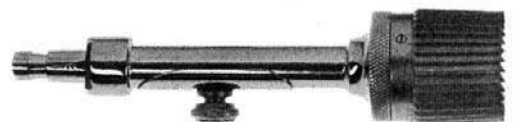

Handle Alone for Trepan
15-310



Periosteal Elevator Medium Straight Round Edge 14mm Blade Width
100-725-14



15-330
Set Tooth Punch, Straight, 20cm
15-320 / 15-325



Tooth Punch, Straight, 20cm
15-320

Tooth Punch, Curved, 20cm
15-325



Gouges Set, Strong, Legth 18cm, 6-14mm (15-335 to 15-355)
15-400

Gouge, Strong, Length 18cm

15-335	6mm
15-340	8mm
15-345	10mm
15-350	12mm
15-355	14mm



Syringe for Mouth Irrigation
15-405

Bone Screws Mini Screws

1.5, 2.0, 2.7 mm



Dia of thread	1.5 mm	2.0 mm	2.7 mm
Dia of core	1.0 mm	1.3 mm	1.9 mm
Dia of head	3.0 mm	4.0 mm	5.0 mm
Length			
6 mm	126-015-06	126-020-06	126-027-06
7 mm	126-015-07		
8 mm	126-015-08	126-020-08	126-027-08
9 mm	126-015-09		
10 mm	126-015-10	126-020-10	126-027-10
11 mm	126-015-11		
12 mm	126-015-12	126-020-12	126-027-12
14 mm	126-015-14	126-020-14	126-027-14
16 mm	126-015-16	126-020-16	126-027-16
18 mm	126-015-18	126-020-18	126-027-18
20 mm	126-015-20	126-020-20	126-027-20
22 mm		126-020-22	126-027-22
24 mm		126-020-24	126-027-24
26 mm			126-027-26
28 mm			126-027-28
30 mm			126-027-30
32 mm			126-027-32
34 mm			126-027-34
36 mm			126-027-36
38 mm			126-027-38
40 mm			126-027-40



126-107-07 Washer

Bone Screws Mini Screws

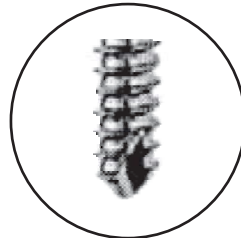

Self Cutting Screws, Tapping Not Needed.

1.5, 2.0, 2.7 mm



Dia of thread	1.5 mm	2.0 mm	2.7 mm
Dia of core	1.0 mm	1.3 mm	1.9 mm
Dia of head	3.0 mm	4.0 mm	5.0 mm
Length			
6 mm	15-4106	15-4206	15-4276
7 mm	15-4107		
8 mm	15-4108	15-4208	15-4278
9 mm	15-4109		
10 mm	15-4110	15-4210	15-4210
11 mm	15-4111		
12 mm	15-4112	15-4212	15-4212
14 mm	15-4114	15-4214	15-4214
16 mm	15-4116	15-4216	15-4216
18 mm	15-4118	15-4218	15-4218
20 mm	15-4120	15-4220	15-4220
22 mm		15-4222	15-4222
24 mm		15-4224	15-4224
26 mm			15-4226
28 mm			15-4228
30 mm			15-4230
32 mm			15-4232
34 mm			15-4234
36 mm			15-4236
38 mm			15-4238
40 mm			15-4240

Bone Screws

Small screws with Spherical Head and small Hexagonal Socket width across flats 2.5 mm



Dia of thread	3.5 mm	3.5 mm	4.0 mm	4.0 mm
Pitch	1.25 mm	1.75 mm	1.75 mm	1.75 mm
Dia of core	2.4 mm	1.9 mm	1.9 mm	1.9 mm
Dia of shaft			2.3 mm	
Dia of head	6.0 mm	6.0 mm	6.0 mm	6.0 mm
Length				
10 mm	125-035-10	125-080-10	125-092-10	125-105-10
12 mm	125-035-12	125-080-12	125-092-12	125-105-12
14 mm	125-035-14	125-080-14	125-092-14	125-105-14
16 mm	125-035-16	125-080-16	125-092-16	125-105-16
18 mm	125-035-18	125-080-18	125-092-18	125-105-18
20 mm	125-035-20	125-080-20	125-092-20	125-105-20
22 mm	125-035-22	125-080-22	125-092-22	125-105-22
24 mm	125-035-24	125-080-24	125-092-24	125-105-24
26 mm	125-035-26	125-080-26	125-092-26	125-105-26
28 mm	125-035-28	125-080-28	125-092-28	125-105-28
30 mm	125-035-30	125-080-30	125-092-30	125-105-30
32 mm	125-035-32	125-080-32	125-092-32	125-105-32
34 mm	125-035-34	125-080-34		
35 mm			125-092-35	125-105-35
36 mm	125-035-36	125-080-36		
38 mm	125-035-38	125-080-38		
40 mm	125-035-40	125-080-40	125-092-40	125-105-40
42 mm	125-035-42			
45 mm	125-035-45	125-080-45	125-092-45	125-105-45
48 mm	125-035-48			
50 mm	125-035-50	125-080-50	125-092-50	125-105-50
55 mm	125-035-55	125-080-55	125-092-55	125-105-55
60 mm	125-035-60	125-080-60	125-092-60	125-105-60
65 mm	125-035-65			
70 mm	125-035-70			
75 mm	125-035-75			
80 mm	125-035-80			
85 mm	125-035-85	125-080-85	125-092-85	125-105-85
90 mm	125-035-90	125-080-90	125-092-90	125-105-90
95 mm	125-035-91	125-080-91	125-092-91	125-105-91
100 mm	125-035-92	125-080-92	125-092-92	125-105-92
105 mm	125-035-93	125-080-93	125-092-93	125-105-93
110 mm	125-035-94	125-080-94	125-092-94	125-105-94



125-107-07 Washer for Navicular Spongiosa Screws Ø 7 mm

Bone Screws Self Tapping

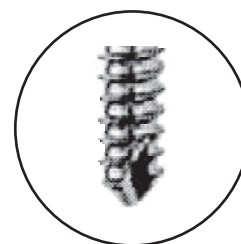
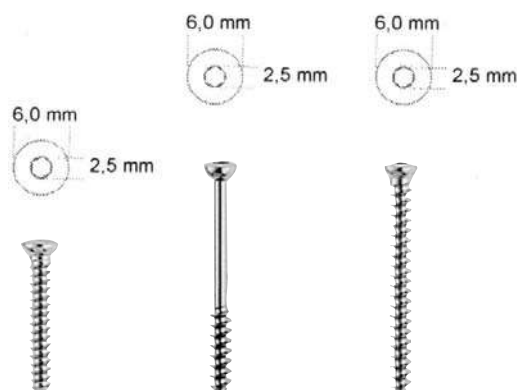

Self Cutting Screws,
Tapping Not Needed.

Dia of thread	3.5 mm	4.0 mm	4.0 mm
Pitch	1.25 mm	1.75 mm	1.75 mm
Dia of core	2.4 mm	1.9 mm	1.9 mm
Dia of Shaft		2.3 mm	2.3 mm
Dia of head	6.0 mm	6.0 mm	6.0 mm
Length			
10 mm	15-4610	15-4710	15-4810
12 mm	15-4612	15-4712	15-4812
14 mm	15-4614	15-4714	15-4814
16 mm	15-4616	15-4716	15-4816
18 mm	15-4618	15-4718	15-4818
20 mm	15-4620	15-4720	15-4820
22 mm	15-4622	15-4722	15-4822
24 mm	15-4624	15-4724	15-4824
26 mm	15-4626	15-4726	15-4826
28 mm	15-4628	15-4728	15-4828
30 mm	15-4630	15-4730	15-4830
32 mm	15-4632	15-4732	15-4832
34 mm	15-4634		
35 mm		15-4735	15-4835
36 mm	15-4636		
38 mm	15-4638		
40 mm	15-4640	15-4740	15-4840
42 mm	15-4642		
45 mm	15-4645	15-4745	15-4845
48 mm	15-4648		
50 mm	15-4650	15-4750	15-4850
55 mm	15-4655		15-4855
60 mm			15-4860

Bone Screws

Large Screws with large hexagonal flats 3.5 mm



Washers
124-175-11 11 mm
124-175-13 13 mm

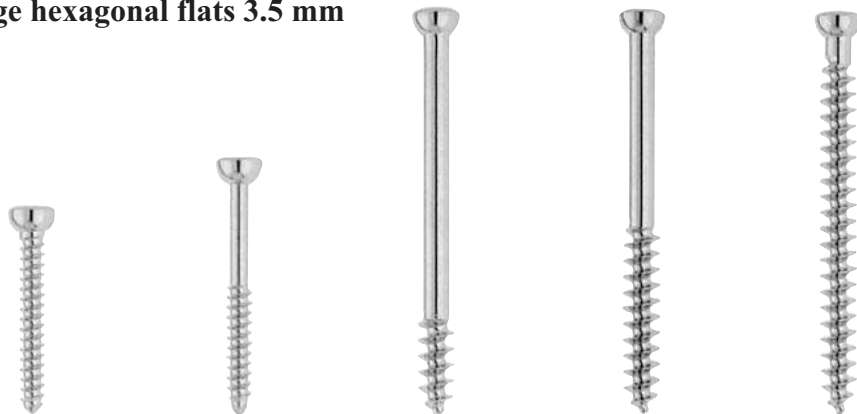

Dia of thread	4.5 mm	4.5 mm	6.5 mm	6.5 mm	6.5 mm
Dia of core	3.0 mm	3.0 mm	3.0 mm	3.0 mm	3.0 mm
Dia of shaft		3.0 mm	4.5 mm	4.5 mm	
Dia of head	8.0 mm	8.0 mm	8.0 mm	8.0 mm	8.0 mm
Length of thread	Full	Half	16 mm	32 mm	Full
14 mm	124-045-14				
16 mm	124-045-16				
18 mm	124-045-18				
20 mm	124-045-20	124-070-20			
22 mm	124-045-22				
24 mm	124-045-24				
25 mm		124-070-25			124-150-25
26 mm	124-045-26				
28 mm	124-045-28				
30 mm	124-045-30	124-070-30	124-105-30		124-150-30
32 mm	124-045-32				
34 mm	124-045-34				
35 mm		124-070-35	124-105-35		124-150-35
36 mm	124-045-36				
38 mm	124-045-38				
40 mm	124-045-40	124-070-40	124-105-40	124-125-40	124-150-40
42 mm	124-045-42				
44 mm	124-045-44				
45 mm		124-070-45	124-105-45	124-125-45	124-150-45
46 mm	124-045-46				
48 mm	124-045-48				
50 mm	124-045-50	124-070-50	124-105-50	124-125-50	124-150-50
52 mm	124-045-52				
54 mm	124-045-54				
55 mm		124-070-55	124-105-55	124-125-55	124-150-55
56 mm	124-045-56				
58 mm	124-045-58				
60 mm	124-045-60	124-070-60	124-105-60	124-125-60	124-150-60
65 mm	124-045-65	124-070-65	124-105-65	124-125-65	124-150-65
70 mm	124-045-70	124-070-70	124-105-70	124-125-70	124-150-70
75 mm	124-045-75	124-070-75	124-105-75	124-125-75	124-150-75
80 mm	124-045-80	124-070-80	124-105-80	124-125-80	124-150-80
85 mm	124-045-85		124-105-85	124-125-85	124-150-85
90 mm	124-045-90		124-105-90	124-125-90	124-150-90
95 mm	124-045-91		124-105-91	124-125-91	124-150-91
100 mm	124-045-92		124-105-92	124-125-92	124-150-92
105 mm	124-045-93		124-105-93	124-125-93	124-150-93
110 mm	124-045-94		124-105-94	124-125-94	124-150-94
115 mm	124-045-95		124-105-95	124-125-95	124-150-95
120 mm	124-045-96		124-105-96	124-125-96	124-150-96

Bone Screws, Self Tapping

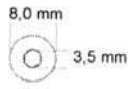

Dia of thread	4.5 mm	4.5 mm
Dia of core	3.0 mm	
Dia of Shaft		4.5 mm
Dia of head	8.0 mm	8.0 mm
Length		
14 mm	15-4914	
16 mm	15-4916	
18 mm	15-4918	
20 mm	15-4920	
22 mm	15-4922	15-5022
24 mm	15-4924	15-5024
25 mm		
26 mm	15-4926	15-5026
28 mm	15-4928	15-5028
30 mm	15-4930	15-5030
32 mm	15-4932	15-5032
34 mm	15-4934	15-5034
35 mm		
36 mm	15-4936	15-5036
38 mm	15-4938	15-5038
40 mm	15-4940	15-5040
42 mm	15-4942	15-5042
44 mm	15-4944	15-5044
45 mm		
46 mm	15-4946	15-5046
48 mm	15-4948	15-5048
50 mm	15-4950	15-5050
52 mm	15-4952	15-5052
54 mm	15-4954	15-5054
55 mm		
56 mm	15-4956	15-5056
58 mm	15-4958	15-5058
60 mm	15-4960	15-5060
65 mm	15-4965	15-5065
70 mm	15-4970	15-5070
75 mm	15-4975	15-5075
80 mm	15-4980	15-5080
85 mm	15-4985	15-5085
90 mm	15-4990	15-5090
95 mm	15-4995	15-5095
100 mm	15-4100	15-5100
105 mm	15-4105	15-5105
110 mm	15-4110	15-5110

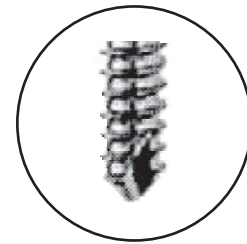

Self Cutting Screws,
Tapping Not Needed.

Mini Plates Plates for 2.0 mmØ screws



	Length	Holes
126-100-04	22 mm	4
126-100-05	27 mm	5
126-100-06	32 mm	6
126-100-07	37 mm	7
126-100-08	42 mm	8

Profil: 5.0 x 1.2 mm
Distance between holes: 5.0 mm

Mini T-Plates for 2.0 mm Screws
Primary Indication: Fracture of the phalanges

Profil:
Thick 4 - 6 holes 1.0 mm
Thick 7 - 8 holes 1.5 mm
Broad 5 mm
Distance 5 mm

	Length	Number of holes	
		In head	In Shaft
126-150-03	50 mm	3	9
126-150-04	50 mm	4	9



126-175-20 Straight Mini Plates for 2.0 mm screws with 20 holes, 100 mm length



126-178-35 Mini - Adaptationplate for 2.0 mm screws with 20 holes, 100 mm length



Straight Mini Plates

	Length	Holes
126-190-03	17 mm	3
126-190-04	23 mm	4
126-190-05	29 mm	5
126-190-06	35 mm	6

Profil:
Thick: 1.2 mm
Broad: 5 mm
Distance: 6 mm



126-192-04
oblique left



126-192-05
oblique right



126-193-07
straight



126-197-12
angled left 90°



126-197-13
angled right 90°

Mini Plates Plates for 2.7 mmØ screws



Profil: 8.0 x 2.0 mm
Distance between holes: 8.0 mm

	Length	Holes
126-205-02	20 mm	2
126-205-04	36 mm	4
126-205-05	44 mm	5
126-205-06	52 mm	6



Finger Plates
Quarter-tubular Plates

	Length	Holes
126-217-03	25 mm	3
126-217-04	33 mm	4
126-217-05	41 mm	5
126-217-06	49 mm	6
126-217-07	57 mm	7
126-217-08	65 mm	8

Profil: 8.0 x 2.5 mm
Distance between holes: 8.0 mm

	Length	Holes
126-125-07	60 mm	7
126-125-08	68 mm	8
126-125-09	76 mm	9
126-125-10	86 mm	10
126-125-12	100 mm	12



126-275-04
oblique left



126-275-05
oblique right



126-277-07
straight



126-280-12
angled left 90°



126-280-13
angled right 90°



126-283-17



15-410 Acetabulum Plates
6 Holes 31mm
for 1.5mm Screws



15-415 Acetabulum Plates
4 Holes 31mm
for 2.7mm and 3.5mm Screws



15-420 Acetabulum Plates
6 Holes 31mm
for 2.7mm and 3.5mm Screws



15-425 Buttress Plates
4 Holes 35mm
for 2.0mm Screws



15-430 Buttress Plates
5 Holes 36mm
for 2.0mm Screws

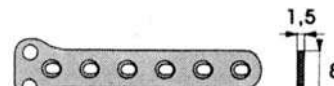

15-435 Buttress Plates
6 Holes 52mm
for 2.0mm Screws

T-Plates
for 2.7mm and 3.5mm Screws
15-440 6 Holes
15-445 6 Holes
15-450 7 Holes

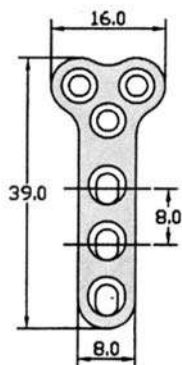

15-440

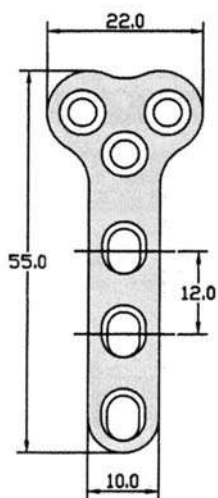

15-445

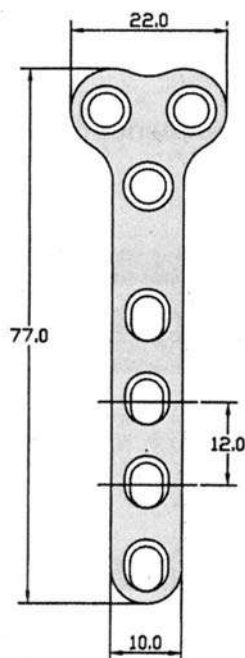

15-450

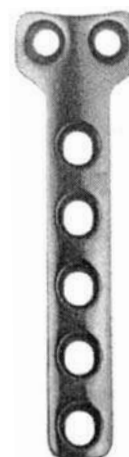

T-Plates
for 2.7mm and 3.5mm Screws
15-455 5 Holes
15-460 7 Holes
15-465 9 Holes

Carpal Arthrodesis Plates



15-470	Compression	2.0mm / 2.7mm
15-475	Compression	2.7mm / 3.5mm
15-480	Broad Compression	3.5mm / 3.5mm



Small Fragment Plates for 3.5 Ø Screws
 Profil 10 x 3mm Distance between Holes 12 and 16mm

	Length	Holes
15-485	25mm	2
15-490	37mm	3
15-495	49mm	4
15-500	61mm	5
15-505	73mm	6
15-510	85mm	7
15-515	97mm	8
15-520	109mm	9
15-525	121mm	10
15-530	145mm	12

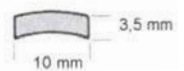

Small Fragment Plates with DC gliding Holes
 for Corticalis Screws Ø 3.5mm and Cancellous Ø 4.0mm

	Length	Holes
15-535	86mm	7
15-540	98mm	8
15-545	110mm	9
15-550	122mm	10
15-555	134mm	11
15-560	146mm	12
15-565	158mm	13
15-570	170mm	14
15-575	182mm	16
15-580	194mm	18
15-585	206mm	20
15-590	218mm	22



Miscellaneous Implants



15-595	Cut-to-Length Plates 2.0 / 1.5mm Dimensions: 1.0mm x 7mm x 300mm, 50 Round Holes
---------------	---



15-600	Cut-to-Length Plates 2.7 / 2.0mm Dimensions: 1.5mm x 7mm x 300mm, 50 Round Holes
---------------	---

Narrow Compression Plates



Profile: 12.0 x 3.8 mm
Distance between holes: 16 and 25 mm

	Length	Holes		Length	Holes
124-200-02	39 mm	2	124-200-10	167 mm	10
124-200-03	55 mm	3	124-200-11	183 mm	11
124-200-04	71 mm	4	124-200-12	199 mm	12
124-200-05	87 mm	5	124-200-13	215 mm	13
124-200-06	103 mm	6	124-200-14	231 mm	14
124-200-07	119 mm	7	124-200-15	247 mm	15
124-200-08	135 mm	8	124-200-16	263 mm	16
124-200-09	151 mm	9			

Broad Compression Plates



Profile: 16.0 x 4.8 mm
Distance between holes: 16 and 25 mm

	Length	Holes		Length	Holes
124-250-06	103 mm	6	124-250-13	215 mm	13
124-250-07	119 mm	7	124-250-14	231 mm	14
124-250-08	135 mm	8	124-250-15	247 mm	15
124-250-09	151 mm	9	124-250-16	263 mm	16
124-250-10	167 mm	10	124-250-17	279 mm	17
124-250-11	183 mm	11	124-250-18	295 mm	18
124-250-12	199 mm	12			

Semi- Tubular Plates



Profile: 12 x 1 mm
Distance between holes: 16 and 25 mm

	Length	Holes		Length	Holes
124-275-02	39 mm	2	124-275-07	119 mm	7
124-275-03	55 mm	3	124-275-08	135 mm	8
124-275-04	71 mm	4	124-275-09	151 mm	9
124-275-05	87 mm	5	124-275-10	167 mm	10
124-275-06	103 mm	6	124-275-11	183 mm	11
			124-275-12	199 mm	12

Straight Plates



Broad Lengthening Plates with 8 holes

	Amount of Lengthening	Length
124-375-30	30 mm	135 mm
124-315-40	40 mm	145 mm
124-315-50	50 mm	155 mm
124-315-60	60 mm	165 mm

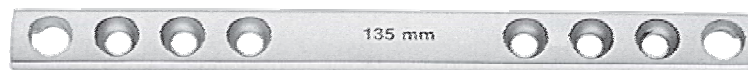

Narrow Lengthening Plates with 8 holes

	Amount of Lengthening	Length
124-390-30	30 mm	135 mm
124-390-40	40 mm	145 mm
124-390-50	50 mm	155 mm
124-390-60	60 mm	165 mm
124-390-70	70 mm	175 mm
124-390-80	80 mm	185 mm

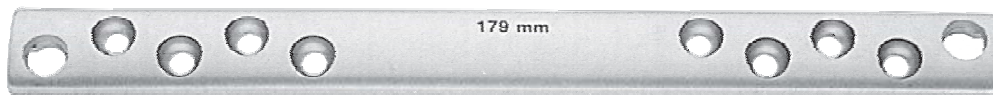

Broad Lengthening Plates with 10 holes

	Amount of Lengthening	Length
124-395-50	50 mm	179 mm
124-395-60	60 mm	189 mm
124-395-70	70 mm	199 mm
124-395-80	80 mm	209 mm
124-395-90	90 mm	219 mm
124-395-91	100 mm	229 mm
124-395-92	110 mm	239 mm
124-395-93	120 mm	249 mm

Intramedullary Gliding Nails

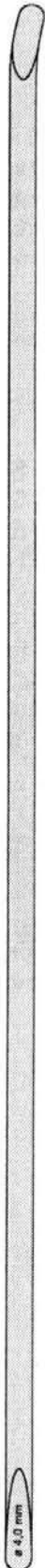

Stainless Steel DIN ISO 5832-1	
15-605	1.5 x 150mm
15-610	1.5 x 400mm
15-615	2.0 x 200mm
15-620	2.0 x 400mm
15-625	2.5 x 250mm
15-630	2.5 x 400mm
15-635	3.0 x 300mm
15-640	3.0 x 400mm
15-645	3.5 x 350mm
15-650	3.5 x 400mm

Protective Caps available according to diameter of Nail

15-655	Ø 1.5mm
15-660	Ø 2.0mm
15-665	Ø 2.5mm
15-670	Ø 3.0mm
15-675	Ø 4.0mm
15-680	Ø 4.5mm
15-685	Ø 5.0mm

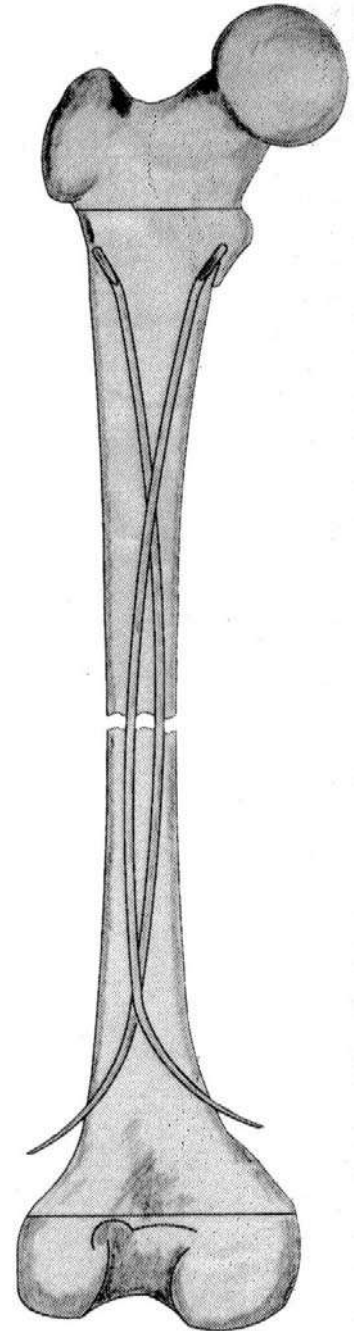

Trocar with Slotted Sleeve for Implantation of Medullary Gliding Nails

- 15-695** Trocar for Ø 3.5 - 5.0mm Nails
- 15-700** Trocar for Ø 1.5 - 3.5mm Nails



Impactor for all diameters of Gliding Nails

Centering Sleeve

Impactor Head

Handle

Fixation Screw



Centering Sleeves for diameter

- 15-705** 1.5 - 2.0mm
- 15-710** 2.5 - 3.0mm
- 15-715** 3.5 - 5.0mm

15-720 Impactor



130-155-13 Extraction Pliers for boring wire 130 mm

130-155-18 Extraction Pliers for boring wire 180 mm

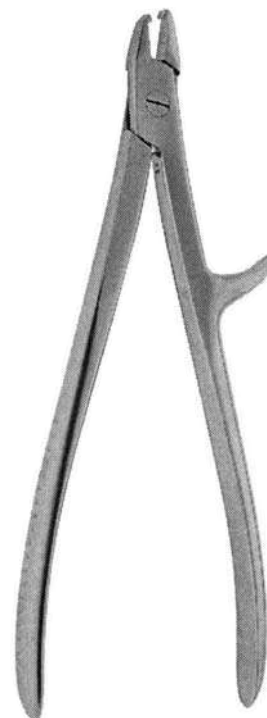

15-725 Extraction Pliers for Intramedullary Guiding Nails



100-915-16 Pfriem, AWL 160mm SS Hollow Handle

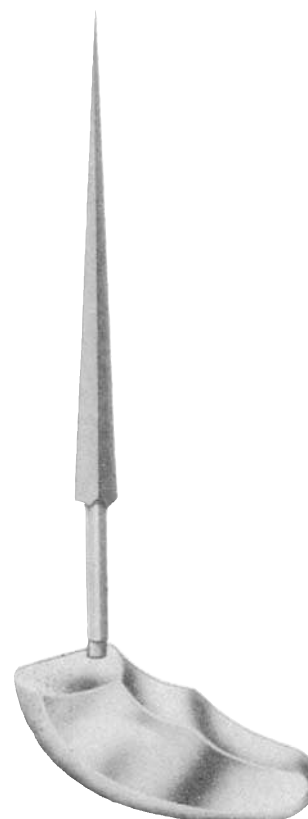

100-922-16 Perthes, 160 mm
100-922-22 Perthes, 220 mm

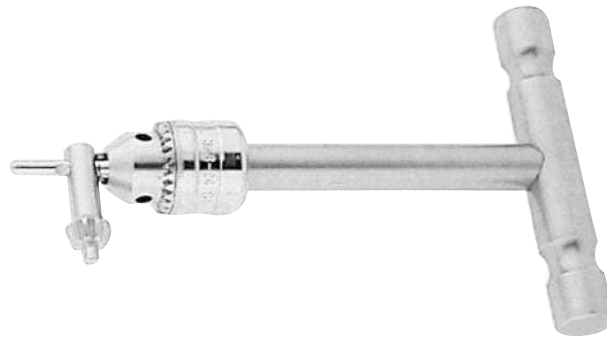

100-040-01 Jacob's Chuck with T-Handle and key
100-040-09 Jacob's Chuck only
100-042-05 Key for Jacob's Chuck



15-730 Nail Impactor Ø 1.5 - 2.5mm
15-735 Nail Impactor Ø 2.5 - 3.0mm
15-740 Nail Impactor Ø 3.5 - 5.0mm

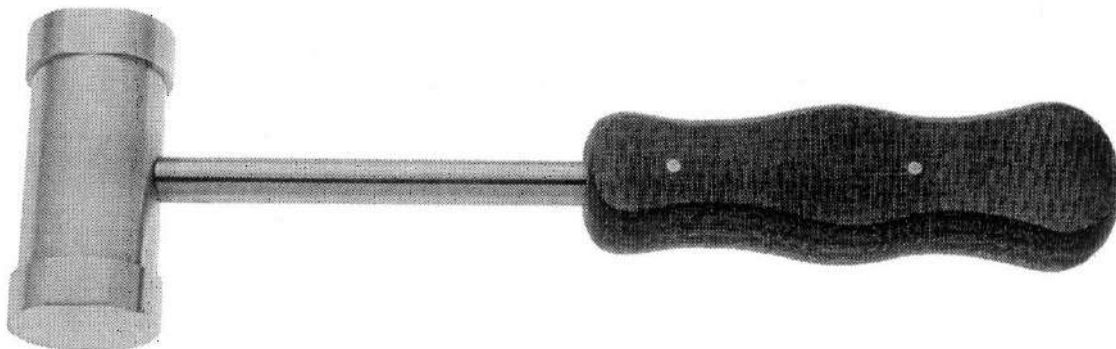

15-745 Bone Hammer / Weight approximatly : 350 Grams

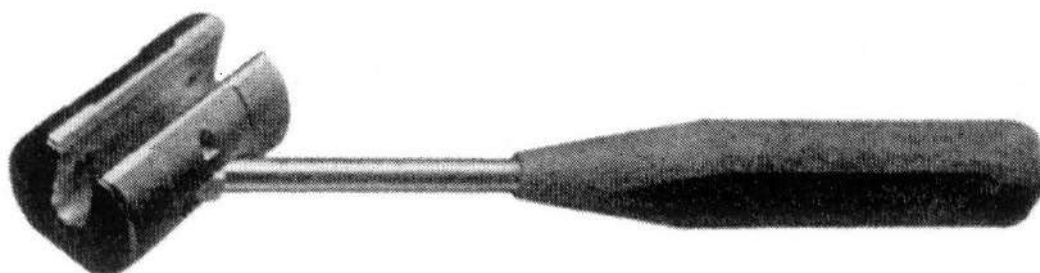

15-750 Slotted Hammer



130-220-25
Wire Cutter 220 mm TC
soft wire 3.0 mm
hard wire 2.5 mm

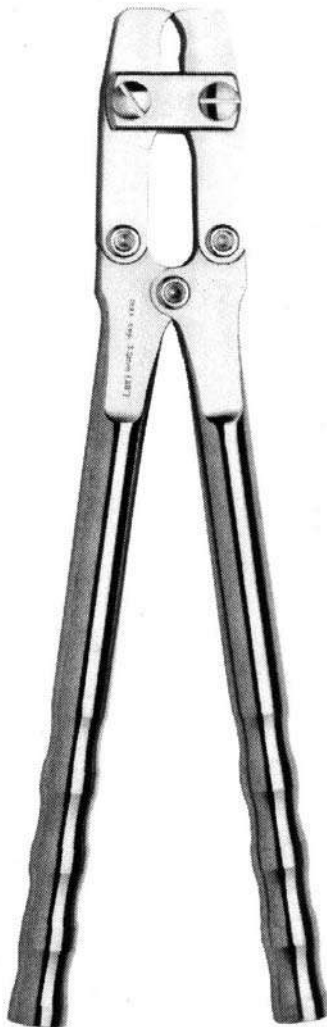

15-755
Hard Wire Cutter 3.5mm
260mm

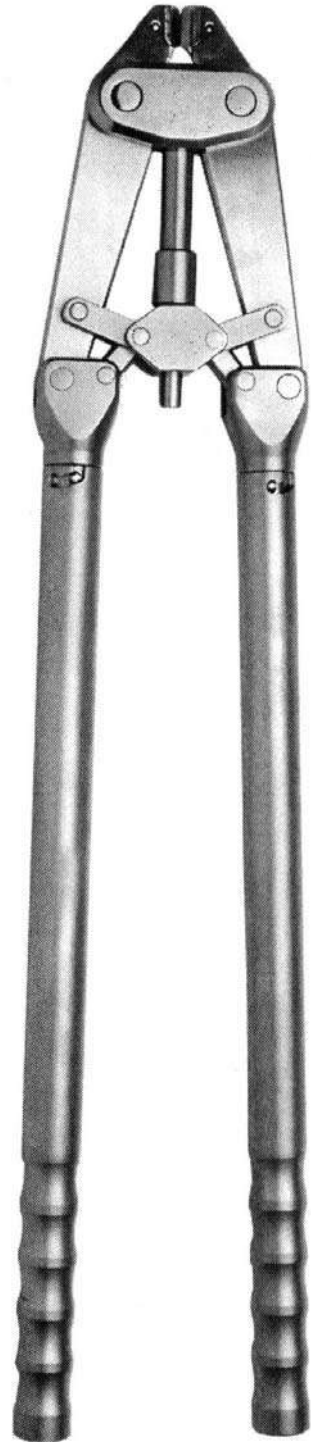

15-760
Hard Wire Cutter 6mm

Kirschner Wires

Point	Trocar	Trocar
Shaft End	Round	Trocar
Length	310mm	310mm
Ø 1.0mm	15-9010	15-9110
Ø 1.2mm	15-9012	15-9112
Ø 1.4mm	15-9014	15-9114
Ø 1.5mm	15-9015	15-9115
Ø 1.6mm	15-9016	15-9116
Ø 1.8mm	15-9018	15-9118
Ø 2.0mm	15-9020	15-9120
Ø 2.2mm	15-9022	15-9122
Ø 2.5mm	15-9025	15-9125
Ø 3.0mm	15-9030	

Point	Trocar	Trocar	Trocar
Shaft End	Round	Round	Trocar
Length	70mm	150mm	150mm
Ø 0.8 mm	15-9308	15-9408	15-9508
Ø 1.0 mm	15-9310	15-9410	15-9510
Ø 1.2 mm		15-9412	15-9512
Ø 1.4 mm		15-9414	15-9514
Ø 1.5 mm	15-9315	15-9415	15-9515
Ø 1.6 mm		15-9416	15-9516
Ø 1.8 mm		15-9418	15-9518
Ø 2.0 mm		15-9420	15-9520
Ø 2.2 mm		15-9422	15-9522
Ø 2.5 mm	15-9325	15-9425	15-9525
Ø 3.0 mm		15-9430	

Kirschner Wires with thread and trocar points, Round End



	Diameter	Length	Threaded Length
15-9616	1.6mm	150mm	5mm
15-9617	1.6mm	150mm	15mm
15-9618	2.0mm	150mm	15mm
15-9619	2.0mm	200mm	15mm
15-9620	2.5mm	200mm	15mm
15-9621	2.5mm	200mm	20mm



130-175-50 Bending Iron
for Kirschner Wires

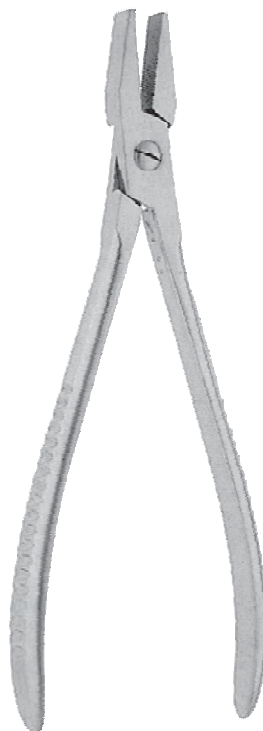

130-178-20 Pliers with serrated
jaws and groove
130-178-25 Pliers with serrated
jaws without groove

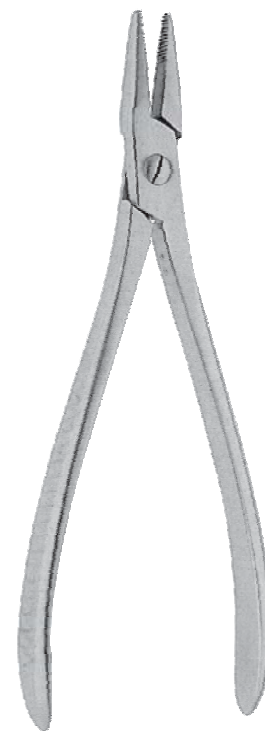

130-180-18 Rounded Pliers with
serrated jaws

Wire Drill Dispenser

Easy to transport and storage

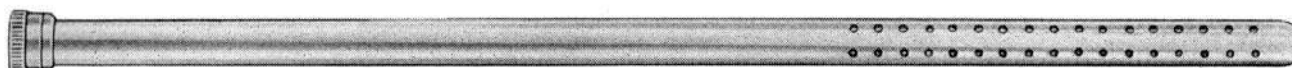

Wire Length	Wire Ø 0.8 mm	Wire Ø 1.0 mm	Wire Ø 1.2 mm	Wire Ø 1.4 mm	Wire Ø 1.6 mm	Wire Ø 2.0 mm	Wire Ø 2.2 mm	Wire Ø 2.5 mm
16.0 cm	15-9708	15-9710	15-9712	15-9714	15-9716	15-9720	15-9722	15-9725
31.0 cm	15-9808	15-9810	15-9812	15-9814	15-9816	15-9820	15-9822	15-9825

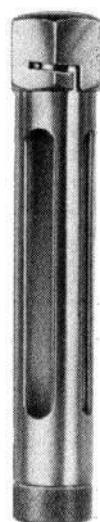

15-905

This specially designed dispenser holds four different wire gauges
1.0 / 1.2 / 1.4 / and 1.6mm, each 10cm long.

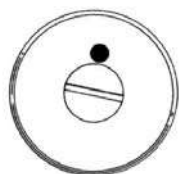

Wire Drill Dispenser

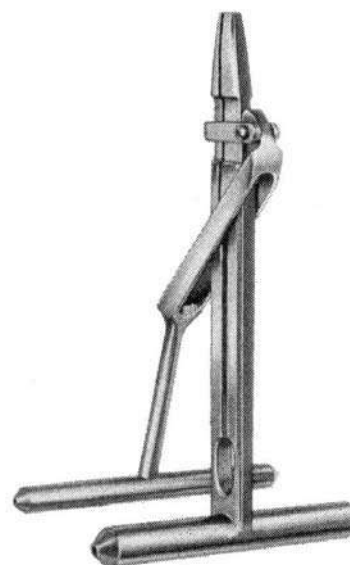

15-910 Vickers Easidriver

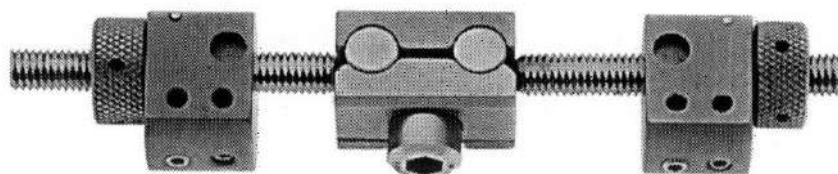

15-925 TREUFIX No. I

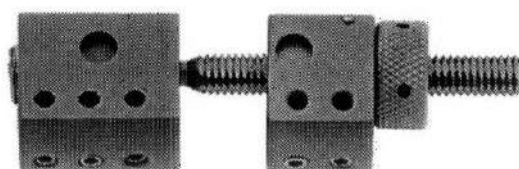

15-930 TREUFIX No. II



15-335 TREUFIX No. III



15-940 Kirschner Wire with thread and trocar point Ø 1.8mm, 70mm long, 30mm thread

15-945 Kirschner Wire with thread and trocar point Ø 1.6mm, 70mm long, 30mm thread

Small External Fixater Set



100-003-20 Drill Bit 2.0 mm
100-003-25 Drill Bit 2.5 mm



145-502-07 Combination Wrench,
width across flats, 7 mm



145-507-07 Socket Wrench,
Width across flats, 7 mm



145-510-48 Drill Sleeve complete



145-512-50 Drill sleeve 5.0 / 4.0 mm



145-513-40 Drill sleeve 5.0 / 4.0 mm



145-514-27 Trokar, \varnothing 2.7 mm



Connecting bars, 4.0 mm diam.
Stainless steel

145-550-06	60 mm
145-550-08	80 mm
145-550-10	100 mm
145-550-12	120 mm
145-550-14	140 mm
145-550-16	160 mm
145-550-18	180 mm
145-550-20	200 mm



145-565-02 Clamp Open 2.5 - 5.0 mm \varnothing



145-568-04 Clamp 2.5 - 5.0 mm \varnothing



145-572-05 Open Compressor



145-575-07 Spring loaded Nut

Schanz Screw for External Fixation



15-950 Shaft Ø 2.4 mm
Threaded Ø 3.2 mm
Length 100 mm

15-955 Shaft Ø 3.2 mm
Threaded Ø 4.0 mm
Length 120 mm

15-960 Shaft Ø 4.0 mm
Threaded Ø 4.8 mm
Length 150 mm



15-965 Shaft Ø 2.4 mm
Threaded Central Ø 3.2 mm
Length 100 mm

15-970 Shaft Ø 3.2 mm
Threaded Central Ø 4.0 mm
Length 120 mm

15-975 Shaft Ø 4.0 mm
Threaded Central Ø 4.8 mm
Length 150 mm



Cerclage wire soft, in coils of 10 meter

Ømm	0.2	0.3	0.4	0.5	0.6	0.7	0.8	0.9	1.0	1.2	1.5
Gauge	31	29	27	25	23	22	21	20	19	18	17
Cat. No.:	130-010-02	130-010-03	130-010-04	130-010-05	130-010-06	130-010-07	130-010-08	130-010-09	130-010-10	130-010-12	130-010-15



Cerclage wire with eye, soft

	Diameter	Length
130-012-08	0.8 mm	280 mm
130-012-10	1.0 mm	280 mm
130-012-12	1.2 mm	280 mm
130-014-10	1.0 mm	600 mm
130-014-12	1.2 mm	600 mm

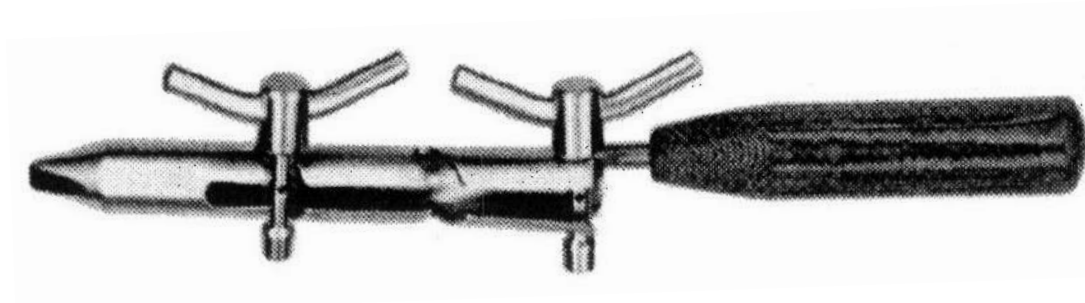

130-133-33 Wire Tightener



130-102-10 Parham Martin Band Tightener



130-102-19 Parham Metal Bone Bands 19 cm x 0.5 mm



130-122-22 Loute 22 cm Bone Wire Tightener

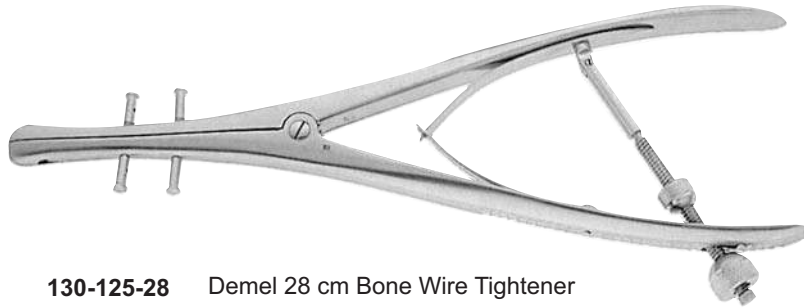

130-125-28 Demel 28 cm Bone Wire Tightener



130-128-30 Wire Tightener

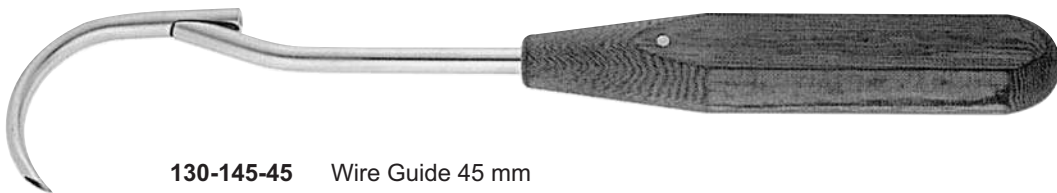

130-145-45 Wire Guide 45 mm



130-145-70 Wire Guide 70 mm



130-150-18 Extraction Pliers for wire 180 mm

130-152-18 Extraction Pliers TC jaws



130-155-13 Extraction Pliers for boring wire 130 mm

130-155-18 Extraction Pliers for boring wire 180 mm

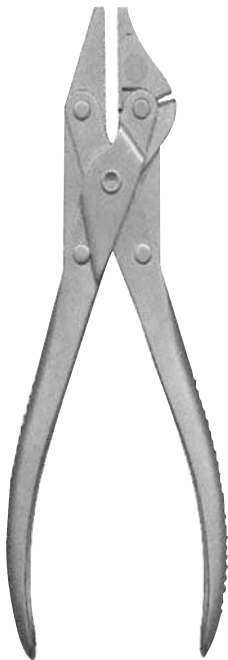

130-168-18 Flat-nosed Pliers, parallel, with lateral wire cutter, 180 mm Stainless Steel



130-170-18 Vise Grip 180 mm Stainless Steel

130-170-20 Vise Grip 200 mm Stainless Steel

130-170-24 Vise Grip 240 mm Stainless Steel

Extraction Instruments



130-162-20 Extraction Pliers,
200 mm TC



130-160-19 Extraction Pliers,
190 mm TC



130-172-18 Wire Tightening
Pliers T/C 180 mm



130-190-10 Wire Bending Cutting
Pliers soft wire 1.5 mm
Hard Wire 1.0 mm



130-200-10 Universal Scissors
130-200-12 Universal Scissors
with TC cutting edges



130-208-10 Wire Bending Pliers
soft Wire 1.5 mm
Hard Wire 1.0 mm



130-203-15 Wire Cutter T/C



130-214-12 Wire Cutter
soft wire 2.0 mm
Hard wire 1.2 mm

Wire Cutters



130-218-15 T/C 180 mm
Soft wire 2.0 mm
Hard wire 1.5 mm



130-220-25 Wire Cutter 220 mm T/C
Soft wire 3.0 mm
Hard wire 2.5 mm



130-224-15 180 mm frontal and lateral cutting action T/C
Soft wire 2.0 mm
Hard wire 1.5 mm



130-240-08 Wire Cutter 140 mm TC
Soft wire 1.2 mm
Hard wire 0.8 mm



130-242-22 Wire Cutter 220 mm TC
Soft Wire 2.5 mm
Hard Wire 2.2 mm

Diamond Pin Cutter



15-980 Wire Cutter
Hard Wire 2.0mm



15-985 Wire Cutter
Cannulated 180mm
Soft Wire 2.4mm
Hard Wire 1.6mm

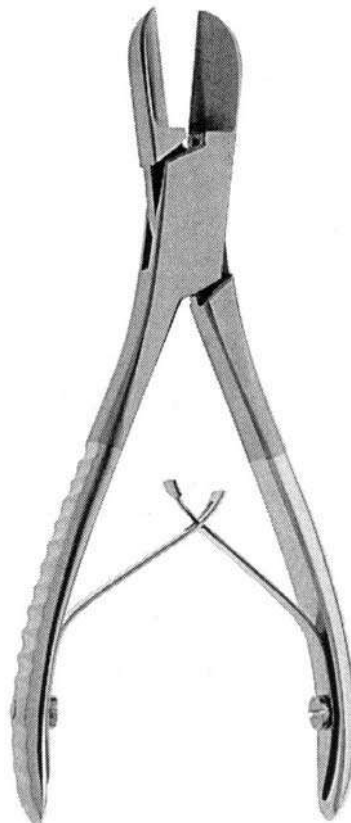

15-990 Wire Cutter T/C
Hard Wire 1.2mm

Wire Cutter

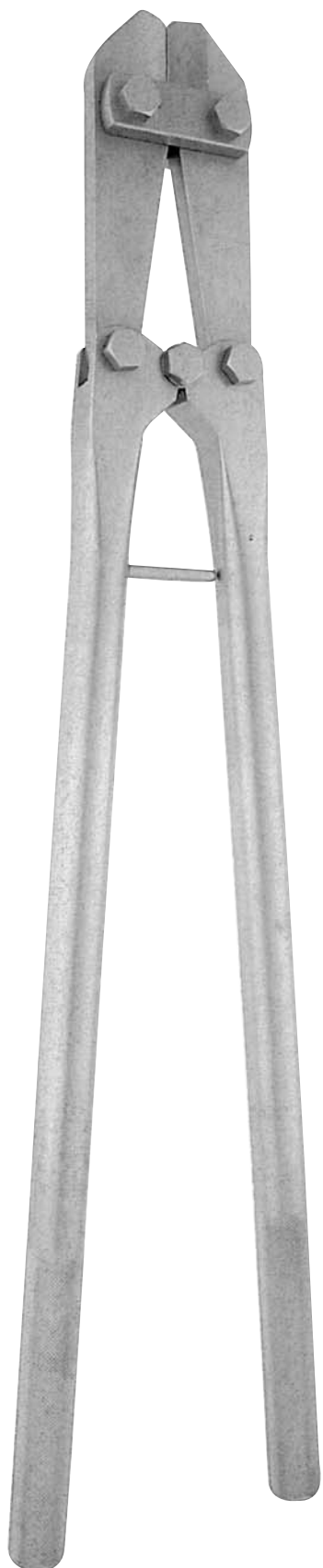

130-246-60

Cutter for cutting of Kirschner wires
Sreinmann Pins up to 6 mm Ø Hard
460 mm T/C

130-254-60

Cutter for cutting of Kirschner wires
Sreinmann Pins up to 6 mm Ø Hard
540 mm T/C

Staples - Chrome Cobalt Molybden



- 128-250-06 6 mm
- 128-250-08 8 mm
- 128-250-11 11 mm
- 128-250-14 14 mm

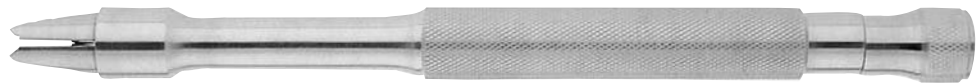

128-270-18 Impactor



- 128-002-16 Barbed Staples 8.7 x 16 x 2 mm
- 128-002-19 Barbed Staples 8.7 x 19 x 2 mm
- 128-002-22 Barbed Staples 8.7 x 22 x 2 mm
- 128-002-25 Barbed Staples 8.7 x 25 x 2 mm



	Diameter	Width	Length
128-015-22	1.5 mm	22 mm	19 mm
128-015-16	1.5 mm	16 mm	19 mm
128-025-22	2.5 mm	22 mm	19 mm
128-025-16	2.5 mm	16 mm	19 mm

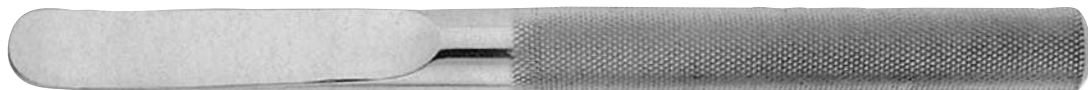

128-130-25 Staples Extractor

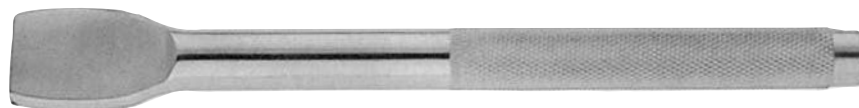

128-132-16 Staples Driver

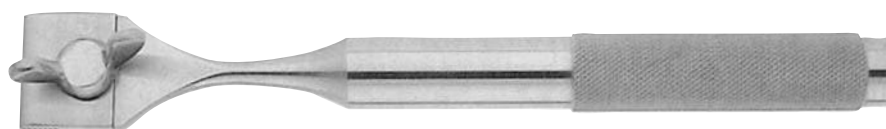

128-134-19 Staples Inserter

Drill Bit and Tap Handles

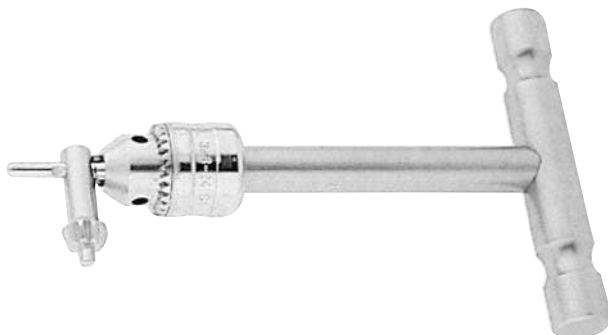

100-040-01 Jacob's Chuck with T-Handle and key
(Complete)

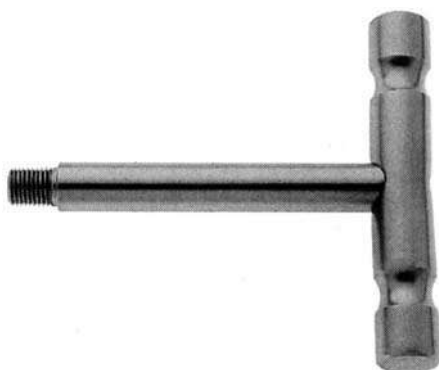

100-040-02 T-Handle

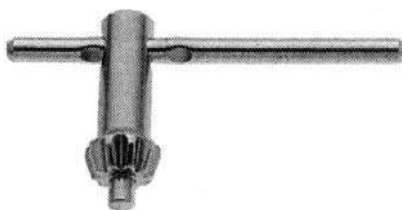

100-042-05 Key for Jacob's Chuck

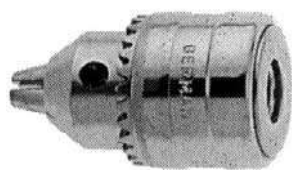

100-040-09 Jacob's Chuck only

Drill Bit and Tap Handles



Drill Bits

Size	Round Shaft	AO Coupling
1.1mm	100-001-11	100-003-11
1.5 mm	100-001-15	100-003-15
2.0 mm	100-001-20	100-003-20
2.5 mm	100-001-25	100-003-25
2.7 mm	100-001-27	100-003-27
3.2 mm	100-001-32	100-003-32
3.2 mm(long)	100-001-32L	100-003-32L
3.5 mm	100-001-35	100-003-35
3.5 mm(long)	100-001-35L	100-003-35L
4.5 mm	100-001-45	100-003-45
4.5 mm(long)	100-001-45L	100-003-45L



Taps

Size	T-Handle	AO Coupling
1.5 mm		
2.0 mm		
2.7 mm	100-011-27	100-013-27
3.5 mm(cortical)	100-011-35	100-013-35
3.5 mm(cancellous)	100-011-35D	100-013-35D
4.0 mm	100-011-40	100-013-40
4.5 mm(short thread)	100-011-45	100-013-45
4.5 mm(long thread)	100-011-45D	100-013-45D
6.5 mm	100-011-65	100-013-65

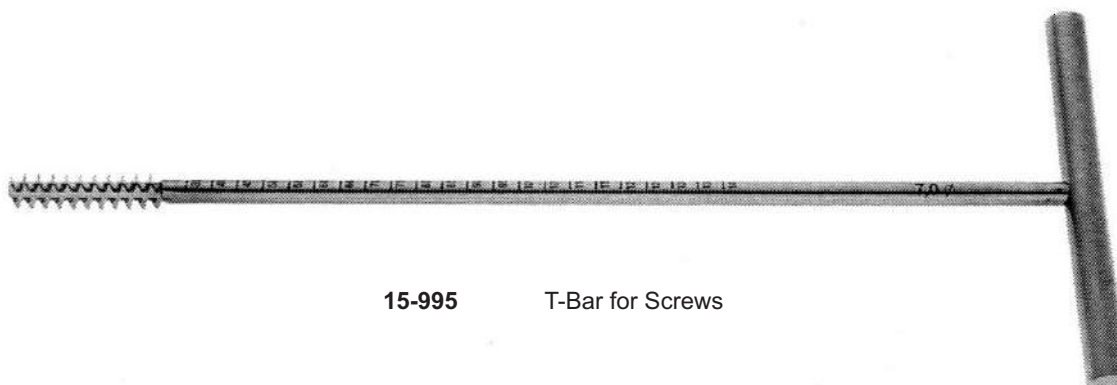

15-995

T-Bar for Screws

Drill Bit and Tap Handles



100-030-11 Handle for dental Coupling



100-032-32 Fiber Handle for AO Coupling



100-034-02 T-Handle for AO Coupling

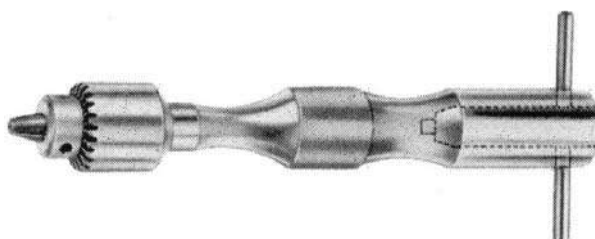

16-100 T-Handle Chuck and Key
Fully Cannulated
Accept items up to diameter of 4.5mm

Instruments for Screw Fixation



100-021-15 Mini Countersink
for 1.5 mm Screws 2.00 mm Diam Tip 1.1 mm



100-021-27 Small Countersink
for 2.7, 3.5 mm and 4.0 mm Screws Tip 2.0 mm



100-021-45 Malleolar Countersink
Tip 3.2 mm

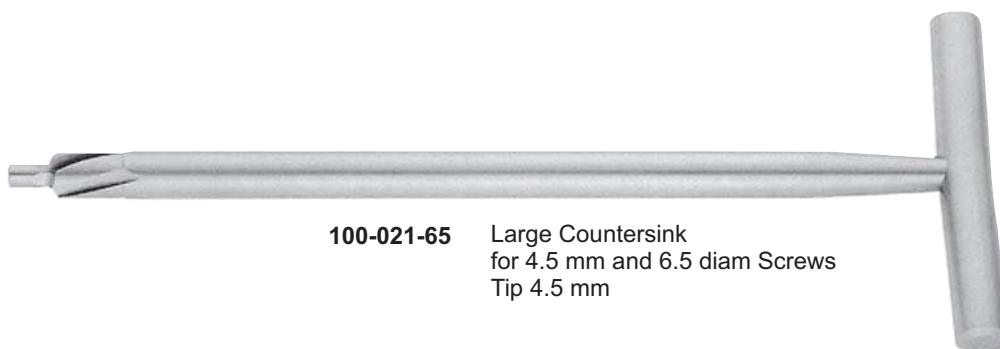

100-021-65 Large Countersink
for 4.5 mm and 6.5 diam Screws
Tip 4.5 mm



100-070-15 Depth Gauge for 1.5 mm and 2.0 mm screws
100-070-35 Depth Gauge for 2.7 mm and 4.0 mm screws
100-070-45 Depth Gauge for 4.5 mm and 6.5 mm screws



100-073-16 Sharp Hook



100-072-02 Screw Forcep

Screw Drivers / Instruments for Screw Fixation



100-051-20 Screw Driver single head



100-052-48 Screw Driver philips head



100-053-10 Screw Driver slotted head



A



B



C



D



- 100-055-01** A Screw Driver Williams for Phillips Head
- 100-055-03** B Screw Driver Williams for Slotted Head
- 100-055-04** C Screw Driver Williams for Single Head
- 100-055-06** D Screw Driver Williams for Hexagonal Head 3.5 mm



Hexagonal Head

Size of screws	Head Size	Fiber-Handle	AO Coupling	Dental Coupling
1.5mm	1.5mm	100-061-15	100-063-15	100-064-15
2.0mm				
2.7mm	2.5mm	100-061-25	100-063-25	
3.5mm				
4.0mm				
4.5mm	3.5mm	100-061-35	100-063-35	
6.5mm				



100-065-15 Holding Sleeve 1.5 mm



100-065-25 Holding Sleeve 2.5 mm

Instruments for Screw Fixation / Drill Sleeves / Drill Guides



100-101-11 Mini Drill Sleeve for 1.1 mm and 1.5 mm drill bits
100-101-15 Mini Drill Sleeve for 1.5 mm and 2.0 mm drill bits



100-103-20 Drill Guide and drill sleeve for 2.0 mm drill bit



100-105-27 Tap Sleeve, 2.0 mm Ø
 Drill Sleeve, 2.7 mm Ø
100-105-35 Tap Sleeve, 2.5 mm Ø
 Drill Sleeve, 3.5 mm Ø

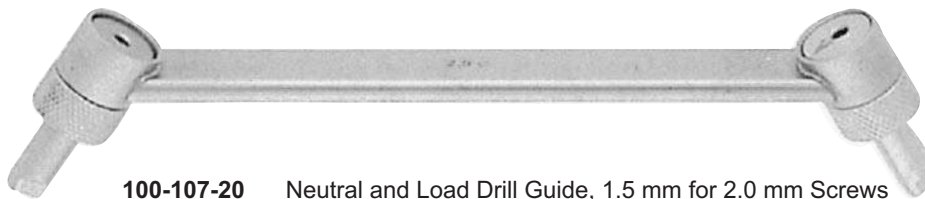

100-107-20 Neutral and Load Drill Guide, 1.5 mm for 2.0 mm Screws
100-107-27 Neutral and Load Drill Guide, 2.0 mm for 2.7 mm Screws
100-107-35 Neutral and Load Drill Guide, 2.5 mm for 3.5 mm Screws
100-107-45 Neutral and Load Drill Guide, 3.2 mm for 4.5 mm Screws



100-112-35 Tap Sleeve, 3.5 mm
 also for used as 3.2 mm drill Guide



100-115-45 Tap Sleeve, 4.5 mm



100-118-32 Drill sleeve 3.2 mm for Round Hole Plates

Instruments for Screw Fixation / Drill Sleeves / Drill Guides



- 100-120-27** Insert Drill Sleeve 2.7 / 2.0 mm Drill Bit 2.0 mm
- 100-120-35** Insert Drill Sleeve 3.5 / 2.5 mm Drill Bit 2.5 mm
- 100-120-45** Insert Drill Sleeve 4.5 / 3.2 mm Drill Bit 3.2 mm

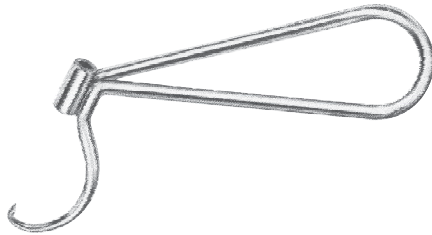

100-122-35 Small Pointed Drill for Drill Bit 3.5 mm



100-123-58 Pointed Drill Guide 6.5 mm

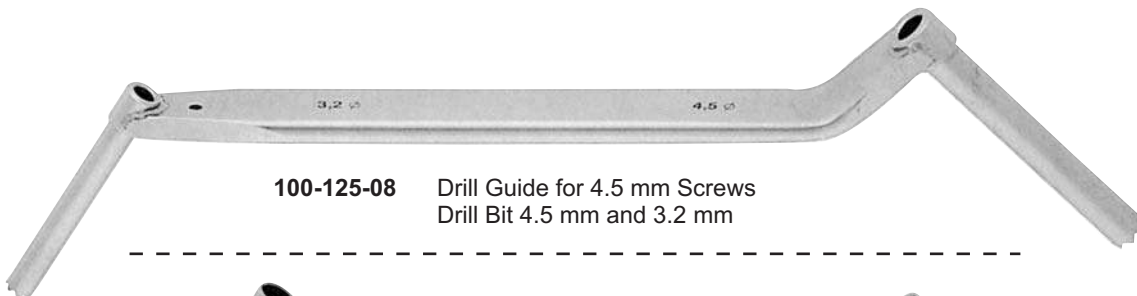

100-125-08 Drill Guide for 4.5 mm Screws
Drill Bit 4.5 mm and 3.2 mm

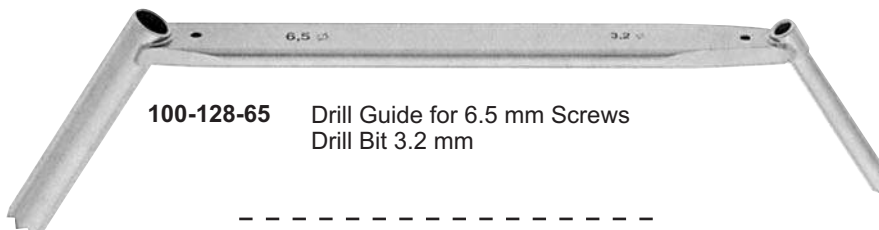

100-128-65 Drill Guide for 6.5 mm Screws
Drill Bit 3.2 mm

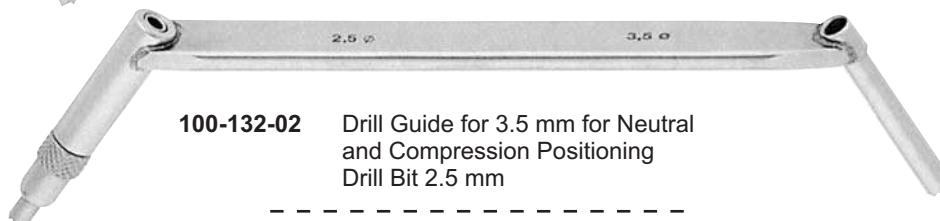

100-132-02 Drill Guide for 3.5 mm for Neutral and Compression Positioning
Drill Bit 2.5 mm



100-135-45 C - Clamp Drill Guide with thread for Drill Bit 4.5 mm



- 190-110-45** Bending Templates for curved Reconstruction Plates 4.5 mm
- 190-112-45** Bending Templates for straight Reconstruction Plates 4.5 mm
- 190-114-35** Bending Templates for curved Reconstruction Plates 3.5 mm
- 190-116-35** Bending Templates for straight Reconstruction Plates 3.5 mm



100-093-45 Bending Iron for 3.5 mm and 4.5 mm Plates

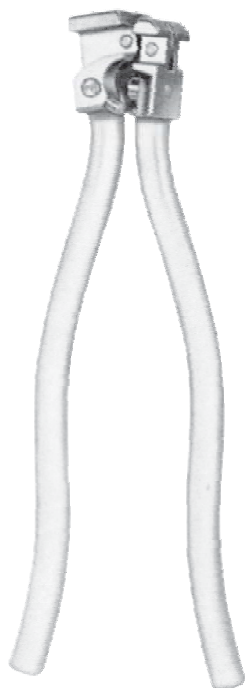

100-093-35 Bending Pliers for 2.7 mm and 3.5 mm Plates



190-130-15 Osteotomy Chisels 304 mm, 15 mm
190-130-20 Osteotomy Chisels 304 mm, 20 mm

Bending Instruments for Plates



100-090-01 Bending Iron for Mini Plates



100-090-02 Bending Irons for small plates to be used as a pair



100-090-03 Bending Irons for small plates to be used as a pair



16-105 Bending Pliers for 2.7 and 3.5mm Plates, 24cm
16-110 Bending Pliers for 1.0 and 2.0mm Plates, 20cm

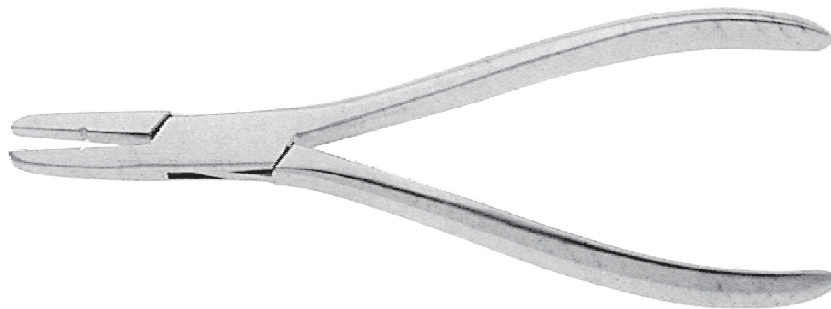

100-092-15 Bending Pliers for 1.5 and 2.0 mm Plates



100-092-27 Bending Pliers for 2.7 and 3.5 mm plates

Self - Centering Bone Holding Forceps With Thread Lock



Kern
100-182-16 160 mm with ratchet
100-182-21 210 mm with ratchet
100-183-16 160 mm without ratchet
100-183-21 210 mm without ratchet



Lane
100-178-33 330 mm
100-178-45 450 mm

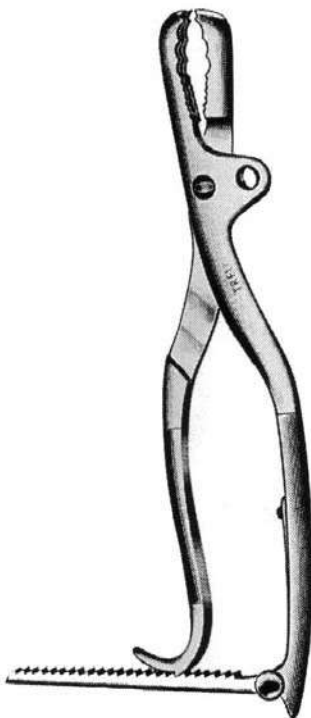

16-115 Farabeuf-Lambotte Bone Holding Forceps
260mm with Ratchet
16-120 Farabeuf-Lambotte Bone Holding Forceps
260mm without Ratchet



Lambotte
100-191-22 220 mm
100-191-27 270 mm
100-191-33 330 mm



Self-Centering Bone Holding Forceps with Thread Lock

- 100-215-15** For small fragments 150 mm, jaw 9 mm
- 100-215-19** Size 0, 190 mm, extra small jaw 10 mm
- 100-215-24** Size 1, 240 mm, extra small jaw 14 mm



100-220-19 Ulrich
Straight 190 mm



100-200-14 Verbrugge 175 mm



100-298-16 Reduction Forceps with
Thread Lock 160 mm



100-240-20
Semb 200 mm

100-240-30
Semb 200 mm with Ratchet



100-278-13
Reduction Forceps
for small fragments 135 mm



100-284-14
Forceps with Ratchet
Fixation 145 mm



100-270-17
Reil, 170 mm



100-280-13
Holding Forceps for
Mini 135 mm



100-295-23 Reposition Forceps 230 mm

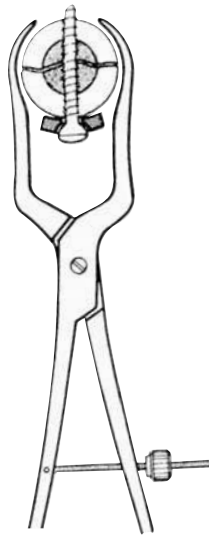

100-298-16 Reduction Forceps
100-298-24 160 mm with Thread Lock
240 mm with Thread Lock

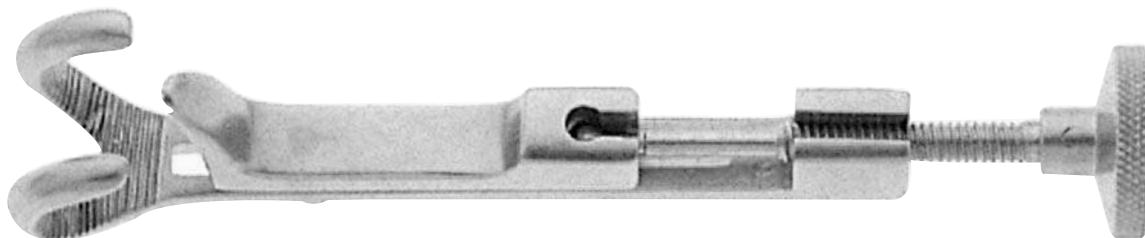
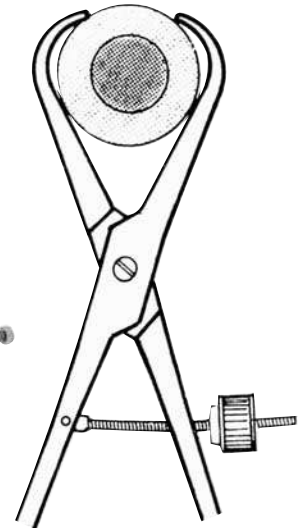

100-325-13 Lowmann Bone Clamp 130 mm
100-325-18 Lowmann Bone Clamp 185 mm
100-325-30 Lowmann Bone Clamp 300 mm



100-221-26 Ulrich 260 mm



Ulrich
100-220-19 190 mm
100-220-23 230 mm
100-220-25 250 mm
100-220-28 280 mm

Standard Retractors

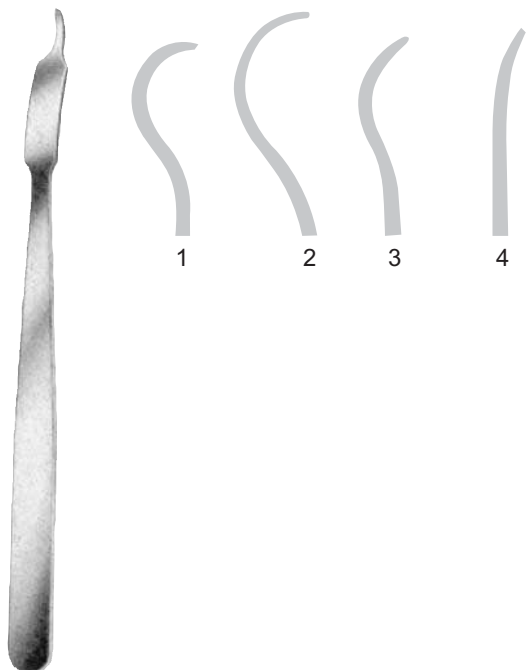

Fig. 1 100-352-06 Periosteal Elevator 175 mm
For Metacarpals Small
6 mm width

Fig. 2 100-352-10 For Metacarpals Medium
10 mm width

Fig. 3 100-352-45 Light Curve, Rounded End,
5 mm width

Fig. 4 100-352-50 Contra Angled Curve
4.5 mm width



100-358-06
Small, width 6 mm
short, narrow tip

100-360-08
Small, width 8 mm
short, narrow tip

100-364-15
For Small Fragments
Board Shank



100-368-08
Width 8 mm
short, narrow tip



100-374-18 Width 18 mm short,
narrow tip

100-376-18 Width 18 mm long,
narrow tip



100-376-43 Width 43 mm
narrow tip

100-376-70 Width 70 mm
narrow tip



100-378-43
Width 43 mm
long shank, angled

Periosteal Elevators



100-725-14
Medium straight blade
round edge, width 14 mm



100-727-14
Medium curved blade
round edge, width 14 mm

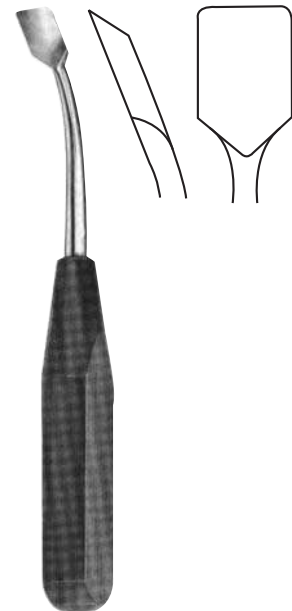

Medium Blade
Straight Edge, 14 mm
Straight 185 mm
100-728-14 Curved 185 mm
100-729-14



100-732-14
large straight blade
round edge, width 20 mm



100-735-06
Small curved blade
round edge, width 6 mm



100-740-06
Small curved blade
straight edge, width 6 mm



100-742-03
Extra small curved blade
round edge, width 3 mm

Chisels / Gouges / Osteotomes



100-650-00 Chisel Handle



- 100-650-05** Chisel Blade 5 mm
- 100-650-10** Chisel Blade 10 mm
- 100-650-16** Chisel Blade 16 mm
- 100-650-25** Chisel Blade 25 mm



Mini- Lambothe

- 100-640-02** 170 mm length 2 mm width
- 100-640-05** 170 mm length 5 mm width
- 100-640-10** 170 mm length 10 mm width



100-650-40
Wrench for Chisel Handle



- 100-680-05** Straight 5 mm
- 100-680-10** Straight 10 mm
- 100-680-15** Straight 15 mm
- 100-681-05** Curved 5 mm
- 100-681-10** Curved 10 mm
- 100-681-15** Curved 15 mm



- 100-656-10** Flat 10 mm
- 100-656-15** Flat 15 mm
- 100-656-20** Flat 20 mm
- 100-656-25** Flat 25 mm



- 100-657-10** Hollow 10 mm
- 100-657-15** Hollow 15 mm
- 100-657-20** Hollow 20 mm
- 100-657-25** Hollow 25 mm

Chisels / Gouges / Osteotmes



Hoke 13.5cm
 16-125 3mm
 16-130 5mm
 16-135 6mm
 16-140 8mm
 16-145 9mm



Lucas 16cm
 16-150 3mm
 16-155 5mm



Lucas 16cm
 16-160 4mm
 16-165 6mm

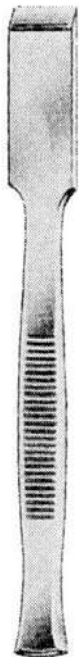

13.5cm
 16-170 8mm
 16-175 10mm
 16-180 12mm
 16-185 14mm
 16-190 16mm



13.5cm
 16-195 8mm
 16-200 10mm
 16-205 12mm
 16-210 14mm
 16-215 16mm



13.5cm
 16-220 8mm
 16-225 10mm
 16-230 12mm
 16-235 14mm
 16-240 16mm

Chisels / Gouges / Osteotomes



Partsch

2 mm
100-625-02
135 mm

5 mm
100-625-05
135 mm

2 mm
100-626-02
170 mm

5 mm
100-626-05
170 mm

3 mm
100-625-03
135 mm

6 mm
100-625-06
135 mm

3 mm
100-626-03
170 mm

6 mm
100-626-06
170 mm

4 mm
100-625-04
135 mm

4 mm
100-626-04
170 mm



Alexander 180 mm

4 mm
100-628-04

8 mm
100-628-08

12 mm
100-628-12

6 mm
100-628-06

10 mm
100-628-10

14 mm
100-628-14



Lambotte

100-642-10	Straight 10 mm	100-643-10	Curved 10 mm
100-642-15	Straight 15 mm	100-643-15	Curved 15 mm
100-642-20	Straight 20 mm	100-643-20	Curved 20 mm
100-642-25	Straight 25 mm	100-643-25	Curved 25 mm
100-642-30	Straight 30 mm	100-643-30	Curved 30 mm
100-642-38	Straight 38 mm	100-643-38	Curved 38 mm
100-642-44	Straight 44 mm	100-643-44	Curved 44 mm
100-642-50	Straight 50 mm	100-643-50	Curved 50 mm



Stille

	Chisels		Osteotome
100-635-10	10 mm	100-636-10	10 mm
100-635-12	12 mm	100-636-12	12 mm
100-635-15	15 mm	100-636-15	15 mm
100-635-20	20 mm	100-636-20	20 mm
100-635-25	25 mm	100-636-25	25 mm

Chisels / Periosteal Raspatories



100-775-18 Langenbeck 180 mm



100-778-19 Langenbeck 190 mm



100-782-10 Lambotte 10 mm
100-782-15 Lambotte 15 mm
100-782-20 Lambotte 20 mm



100-784-14 Farabeuf











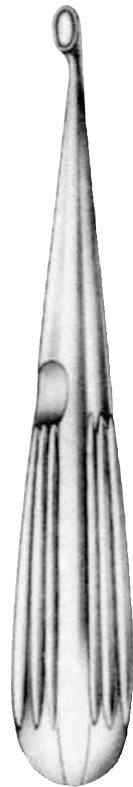

100-785-14 Farabeuf



Periosteal Raspator
100-788-05 5 mm
100-788-06 6 mm
100-788-07 7 mm









Bone Cutettes



- | | | |
|---|--|---|
| 
Fig. 0000
100-801-40 | 
Fig. 000
100-801-30 | 
Fig. 00
100-801-20 |
| 
Fig. 0
100-801-10 | 
Fig. 1
100-801-01 | 
Fig. 2
100-801-02 |
| 
Fig. 3
100-801-03 | 
Fig. 4
100-801-04 | 
Fig. 5
100-801-05 |

Spratt

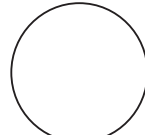

- | | | |
|---|--|---|
| 
Fig. 0000
100-804-40 | 
Fig. 000
100-804-30 | 
Fig. 00
100-804-20 |
| 
Fig. 0
100-804-10 | 
Fig. 1
100-804-01 | 
Fig. 2
100-804-02 |
| 
Fig. 3
100-804-03 | 
Fig. 4
100-804-04 | 
Fig. 5
100-804-05 |
| | | 
Fig. 6
100-804-06 |

Bruns

Amputation Retractor and Saws



100-882-27 Charriere 27 cm
100-882-30 Charriere 30 cm



100-885-35 Charriere 35 cm

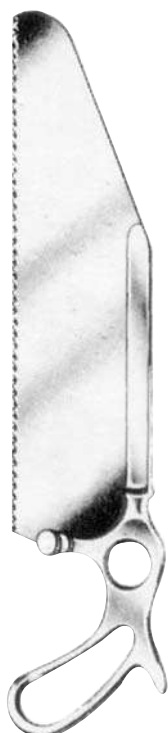

100-886-31 Satterlee 31 cm

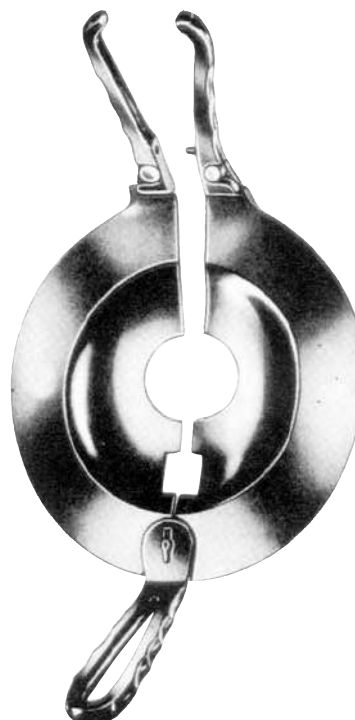

100-890-01 Percy Retractor



- 100-870-30** Gigli Saw, stainless 300 mm
- 100-870-40** Gigli Saw, stainless 400 mm
- 100-870-50** Gigli Saw, stainless 500 mm
- 100-870-70** Gigli Saw, stainless 700 mm



100-873-02 Gigli Handle



100-879-31 De Martel 31 cm, Saw Guide

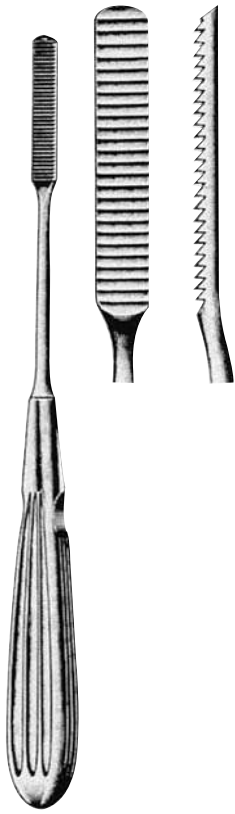

150-308-01
Cottle, 210 mm

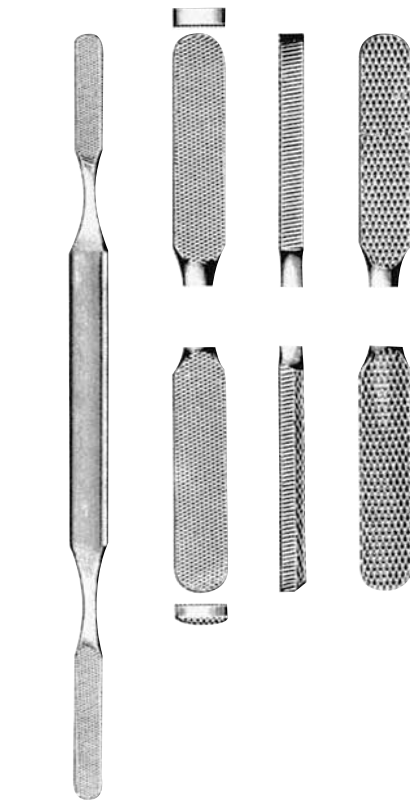

150-312-11
Cottle, 210 mm



Aufricht
210 mm

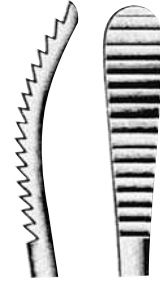

150-315-03

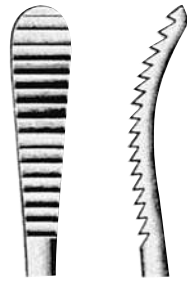

150-315-04

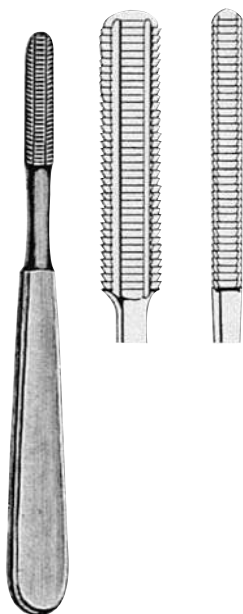

150-318-18
Maltz, 180 mm



Lewis, 180 mm

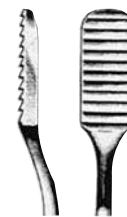

150-322-03
fine



150-322-04
coarse

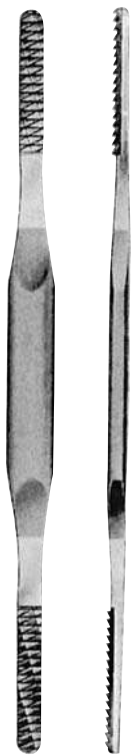

Fomon, 200 mm

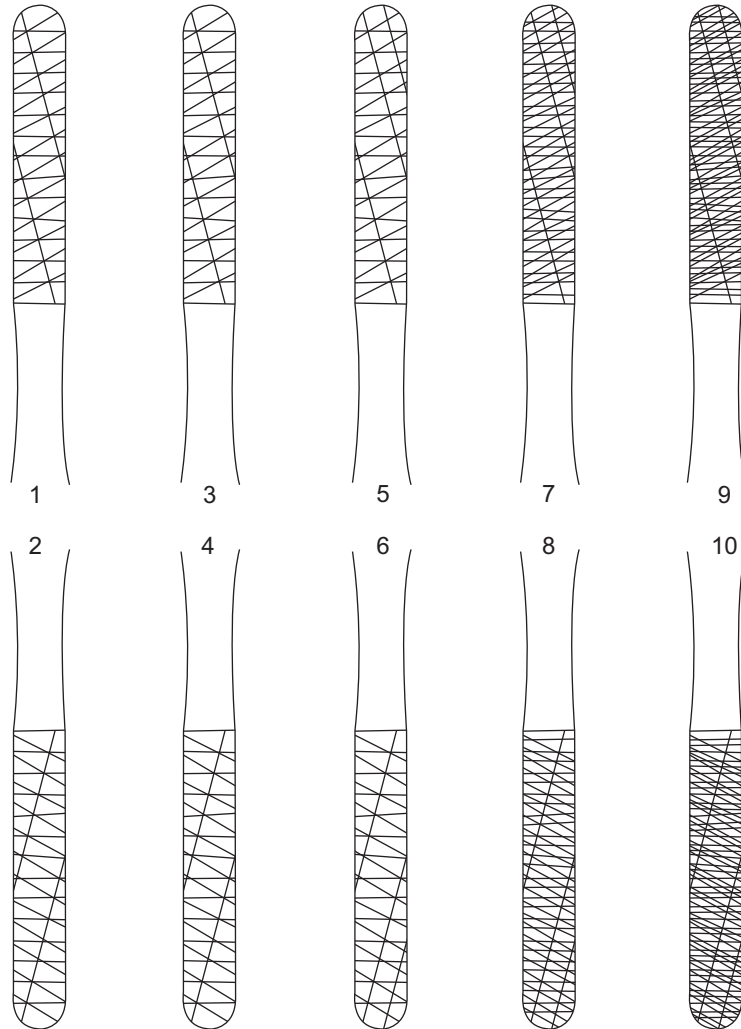

150-325-01

150-325-03

150-325-05

150-325-07

150-325-09



100-935-38 Putti, 280 mm



100-938-30 Putti, 300 mm

Bone Cutting Forceps

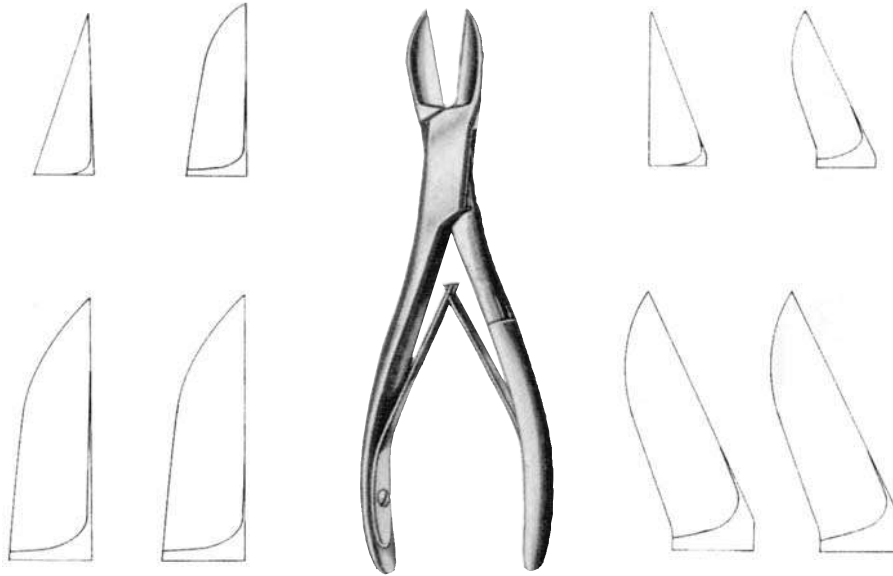

- 102-010-14** 140 mm straight
- 102-010-17** 170 mm straight
- 102-010-19** 190 mm straight
- 102-010-22** 220 mm straight

- 102-011-14** 140 mm curved
- 102-011-17** 170 mm curved
- 102-011-19** 190 mm curved
- 102-011-22** 220 mm curved

Liston Bone Cutting Forceps



102-030-27 Stille Horsley 270 mm

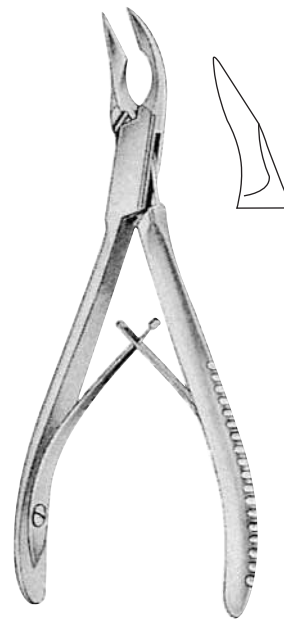

102-005-15 Cleveland, 150 mm

Bone Rongeurs

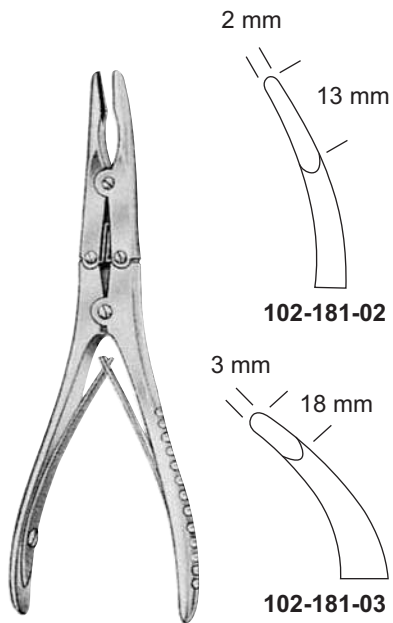

Kleinert-Kutz
150 mm

102-230-15
Ruskin-Mini
150 mm

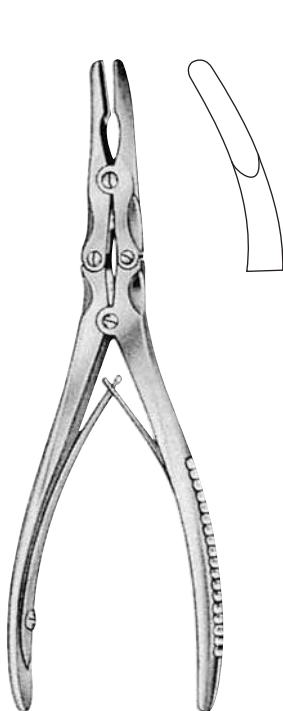

102-219-03 Beyer, 180 mm

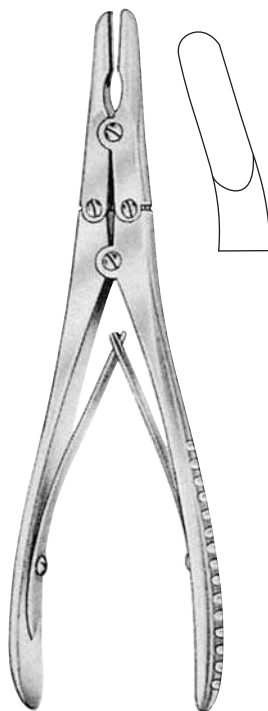

102-231-07 Ruskin, 180 mm

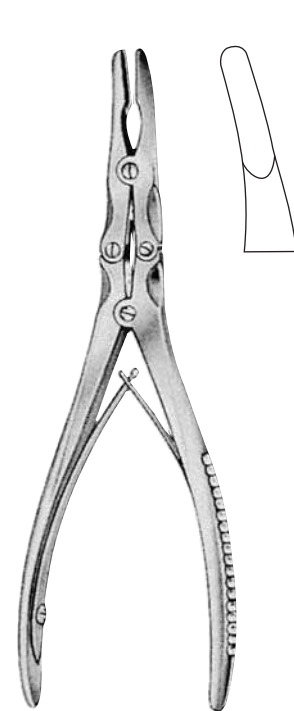

102-235-19 Zaufal-Jansen, 190 mm

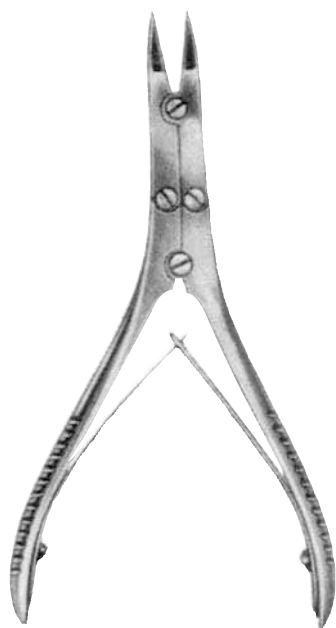

102-020-15 Bohler 150 mm straight
102-021-15 Bohler 150 mm curved



102-025-19 Ruskin-Liston 190 mm straight
102-026-19 Ruskin-Liston 190 mm curved



102-037-27 Stille-Liston 270 mm straight
102-038-27 Stille-Liston 270 mm curved



102-033-27 Stille Semb 270 mm

Bone Rongeur Forceps

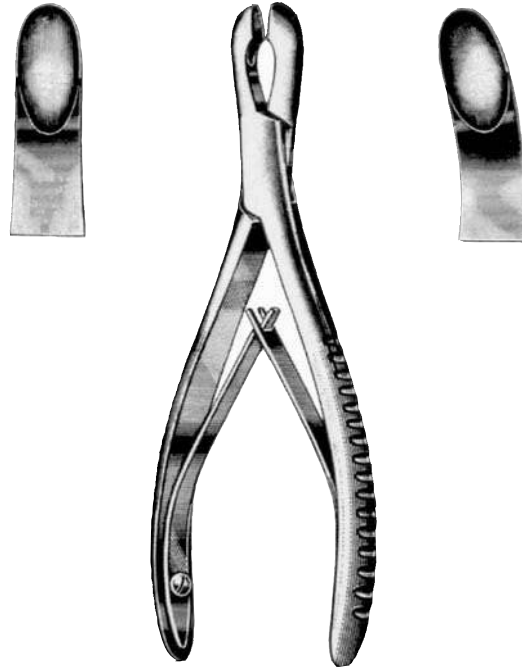

102-207-17 Luer 170 mm straight
102-208-17 Luer 170 mm curved

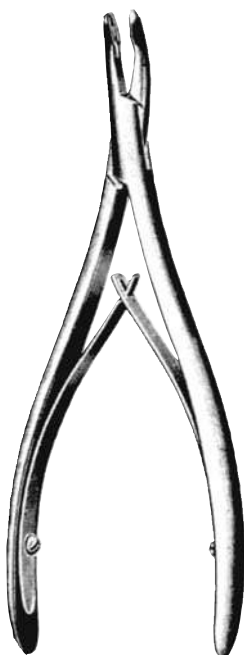

102-215-19 Lempert 190 mm straight
102-216-19 Lempert 190 mm curved

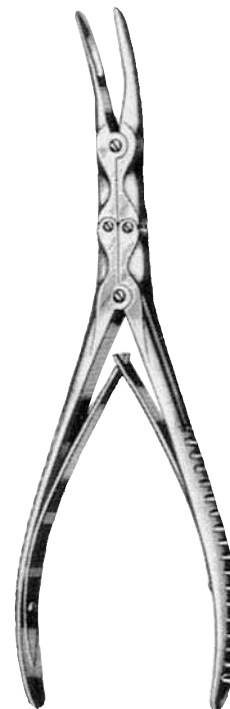

102-219-03 Beyer Rongeur, curved

Awls and Files

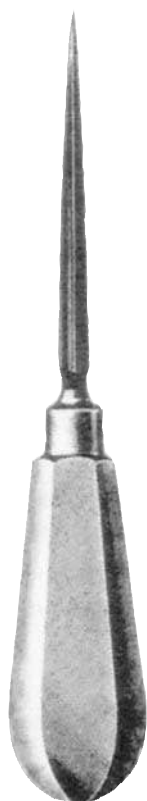

100-915-16 160 mm

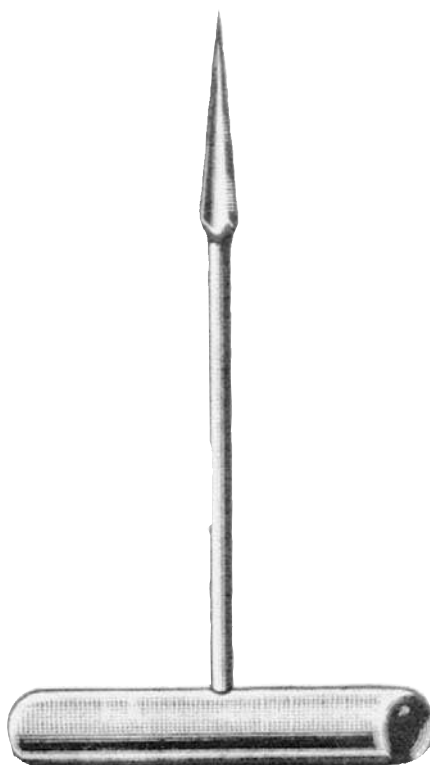

100-917-15 150 mm

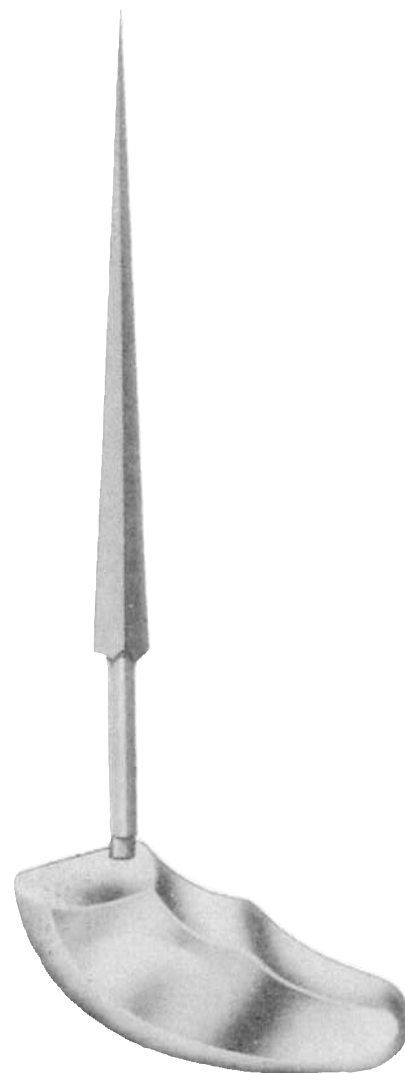

100-922-16 Perthes, 160 mm
100-922-22 Perthes, 220 mm

Bone Hammers



- 100-602-35** Weight approx:350 g
- 100-602-50** Weight approx:500 g(standard size)
- 100-602-70** Weight approx:700 g (For Medullary Nailing)

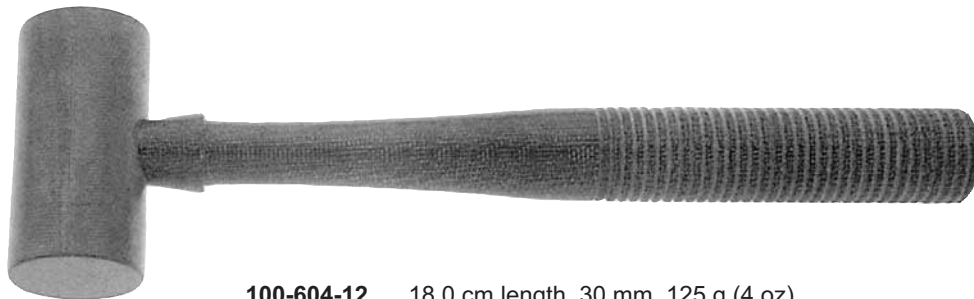

- 100-604-12** 18,0 cm length, 30 mm, 125 g (4 oz)
- Material Ferozell can be sterilized in an autoclave at 3 bar overpressure (143°C)

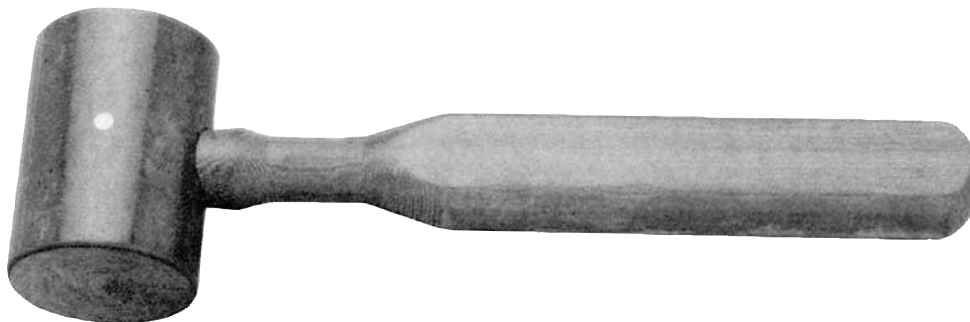

- 100-609-25** 42 mm, 250 mm
- Material Ferozell can be sterilized in an autoclave at 3 bar overpressure (143°C)



- 100-612-21** 30 mm / 215 g
- with interchangeable Plastic disks 250 mm
- 100-613-02** Pair of spare disks

Bone Hammers

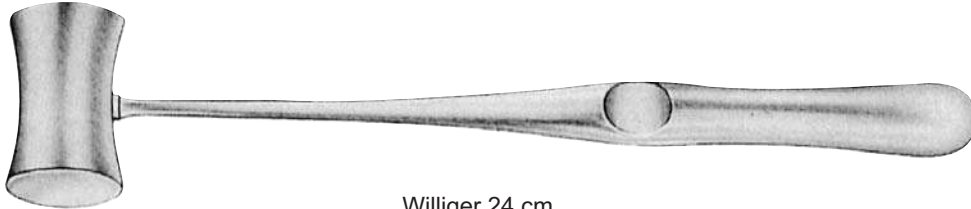

100-580-26 Williger 24 cm
Ø26 mm, 300 gr.
100-580-28 Ø28 mm, 340 gr.
100-580-30 Ø30 mm, 400 gr.

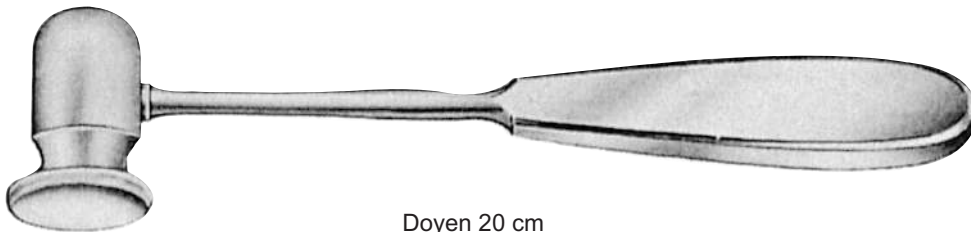

100-582-25 Doyen 20 cm
Ø25 mm, 120 gr.
100-582-30 Ø30 mm, 180 gr.
100-582-35 Ø35 mm, 260 gr.

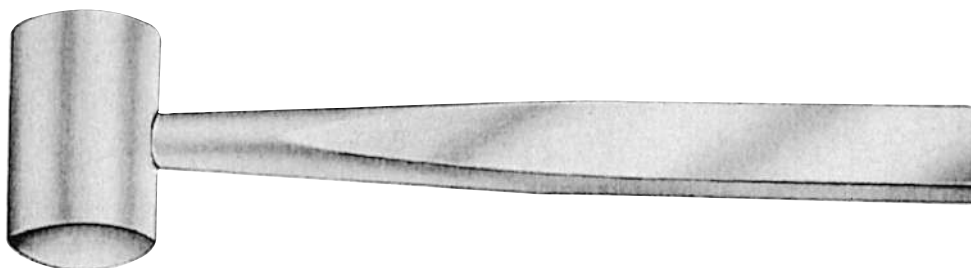

100-583-19 Cottle 190 mm
240 gr.

Bone Hammers

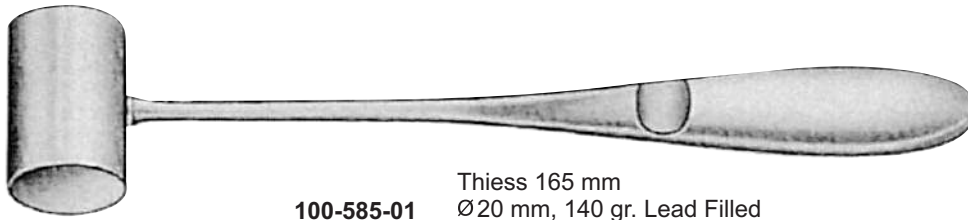

Thies 165 mm
100-585-01 Ø20 mm, 140 gr. Lead Filled
100-585-02 Ø20 mm, 140 gr. Brass Solid

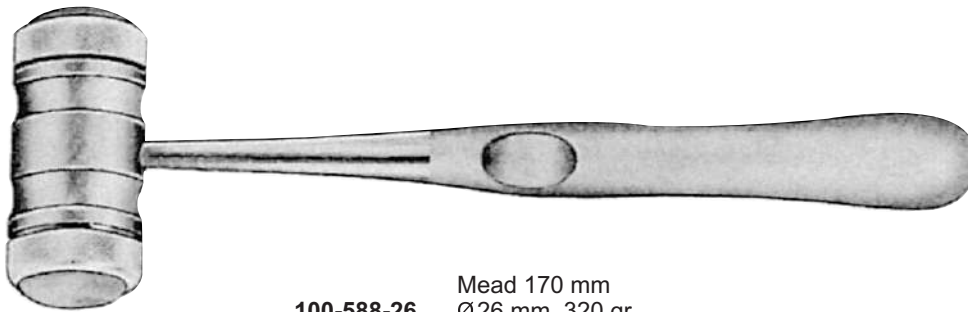

Mead 170 mm
100-588-26 Ø26 mm, 320 gr.

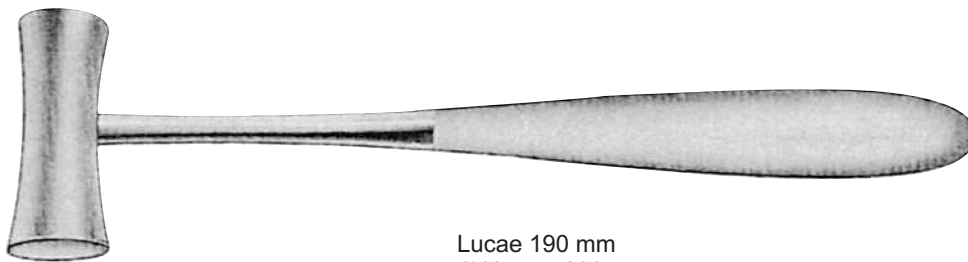

Lucae 190 mm
100-590-19 Ø19 mm, 230 gr.
100-590-25 Ø25 mm, 260 gr.

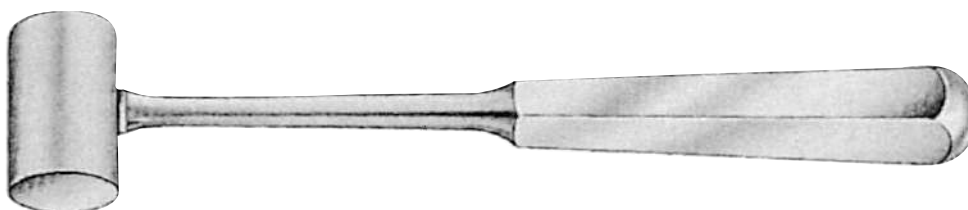

Partsch 180 mm
100-592-22 Ø22 mm, 200 gr.

Universal Bone Drills



100-045-03 Ralk
Hand Drill light metal case and laterally angled handle, with 3 - jaw chuck and key, opening up to 6.35 mm diameter



100-045-01 Bunnell
with channel for k-wires up to 3 mm diam.

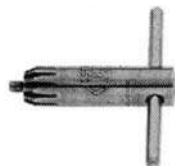

16-245 Wrench / Key

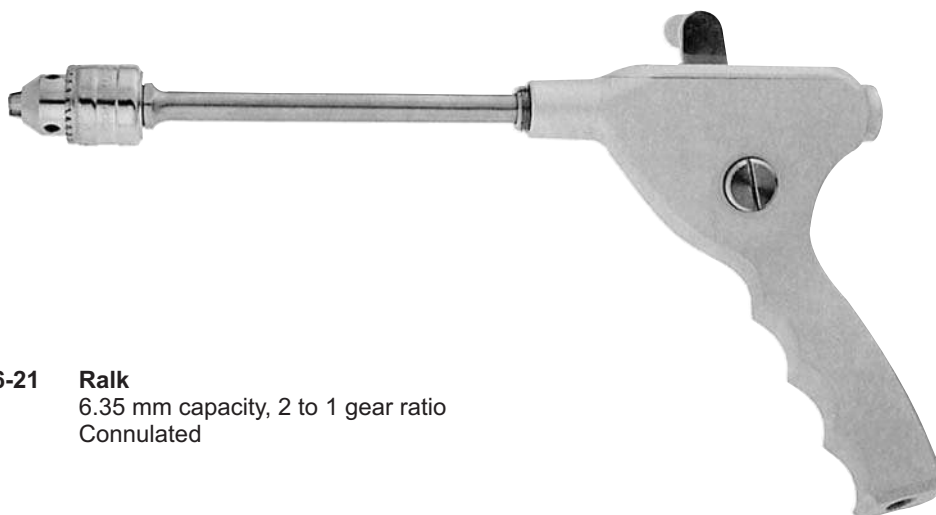

100-046-21 Ralk
6.35 mm capacity, 2 to 1 gear ratio
Connulated

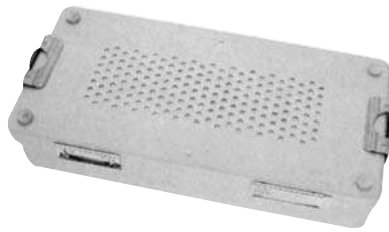

Lid Perforated



Cat. No.:	L (mm)	B (mm)	H (mm)
196-024-40	300	140	40
196-024-70	300	140	70

Tray For Container

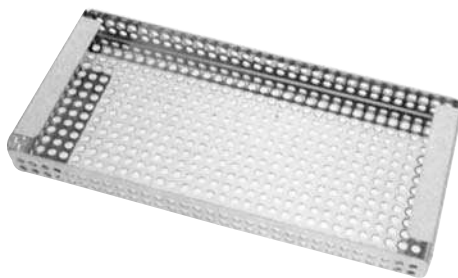

Lid Perforated



Cat. No.:	L (mm)	B (mm)	H (mm)
196-028-40	300	140	40
196-028-70	300	140	70

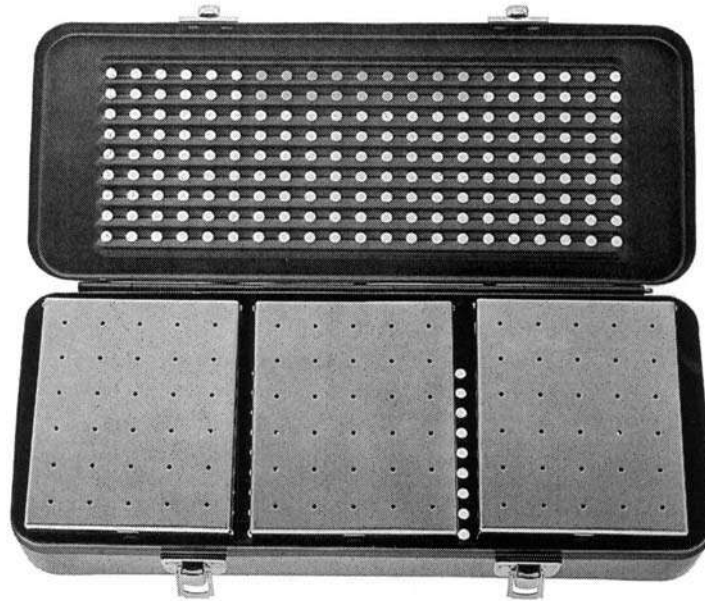

DSA-16-250 Aluminum Case (without racks)

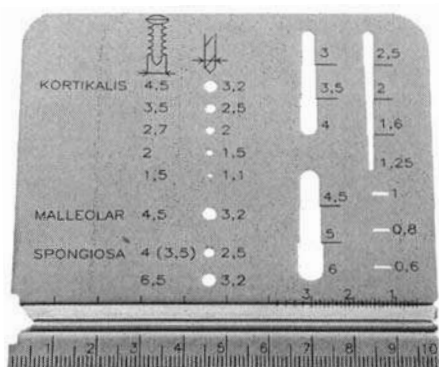

16-255 Measuring Gauge for Screws



- 16-260** Rack for \varnothing 1.5 mm Screws
- 16-265** Rack for \varnothing 2.0 mm Screws
- 16-270** Rack for \varnothing 2.7 mm Screws
- 16-275** Rack for \varnothing 3.5 mm 1.25 Pitch Screws
- 16-280** Rack for \varnothing 3.5 mm 1.75 Pitch Screws
- 16-285** Rack for \varnothing 4.0 mm Screws (half Threaded)
- 16-290** Rack for \varnothing 4.0 mm Screws (full Threaded)
- 16-295** Rack for \varnothing 4.5 mm Screws

18/10
Stainless Steel



16-300 Sauerbruch 210 x 125 x 17 mm

Instrument Cases

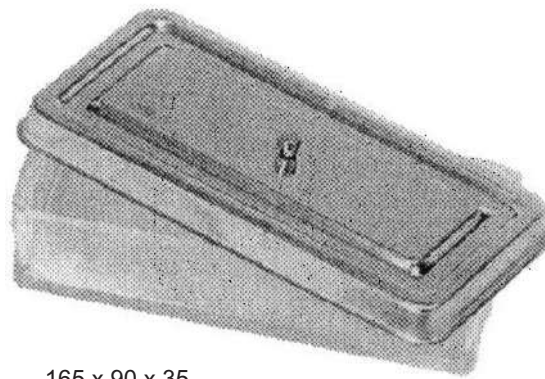

- 16-305** 165 x 90 x 35
- 16-310** 200 x 100 x 50
- 16-315** 220 x 150 x 50
- 16-320** 260 x 150 x 50
- 16-325** 305 x 205 x 50

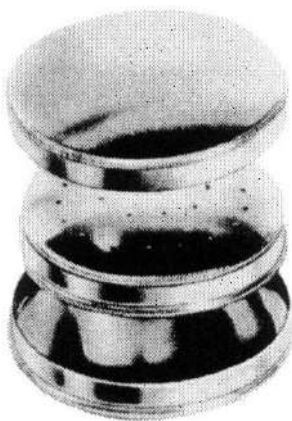

16-330 65 x 15 mm



16-335

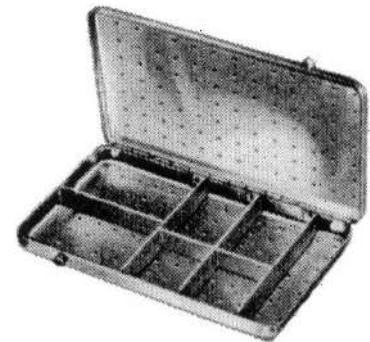

16-340 150 x 95 x 13 mm

Plaster Instruments



194-195-23 Lorenz
23,0 cm

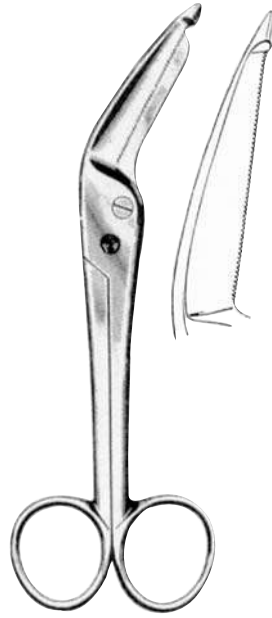

194-200-19 Lister
Exentric 19,0 cm



194-215-20 20,0 cm



194-223-23 Bergmann
23,0 cm



194-230-14 Lister 140 mm
194-230-18 180 mm
194-230-20 200 mm

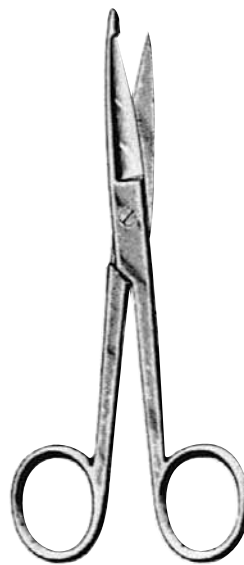

194-155-14
Knowles
140 m m

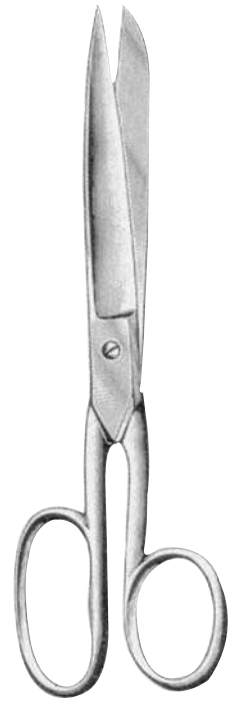

194-240-19 Smith Mod USA 18,0 cm
194-240-20 20,0 cm
194-240-23 23,0 cm

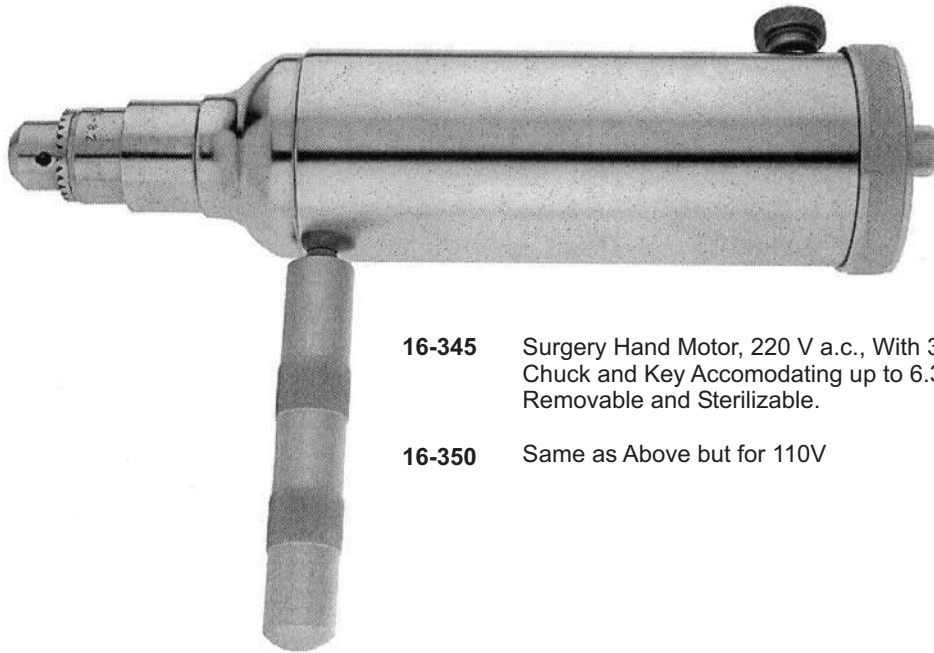

16-345 Surgery Hand Motor, 220 V a.c., With 3 - Jaw Chuck and Key Accomodating up to 6.35mm, Removable and Sterilizable.

16-350 Same as Above but for 110V

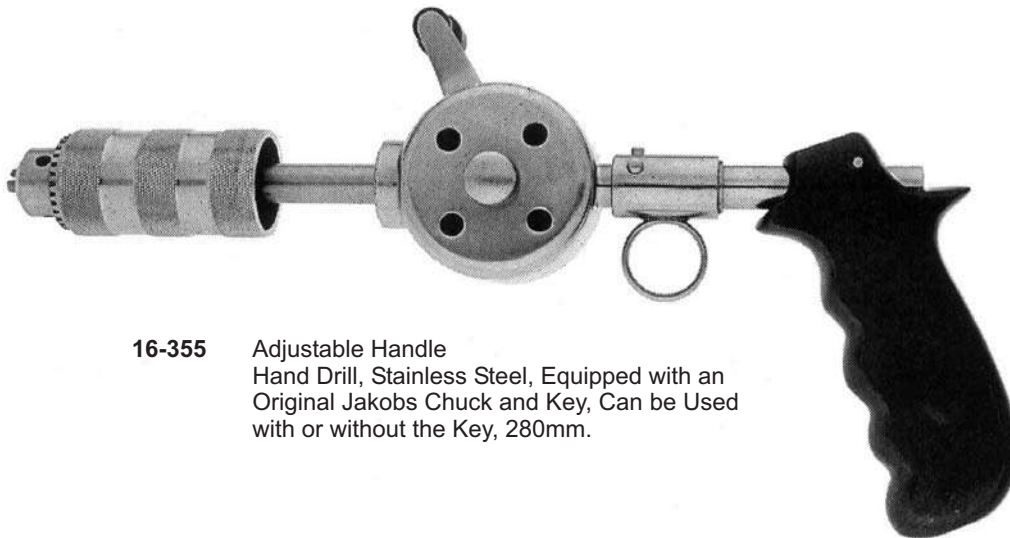

16-355 Adjustable Handle Hand Drill, Stainless Steel, Equipped with an Original Jakobs Chuck and Key, Can be Used with or without the Key, 280mm.

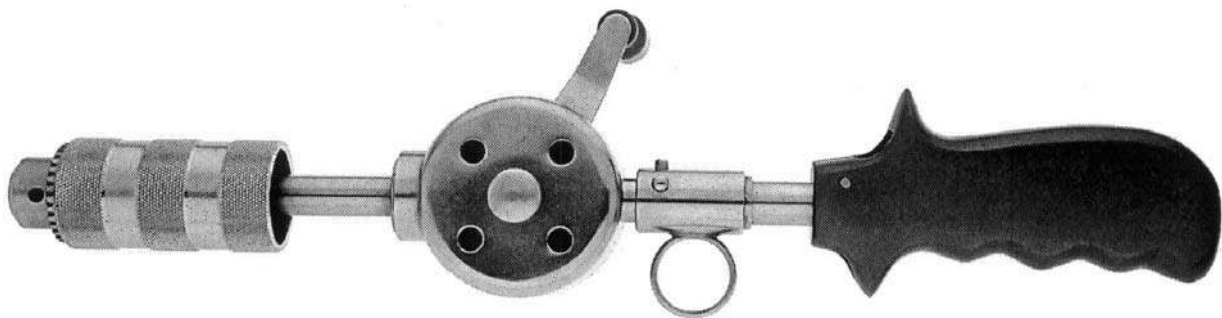

16-360 Adjustable Handle Hand Drill, Stainless Steel, As Above, but Equipped with an Original Jakobs Chuck and Key, Can be Used with or without the Key, 280mm.

WE HAVE ALL RANGE OF INSTRUMENTS



CONTACT INFO



+92-340 0473111



swisons.ind@gmail.com



www.swisons.com



Small Industrial Estate, Sialkot 51310 Pakistan

Get your high quality Instruments